



Chipsmall Limited consists of a professional team with an average of over 10 year of expertise in the distribution of electronic components. Based in Hongkong, we have already established firm and mutual-benefit business relationships with customers from,Europe,America and south Asia,supplying obsolete and hard-to-find components to meet their specific needs.

With the principle of “Quality Parts,Customers Priority,Honest Operation,and Considerate Service”,our business mainly focus on the distribution of electronic components. Line cards we deal with include Microchip,ALPS,ROHM,Xilinx,Pulse,ON,Everlight and Freescale. Main products comprise IC,Modules,Potentiometer,IC Socket,Relay,Connector.Our parts cover such applications as commercial,industrial, and automotives areas.

We are looking forward to setting up business relationship with you and hope to provide you with the best service and solution. Let us make a better world for our industry!



Contact us

Tel: +86-755-8981 8866 Fax: +86-755-8427 6832

Email & Skype: info@chipsmall.com Web: www.chipsmall.com

Address: A1208, Overseas Decoration Building, #122 Zhenhua RD., Futian, Shenzhen, China



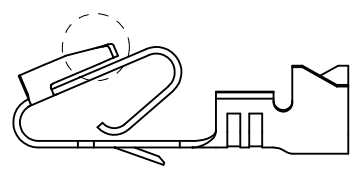

ALTERNATE GEOMETRY
SEE NOTE 10

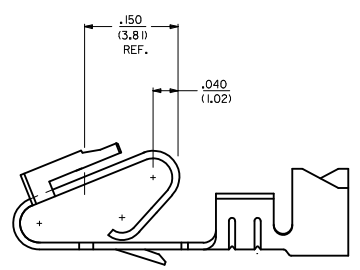

SELECTIVE PLATING
LOCATION

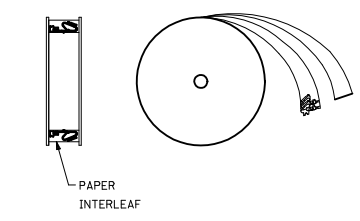

WINDING DETAIL 'A'

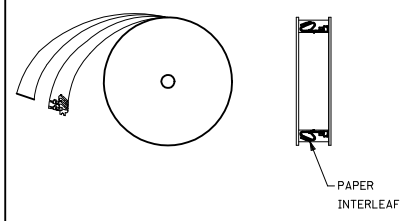

WINDING DETAIL 'B'

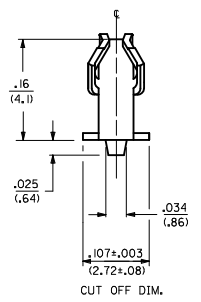
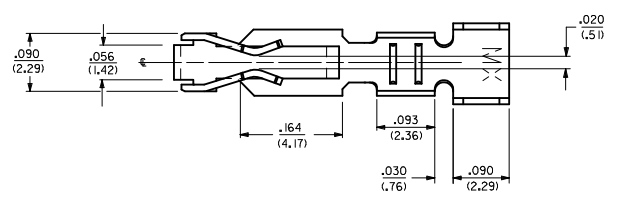

CUT OFF DIM.

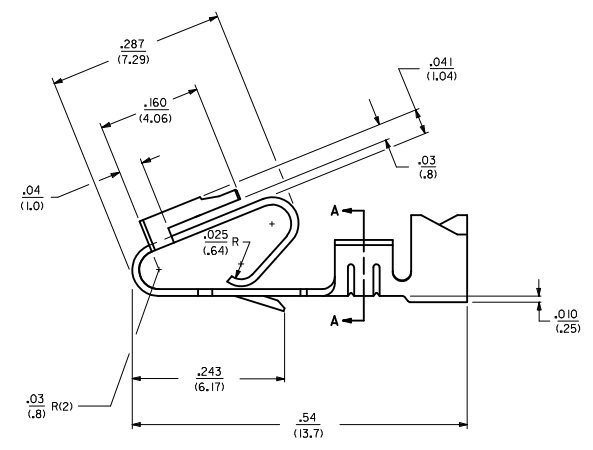

- NOTES:
1. MATERIAL: SEE LEGEND
 2. FINISH:
909 - OVERALL HOT TIN DIP: .000100/(0.00254) MIN.
154 - OVERALL TIN: .000100/(0.00254) MIN. OVER .000050/(0.00127) MIN. NICKEL.
555 - SELECT HARD GOLD: .000015/(0.00038) MIN. OVERALL NICKEL: .000030/(0.00076) MIN.
558 - SELECT HARD GOLD: .000030/(0.00076) MIN. OVERALL NICKEL: .000050/(0.00127) MIN.
OVERALL HARD GOLD FLASH: .000002/(0.00005) MIN.
561 - SELECT HARD GOLD: .000030/(0.00076) MIN. OVERALL NICKEL: .000050/(0.00127) MIN.
 3. PRODUCT SPECIFICATION: PS-40-02
 4. PACKAGING SPECIFICATION: CHAIN FORM: SEE PK-6838-001
LOOSE FORM: SEE PK-2759-001
 5. TERMINAL FOR USE IN HOUSING SERIES 6442 AND 41695.
 6. SEE 7258 SERIES FOR THIS PART WITH CRIMP FOR 22-26 AWG. WIRE.
 7. CRIMP FOR 18 TO 20 GA. WIRE WITH MAX. INSULATION DIA. OF .100(2,79). STRIP LENGTH OF .125/100 / (3,18/2,54)
 8. DIMENSIONS GIVEN ACROSS CENTERLINES ARE SYMMETRICAL ABOUT THOSE CENTERLINES WITHIN HALF THE TOTAL TOLERANCE.
 9. THIS PART CONFORMS TO CLASS B REQUIREMENTS OF COSMETIC SPECIFICATION PS-45499-002.
 10. ALTERNATE GEOMETRY PRESENT ON SOME PART NUMBERS. SEE SHEET 2.

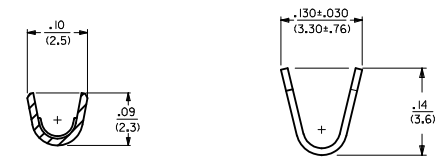

SECTION A-A

LEGEND: 6838- ()

MATERIAL:
(.271/.0106 THK
BLANK=BRASS
A=PHOS BRONZE

WINDING
A= PER DETAIL A
BLANK= PER DETAIL B

FORM
BLANK= CHAIN
L= LOOSE

PLATING
SEE NOTE 2

102 TO 154 PLTIG. IEC NO. UCF2012-1821 DRAWN BY: DRW/MSTROH 2012/01/04 CHECKED BY: CHY/DK/PPER 2012/01/05 APPROVED BY: APPR/FSM/TH 2012/02/02 AR	QUALITY SYMBOLS	GENERAL TOLERANCES (UNLESS SPECIFIED)	DIMENSION STYLE	SCALE	DESIGN UNITS	THIRD ANGLE PROJECTION
	▽=0	mm INCH	IN/MM	---	INCH	☉
	▽=0	4 PLACES ± --- ± ---	DRAWN BY DATE	---	---	---
	▽=0	3 PLACES ± --- ± .010	GUZIK 11/15/89	---	---	---
	2 PLACES ± 0.25 ± .015	CHECKED BY DATE	---	---	---	---
	1 PLACE ± 0.36 ± ---	PATEL 11/15/89	---	---	---	---
	ANGULAR ±1/2°	APPROVED BY DATE	---	---	---	---
		LENZ 11/15/89	---	---	---	---
	DRAFT WHERE APPLICABLE MUST REMAIN WITHIN DIMENSIONS	MATERIAL NO.	---	---	---	---
		SEE CHART	---	---	---	---
		DOCUMENT NO.	---	---	---	---
		SD-6838	---	---	---	---
		1 OF 2	---	---	---	---

20 19 18 17 16 15 14 13 12 11 10 9 8 7 6 5 4 3 2 1

6838-(*)**

PART NO.	ENG. NO.	
08-50-0187	6838-(P909)	SEE NOTE 1
08-50-0189	6838-(P909)L	SEE NOTE 1
08-50-0275	6838-(P909)-A	

6838-A(*)**

PART NO.	ENG. NO.	
08-58-0187	6838-A(P558)	
08-58-0189	6838-A(P558)L	
08-52-0112	6838-A(P909)	SEE NOTE 1
08-52-0113	6838-A(P909)L	SEE NOTE 1
08-50-0024	6838-A(154)	
08-50-0251	6838-A(154)L	
08-58-0105	6838-A(P555)	
08-58-0106	6838-A(P555)L	
08-58-0110	6838-A(P56 I)	SEE NOTE 1
08-58-0111	6838-A(P56 I)L	SEE NOTE 1
08-58-0118	6838-A(56 I)	
08-58-0119	6838-A(56 I)L	

NOTES:

1. PART MANUFACTURED WITH ALTERNATE GEOMETRY. SEE SHEET 1.

SEE SHEET 1 IEC NO: UCF2012-1821 DRAWN BY: DRW:MMSTROH 2012/01/04 CHECKED BY: CHY:KH/KIPFER 2012/01/05 APPROVED BY: APPR:FSM/TH 2012/02/02	QUALITY SYMBOLS	GENERAL TOLERANCES (UNLESS SPECIFIED)	DIMENSION STYLE	SCALE	DESIGN UNITS	THIRD ANGLE PROJECTION	
	▽=0	mm INCH	IN/MM	---	INCH	☉	
	▽=0	4 PLACES #--- #--- 3 PLACES #--- #--- 2 PLACES #--- #--- 1 PLACE #--- #---		DRAWN BY DATE GUZIK 11/15/89			TITLE TRIFURCON TERMINAL CRIMP TYPE, .156 CENTERS 18 TO 20 AWG WIRE
	▽=0	ANGULAR ±1/2°		CHECKED BY DATE PATEL 11/15/89			MOLEX INCORPORATED
	DRAFT WHERE APPLICABLE MUST REMAIN WITHIN DIMENSIONS		APPROVED BY DATE LENZ 11/15/89			MATERIAL NO. SEE CHART	
						DOCUMENT NO. SD-6838	
						SHEET NO. 2 OF 2	
						THIS DRAWING CONTAINS INFORMATION THAT IS PROPRIETARY TO MOLEX INCORPORATED AND SHOULD NOT BE USED WITHOUT WRITTEN PERMISSION	

19 18 17 16 15 14 13 12 11 10 9 8 7 6 5 4 3 2 1