



Chipsmall Limited consists of a professional team with an average of over 10 year of expertise in the distribution of electronic components. Based in Hongkong, we have already established firm and mutual-benefit business relationships with customers from,Europe,America and south Asia,supplying obsolete and hard-to-find components to meet their specific needs.

With the principle of “Quality Parts,Customers Priority,Honest Operation,and Considerate Service”,our business mainly focus on the distribution of electronic components. Line cards we deal with include Microchip,ALPS,ROHM,Xilinx,Pulse,ON,Everlight and Freescale. Main products comprise IC,Modules,Potentiometer,IC Socket,Relay,Connector.Our parts cover such applications as commercial,industrial, and automotives areas.

We are looking forward to setting up business relationship with you and hope to provide you with the best service and solution. Let us make a better world for our industry!



Contact us

Tel: +86-755-8981 8866 Fax: +86-755-8427 6832

Email & Skype: info@chipsmall.com Web: www.chipsmall.com

Address: A1208, Overseas Decoration Building, #122 Zhenhua RD., Futian, Shenzhen, China



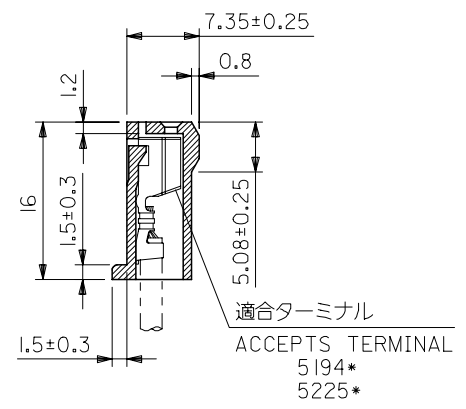
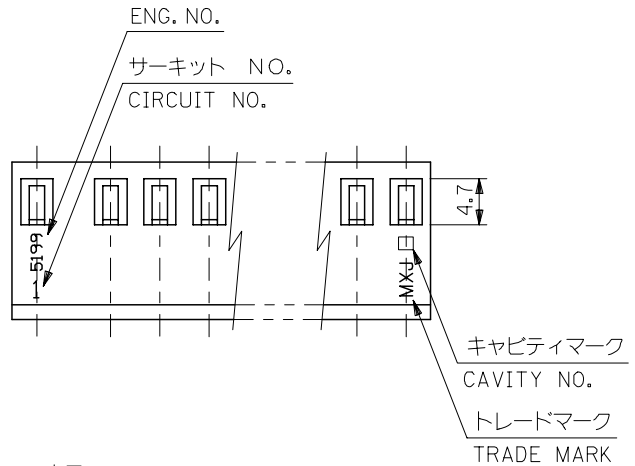
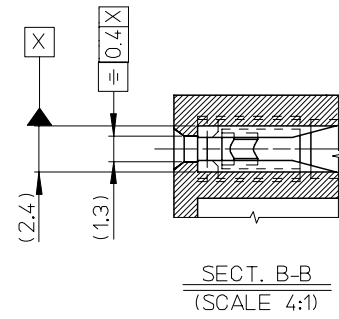
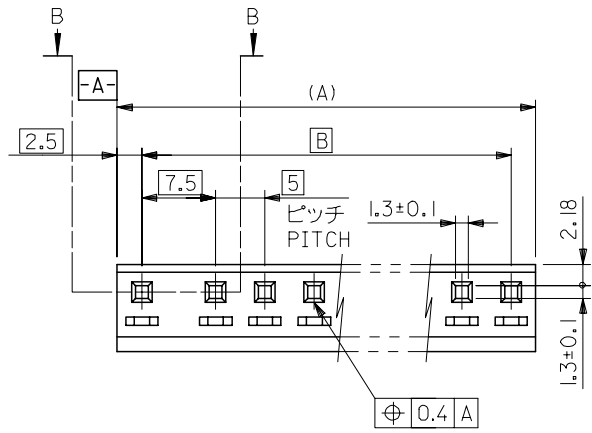

注) NOTE.
 1. 各部のそりは0.5最大 WARPING:0.5MAX.
 2. サーキットNO. はNO. " 1" のみ表示
 CIRCUIT NO. : "I" ONLY

10-63-3064	5199-06	27.5	32.5	6
▲-3054	▲-05	22.5	27.5	5
▼-3044	▼-04	17.5	22.5	4
▼-3034	▼-03	12.5	17.5	3
10-63-3024	5199-02	7.5	12.5	2
EDP.NO.	ENG.NO.	B	(A)	極数 CKT.

REVISED EC NO: J2007-3407 DRAWN:TKON 2007/06/20 CHK:DM SOGAYA 2007/06/25 APPR:THARUYAMA 2007/06/25	GENERAL TOLERANCES (UNLESS SPECIFIED)		DIMENSION STYLE MM ONLY		SCALE 2:1	DESIGN UNITS METRIC	THIRD ANGLE PROJECTION
	10 UNDER	±0.2	DRAWN BY DATE K.KOHAMA 2000/03/28		TITLE SPOX 5/7.5 PITCH REC HSG		
	10 OVER 30 UNDER	±0.25	CHECKED BY DATE T.YAMAGUCHI 2000/03/30		MOLEX INCORPORATED		
	30 OVER	±0.3	APPROVED BY DATE M.FUKUSHIMA 2000/03/30		DOCUMENT NO. SD-5199-001	SHEET NO. 1 OF 1	
	ANGULAR ±3 °	DRAFT WHERE APPLICABLE MUST REMAIN WITHIN DIMENSIONS		MATERIAL NO. SEE TABLE			
J	SIZE A3 THIS DRAWING CONTAINS INFORMATION THAT IS PROPRIETARY TO MOLEX INCORPORATED AND SHOULD NOT BE USED WITHOUT WRITTEN PERMISSION						

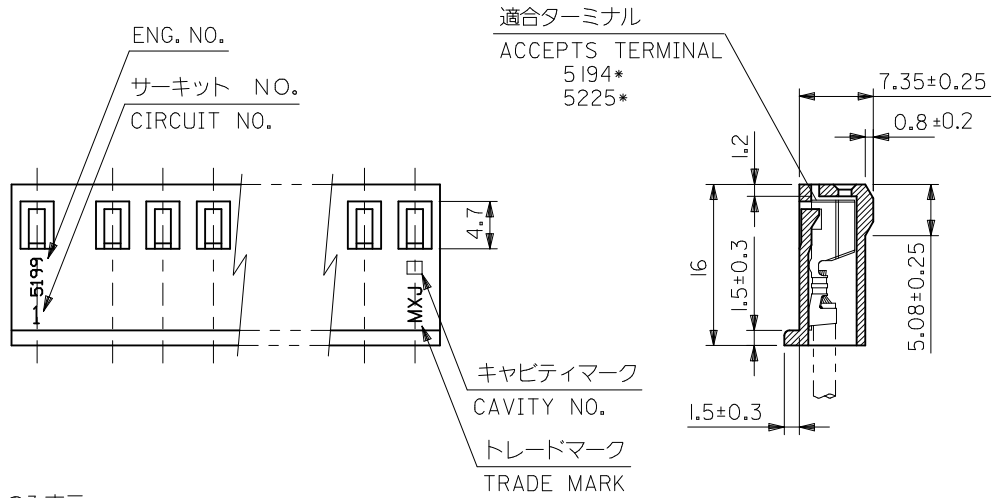
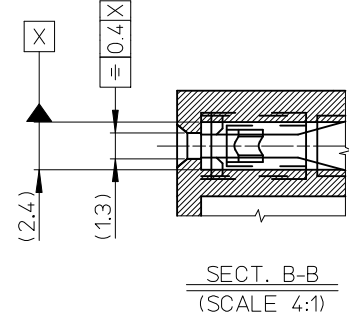
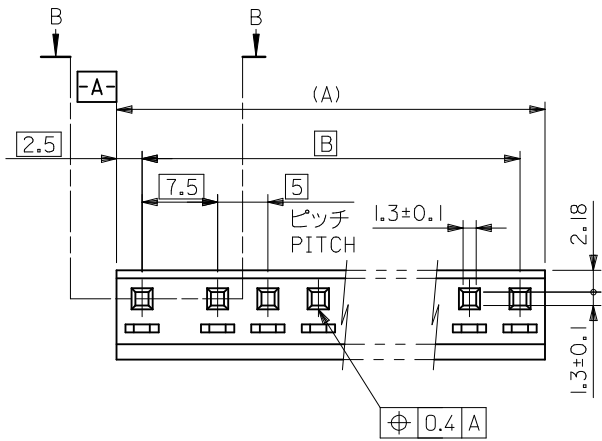

注) NOTE.
 1. 各部のそりは0.5最大 WARPING:0.5MAX.
 2. サーキットNO. はNO. ° 1° のみ表示
 CIRCUIT NO. : "I" ONLY

39024020	5199-02-BL	BLACK	7.5	12.5	2
39024021	5199-02-BU	BLUE			
39024022	5199-02-RE	RED			
10633024	5199-02	NATURAL			
ORDER NO.	ENG.NO.	COLOR	B	(A)	種数 CKT.

RELEASED EC NO.: J2016-0780 DRWN: SSIHIMONISHI 2016/01/22 CHKD: KOMURAKAMI 2016/01/22 APPR: KANEKO 2016/01/22	GENERAL TOLERANCES (UNLESS SPECIFIED)		DIMENSION STYLE		SCALE	DESIGN UNITS	THIRD ANGLE PROJECTION
	0.25 UNDER UNDER ±0.03		MM ONLY		2:1	METRIC	
	0.25 OVER 0.5 UNDER ±0.05		DRAWN BY DATE		TITLE		
	0.5 OVER 1.0 UNDER ±0.1		K. KOHAMA 2000/03/28		SPOX 5/7.5 PITCH REC HSG		
	1.0 OVER 10 UNDER ±0.2		CHECKED BY DATE		DOCUMENT NO.		
10 OVER 30 UNDER ±0.25		T. YAMAGUCHI 2000/03/30		SD-5199-003		SHEET NO.	
30 OVER ±0.3		APPROVED BY DATE		MATERIAL NO.		1 OF 1	
ANGULAR ±3 °		TKANEKO 2016/01/22		SEE CHART			
DRAFT WHERE APPLICABLE MUST REMAIN WITHIN DIMENSIONS		SIZE		THIS DRAWING CONTAINS INFORMATION THAT IS PROPRIETARY TO MOLEX ELECTRONIC TECHNOLOGIES, LLC AND SHOULD NOT BE USED WITHOUT WRITTEN PERMISSION			
O		A3					