



Chipsmall Limited consists of a professional team with an average of over 10 year of expertise in the distribution of electronic components. Based in Hongkong, we have already established firm and mutual-benefit business relationships with customers from,Europe,America and south Asia,supplying obsolete and hard-to-find components to meet their specific needs.

With the principle of “Quality Parts,Customers Priority,Honest Operation,and Considerate Service”,our business mainly focus on the distribution of electronic components. Line cards we deal with include Microchip,ALPS,ROHM,Xilinx,Pulse,ON,Everlight and Freescale. Main products comprise IC,Modules,Potentiometer,IC Socket,Relay,Connector.Our parts cover such applications as commercial,industrial, and automotives areas.

We are looking forward to setting up business relationship with you and hope to provide you with the best service and solution. Let us make a better world for our industry!



Contact us

Tel: +86-755-8981 8866 Fax: +86-755-8427 6832

Email & Skype: info@chipsmall.com Web: www.chipsmall.com

Address: A1208, Overseas Decoration Building, #122 Zhenhua RD., Futian, Shenzhen, China



CKT. SIZE	OPTION A (WITHOUT RIBS)		OPTION B (WITH RIBS)		DIMENSION	
	EDP. NO.	ENG. NO.	EDP. NO.	ENG. NO.	A	B
	4	NOT TOOLED	X-70013-0008	NOT TOOLED	X-70013-1004	(5.33) .210
6	015-04-5061	70013-0001	015-04-5064	70013-1006	(7.87) .310	(5.08) .200
8	015-04-5081	70013-0007	015-04-5084	70013-1008	(10.41) .410	(7.62) .300
10	015-04-5101	70013-0002	015-04-5104	70013-1010	(12.95) .510	(10.16) .400
12	015-04-5121	70013-0012	015-04-5124	70013-1012	(15.49) .610	(12.70) .500
14	015-04-5141	70013-0014	015-04-5144	70013-1014	(18.03) .710	(15.24) .600
16	015-04-5161	70013-0016	015-04-5164	70013-1016	(20.57) .810	(17.78) .700
18	015-04-5181	70013-0018	015-04-5184	70013-1018	(23.11) .910	(20.32) .800
20	015-04-5201	70013-0003	015-04-5204	70013-1020	(25.65) 1.010	(22.86) .900
22	015-04-5221	70013-0022	015-04-5224	70013-1022	(28.19) 1.110	(25.40) 1.000
24	015-04-5241	70013-0024	015-04-5244	70013-1024	(30.73) 1.210	(27.94) 1.100
26	015-04-5261	70013-0026	015-04-5264	70013-1026	(33.27) 1.310	(30.48) 1.200
28	015-04-5281	70013-0028	015-04-5284	70013-1028	(35.81) 1.410	(33.02) 1.300
30	015-04-5301	70013-0004	015-04-5304	70013-1030	(38.35) 1.510	(35.56) 1.400
32	015-04-5321	70013-0032	015-04-5324	70013-1032	(40.89) 1.610	(38.10) 1.500
34	015-04-5341	70013-0034	015-04-5344	70013-1034	(43.43) 1.710	(40.64) 1.600
36	015-04-5361	70013-0036	015-04-5364	70013-1036	(45.97) 1.810	(43.18) 1.700
38	015-04-5381	70013-0038	015-04-5384	70013-1038	(48.51) 1.910	(45.72) 1.800
40	015-04-5401	70013-0005	015-04-5404	70013-1040	(51.05) 2.010	(48.26) 1.900
42	015-04-5421	70013-0042	015-04-5424	70013-1042	(53.59) 2.110	(50.80) 2.000
44	015-04-5441	70013-0044	015-04-5444	70013-1044	(56.13) 2.210	(53.34) 2.100
46	015-04-5461	70013-0046	015-04-5464	70013-1046	(58.67) 2.310	(55.88) 2.200
48	015-04-5481	70013-0048	015-04-5484	70013-1048	(61.21) 2.410	(58.42) 2.300
50	015-04-5501	70013-0006	015-04-5504	70013-1050	(63.75) 2.510	(60.96) 2.400

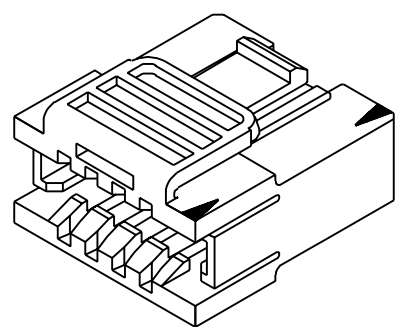
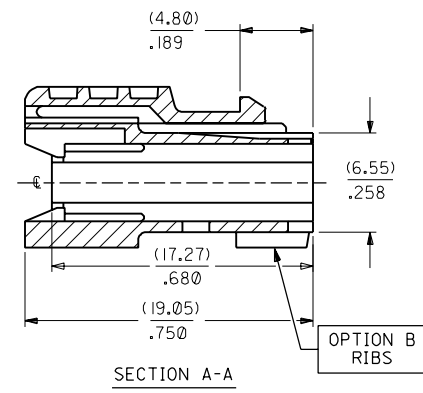
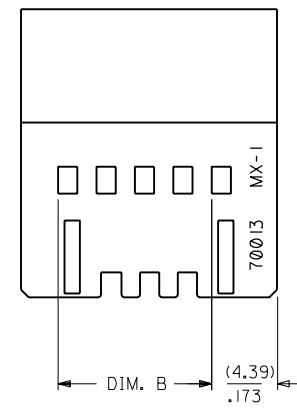
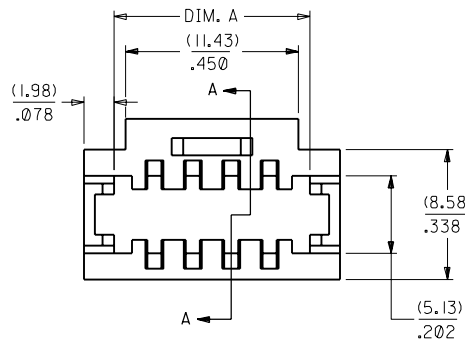
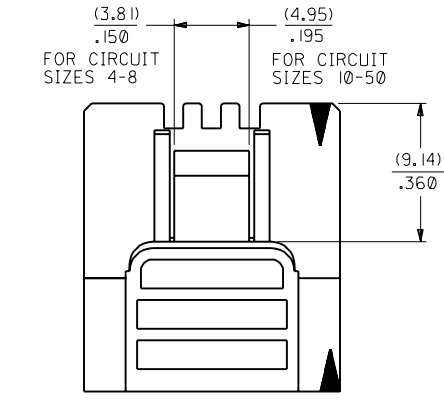
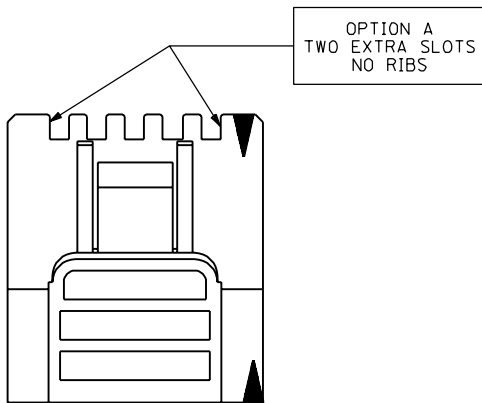

- NOTES:
- 1) MATERIAL: GLASS FILLED POLYESTER, 94V-0, BLACK
 - 2) MOLD TO BE EXPANDABLE FOR CIRCUIT SIZES LISTED ON CHART.
 - 3) 10 CIRCUIT, B OPTION PART SHOWN.
 - 4) OPTION "A" - MATES WITH HEADERS 8723-B, 8723-C, 8724-B, 8724-C, 70227, 70229, AND 70022. OPTION "B" - MATES WITH HEADERS 8723-C, 8724-C, 70227, 700229, AND 70022 (EXCEPT THE 50 CIRCUIT PARTS LISTED ON PAGE 4. SEE THE CHART ON PAGE 4 FOR MATING INTERIM CLIPS)
 - 5) ALL DIMENSIONS FOR REFERENCE ONLY.
 - 6) OPTIONAL SPRING CLIP FOR GREATER RETENTION OF MODULES IS RECOMMENDED FOR CIRCUIT SIZES 18-50. PART NUMBER 71809.
 - 7) PACKAGE PER PK-70013-100.

M	ADD PKG NOTE ECN UDT2000-0468 SCHAFFER 99/12/1	LI	REVISE PER ECR #U80583 10/10/97 HPA	DIMENSIONS SHOWN (METRIC) INCH UNLESS OTHERWISE SPECIFIED TOLERANCES: ANGULAR ± 1/2°	▽ = 0 ▼ = 0	REVISE ONLY ON CAD SYSTEM
L3	CLEAN UP DWG PER UDT1999-0522 99/01/05 KAS	L	REVISE PER ECR #U80062 3/1/88 MJM	INCH METRIC 5 PLACE ± .010 --- 2 PLACE ± .015 ± 0.25 1 PLACE --- ± 0.38	TITLE DUAL ROW INTERIM CLIP .100 GRID	
L2	REVISE PER ECR #UDT1998-0206 98/01/09 HPA	K	REVISE TOP WALL & ANTI-FISH HOOK RIBS PER ECR#9622 1/17/87 MJM/JAS	DRAFT WHERE APPLICABLE MUST REMAIN WITHIN DIMENSIONS		MOLEX INCORPORATED L1SLE,ILL. 60532 U.S.A.
LTR.	REVISIONS	LTR.	REVISIONS	DRWG. NO. SD-70013-0001-1050	SHEET NO. 1 OF 4	DATE 06/23/86
				DRWG. BY DJB	CHK'D. BY DB	FILE NAME ST0013X1
				APP'D. BY WZ	SCALE 4:1	THIS DRAWING CONTAINS INFORMATION THAT IS PROPRIETARY TO MOLEX INC. AND SHOULD NOT BE USED WITHOUT WRITTEN PERMISSION.

4	L2
3	L1
2	L3
1	M
MFG. SH. REV.	

4 CKT.

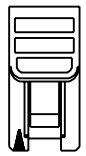

6 CKT.
3 CKT. DUAL
ROW - ODD

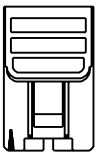

8 CKT.
4 CKT. DUAL
ROW - EVEN

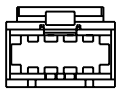
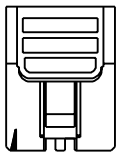

10 CKT.
SHOWN
ON SHT. 1

12 CKT.
6 CKT. DUAL
ROW - EVEN

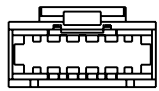
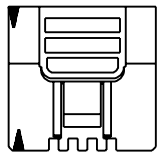

14 CKT.
7 CKT. DUAL
ROW - ODD

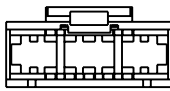
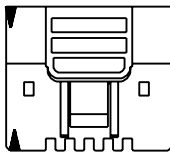

16 CKT.
8 CKT. DUAL
ROW - EVEN

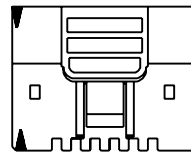

18 CKT.
9 CKT. DUAL
ROW - ODD

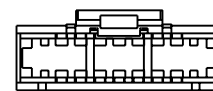
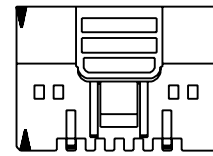

20 CKT.
10 CKT. DUAL
ROW - EVEN

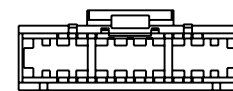
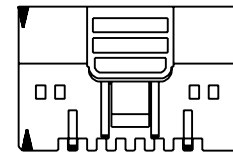

22 CKT.
11 CKT. DUAL
ROW - ODD

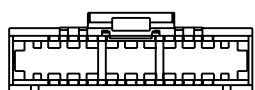
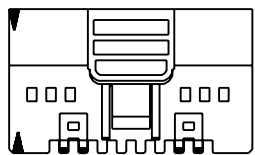

24 CKT.
12 CKT. DUAL
ROW - EVEN

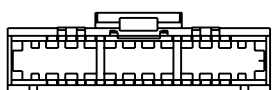
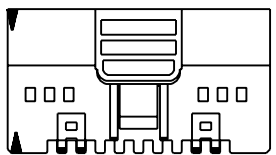

26 CKT.
13 CKT. DUAL
ROW - ODD

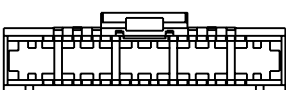
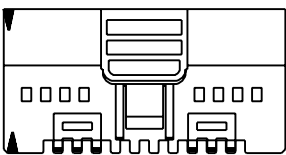

28 CKT.
14 CKT. DUAL
ROW - EVEN

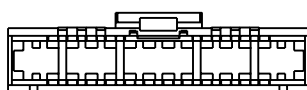
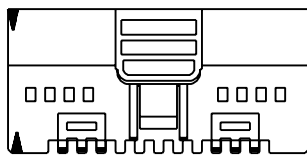

30 CKT.
15 CKT. DUAL
ROW - ODD

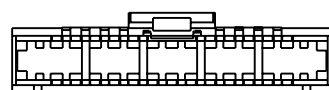
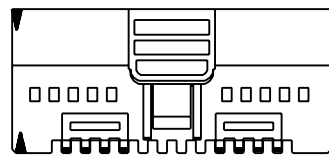

32 CKT.
16 CKT. DUAL
ROW - EVEN

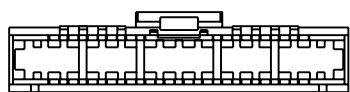
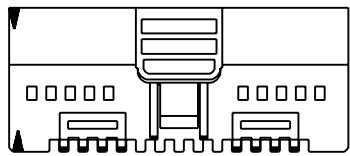

34 CKT.
17 CKT. DUAL
ROW - ODD

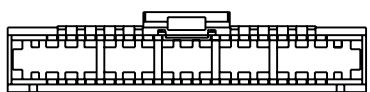
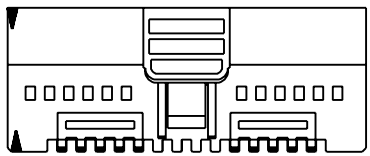

36 CKT.
18 CKT. DUAL
ROW - EVEN

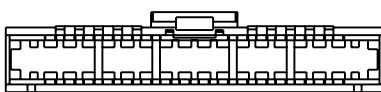

L3	SEE SHEET 1
L	SEE SHEET 1
L	SEE SHEET 1
K	SEE SHEET 1
J	SEE SHEET 1

DIMENSIONS SHOWN (METRIC) INCH		▽ = 0		◻ = 0		REVISE ONLY ON CAD SYSTEM	
UNLESS OTHERWISE SPECIFIED TOLERANCES ANGULAR ± 1/2°							
		INCH		METRIC			
3 PLACE	± .010	---		---			
2 PLACE	± .015	± 0.25		---			
1 PLACE	---	± 0.38		---			
DRAWING WHERE APPLICABLE MUST REMAIN WITHIN DIMENSIONS							
DRWG. BY: DJB	CHK'D BY: DB	FILE NAME: S70013X2		DIV.:		SIZE:	
SCALE: 2:1		THIS DRAWING CONTAINS INFORMATION THAT IS PROPRIETARY TO MOLEX INC. AND SHOULD NOT BE USED WITHOUT WRITTEN PERMISSION.		DATE: 06/25/86		SHEET NO. 2	
SEE CHART				SD-70013-0001-1050			
PART NO. MOLEX INCORPORATED U.S.A. 69532				DRWG. NO. 1515E.I.L.L.			