



Chipsmall Limited consists of a professional team with an average of over 10 year of expertise in the distribution of electronic components. Based in Hongkong, we have already established firm and mutual-benefit business relationships with customers from,Europe,America and south Asia,supplying obsolete and hard-to-find components to meet their specific needs.

With the principle of “Quality Parts,Customers Priority,Honest Operation,and Considerate Service”,our business mainly focus on the distribution of electronic components. Line cards we deal with include Microchip,ALPS,ROHM,Xilinx,Pulse,ON,Everlight and Freescale. Main products comprise IC,Modules,Potentiometer,IC Socket,Relay,Connector.Our parts cover such applications as commercial,industrial, and automotives areas.

We are looking forward to setting up business relationship with you and hope to provide you with the best service and solution. Let us make a better world for our industry!



Contact us

Tel: +86-755-8981 8866 Fax: +86-755-8427 6832

Email & Skype: info@chipsmall.com Web: www.chipsmall.com

Address: A1208, Overseas Decoration Building, #122 Zhenhua RD., Futian, Shenzhen, China



LEGEND:

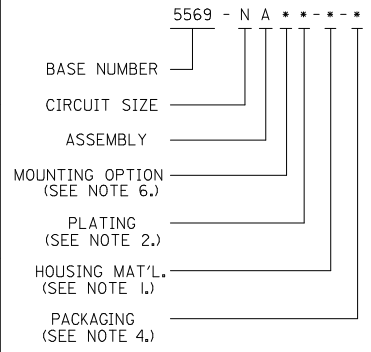

CIRCUIT SIZE	DIM. "A"	DIM. "B"
6	.54 (13.8)	.33 (8.4)
8	.71 (18.0)	.50 (12.6)
10	.87 (22.2)	.66 (16.8)
12	1.04 (26.4)	.83 (21.0)
14	1.20 (30.6)	.99 (25.2)
16	1.37 (34.8)	1.16 (29.4)
18	1.54 (39.0)	1.32 (33.6)
20	1.70 (43.2)	1.49 (37.8)
22	1.87 (47.4)	1.65 (42.0)
24	2.03 (51.6)	1.82 (46.2)

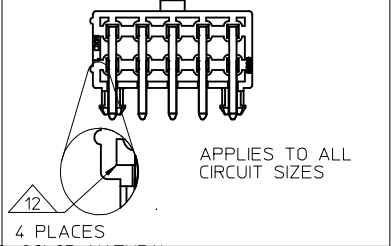
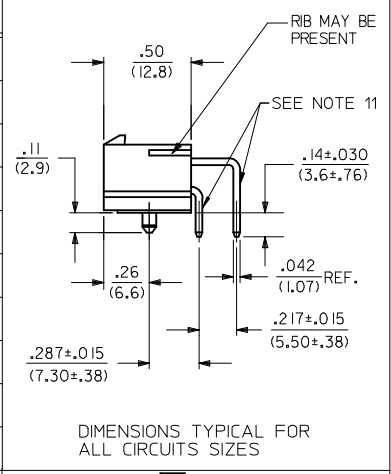

- NOTES:**
- MATERIAL:**
HOUSING:
"BLANK" = NYLON (PA66), LOW HALOGEN, UNFILLED, UL94V-2, COLOR: NATURAL
"BL" = NYLON (PA66), LOW HALOGEN, UNFILLED, UL94V-2, COLOR: BLACK
"210" = NYLON (PA66), LOW HALOGEN, UNFILLED, UL94V-0, COLOR: NATURAL
"400" = NYLON (PA66), LOW HALOGEN, UNFILLED, UL94V-0, COLOR: BLACK
TERMINAL:
BRASS ALLOY
 - FINISH (PLATING):**
G, GS = .000030/(0.00076) MIN. SELECT GOLD OVER .000100/(0.00254) MIN. SELECT MATTE TIN OVER .000050/(0.00127) MIN. NICKEL OVERALL
GS2 = .000015/(0.00038) MIN. SELECT GOLD OVER .000100/(0.00254) MIN. SELECT MATTE TIN OVER .000050/(0.00127) MIN. NICKEL OVERALL
GS3 = .000050/(0.00127) MIN. SELECT GOLD OVER .000100/(0.00254) MIN. SELECT MATTE TIN OVER .000050/(0.00127) MIN. NICKEL OVERALL
BLANK, S, MS = .000100/(0.00254) MIN. MATTE TIN OVER .000050/(0.00127) MIN. NICKEL OVERALL
RM = .000060/(0.00152) MIN. REFLOWED MATTE TIN OVER .000050/(0.00127) MIN. NICKEL OVERALL
 - PRODUCT SPECIFICATION:** PS-5556-001
 - PACKAGING:**
"BLANK" = BULK PACKED PER PK-5569-002 (NOT RECOMMENDED DUE TO SHIPPING AND HANDLING DAMAGE).
"T" = TRAY PACKED PER PK-5569-003 (RECOMMENDED FOR NEW APPLICATIONS)
 - PART MATES WITH MINI-FIT JR. RECEPTACLE SERIES 5557.**
 - MOUNTING OPTIONS:**
1 = SCREW MOUNT (SEE SD-5569-NA* SERIES DRAWING)
2 = PEG MOUNT
 - DISCOLORATION IN THE BANDOLIER CARRIER AREA OF THE PIN IS INHERENT TO THE PLATING PROCESS AND IS DUE TO THE MASKING EFFECT OF THE CARRIER. THIS DISCOLORATION IS IN A NON-FUNCTIONAL AREA OF THE PIN AND WILL NOT AFFECT THE PERFORMANCE OF THE HEADER ASSEMBLY.**
 - PART CONFORMS TO CLASS "B" REQUIREMENTS OF COSMETIC SPECIFICATION PS-45499-002.**
 - CONNECTORS ARE NOT TO BE MATED AND UNMATED WHILE CIRCUITS ARE LIVE.**
 - PARTS ARE NOT DESIGNED FOR CURRENT SHARING.**
 - FORMING MARKS ON PINS ARE ACCEPTABLE.**
 - CORNER CORE-OUTS ARE OPTIONAL AND MAY OR MAY NOT BE PRESENT.**

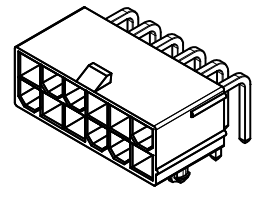
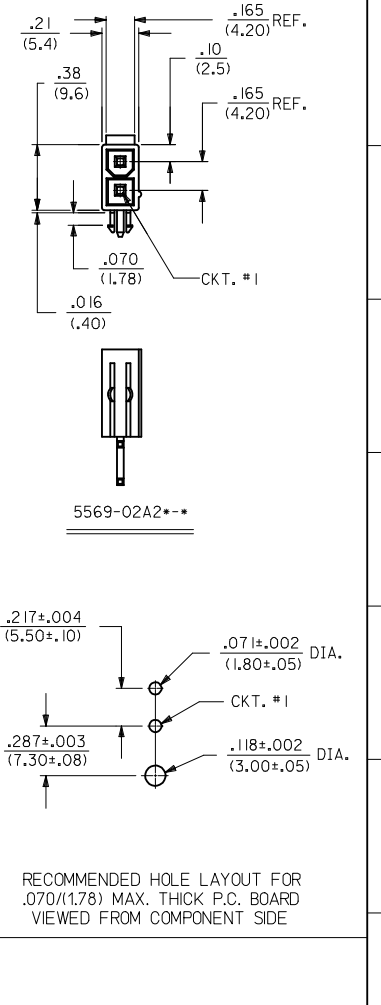
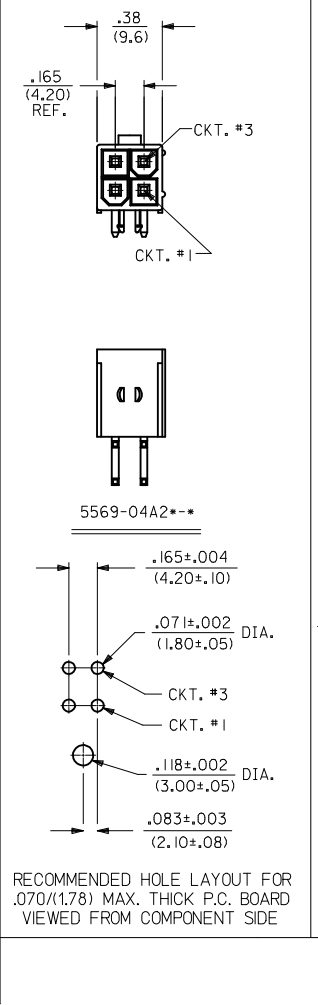
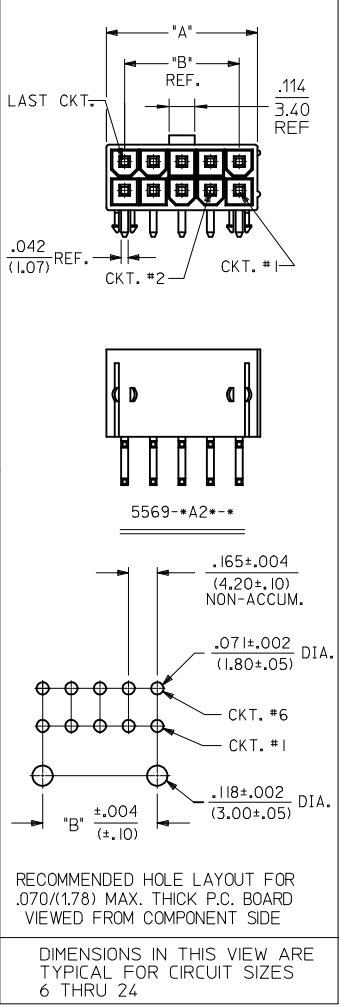

EDIT NOTE 4 EC NO: UCP2017-1294 DRWINGSLAFTER 2016/12/09 CHKD:JBELL 2016/12/09 APPR:FSM1TH 2016/12/20 DESCRIPTION	QUALITY SYMBOLS ∇=0 ∇=0 ∇=0	GENERAL TOLERANCES (UNLESS SPECIFIED)		DIMENSION STYLE IN/MM		SCALE 4:1	DESIGN UNITS METRIC	THIRD ANGLE PROJECTION		
		4 PLACES ± --- ± --- 3 PLACES ± --- ± .010 2 PLACES ± .25 ± .015 1 PLACE ± .38 ± --- 0 PLACE ± --- ± ---	mm INCH DRAWN BY DATE R/JF 1988/02/16 CHECKED BY DATE GT 1988/02/16 APPROVED BY DATE FSM1TH 2016/12/20	TITLE MINI-FIT JR RIGHT ANGLE HEADER ASSEMBLIES WITH MOUNTING PEGS		MATERIAL NO. SEE CHART		DOCUMENT NO. SDA-5569-NA2*-*	SHEET NO. 1 OF 1	
		ANGULAR ±1/2°		DRAFT WHERE APPLICABLE MUST REMAIN WITHIN DIMENSIONS		SIZE THIS DRAWING CONTAINS INFORMATION THAT IS PROPRIETARY TO MOLEX INCORPORATED AND SHOULD NOT BE USED WITHOUT WRITTEN PERMISSION				
		M10								

2-4	GENERAL DOCS.	M7
1	MEIO	M10
SHT.	SOFTWARE	REV.

TRAY PACKAGED PER PK-5569-003

PART NUMBER	ENG. NUMBER	CKT. SIZE	PLATING (NOTE 2)	HSG MATL	PART NUMBER	ENG. NUMBER	CKT. SIZE	PLATING (NOTE 2)	HSG MATL
26-01-3127	5569-02A2GS2-210-T	2	15 μ" SELECT GOLD SEE NOTE 2 OPTION "GS2"	94V-0	46999-0538	5569-02A2GS2-400-T	2	15 μ" SELECT GOLD SEE NOTE 2 OPTION "GS2"	BLACK 94V-0
26-01-3128	5569-04A2GS2-210-T	4			46999-0539	5569-04A2GS2-400-T	4		
NOT TOOLED	5569-06A2GS2-210-T	6			46999-0540	5569-06A2GS2-400-T	6		
NOT TOOLED	5569-08A2GS2-210-T	8			46999-0541	5569-08A2GS2-400-T	8		
NOT TOOLED	5569-10A2GS2-210-T	10			46999-0542	5569-10A2GS2-400-T	10		
NOT TOOLED	5569-12A2GS2-210-T	12			46999-0543	5569-12A2GS2-400-T	12		
NOT TOOLED	5569-14A2GS2-210-T	14			46999-0544	5569-14A2GS2-400-T	14		
NOT TOOLED	5569-16A2GS2-210-T	16			46999-0545	5569-16A2GS2-400-T	16		
NOT TOOLED	5569-18A2GS2-210-T	18			46999-0546	5569-18A2GS2-400-T	18		
NOT TOOLED	5569-20A2GS2-210-T	20			46999-0547	5569-20A2GS2-400-T	20		
NOT TOOLED	5569-22A2GS2-210-T	22			46999-0548	5569-22A2GS2-400-T	22		
NOT TOOLED	5569-24A2GS2-210-T	24			46999-0549	5569-24A2GS2-400-T	24		
26-01-3141	5569-02A2GS3-T	2			50 μ" SELECT GOLD SEE NOTE 2 OPTION "GS3"	94V-2			
26-01-3142	5569-04A2GS3-T	4					4		
26-01-3143	5569-06A2GS3-T	6					6		
26-01-3144	5569-08A2GS3-T	8					8		
NOT TOOLED	5569-10A2GS3-T	10					10		
NOT TOOLED	5569-12A2GS3-T	12					12		
NOT TOOLED	5569-14A2GS3-T	14					14		
26-01-3148	5569-16A2GS3-T	16					16		
NOT TOOLED	5569-18A2GS3-T	18					18		
NOT TOOLED	5569-20A2GS3-T	20					20		
NOT TOOLED	5569-22A2GS3-T	22					22		
NOT TOOLED	5569-24A2GS3-T	24			24				
46999-0001	5569-02A2S-BL-T	2	MATTE TIN OVER NICKEL SEE NOTE 2 OPTION "S"	BLACK 94V-2			2		
46999-0002	5569-04A2S-BL-T	4					4		
46999-0003	5569-06A2S-BL-T	6					6		
46999-0004	5569-08A2S-BL-T	8					8		
46999-0005	5569-10A2S-BL-T	10					10		
46999-0006	5569-12A2S-BL-T	12					12		
46999-0007	5569-14A2S-BL-T	14					14		
46999-0008	5569-16A2S-BL-T	16					16		
46999-0009	5569-18A2S-BL-T	18					18		
46999-0010	5569-20A2S-BL-T	20					20		
46999-0011	5569-22A2S-BL-T	22					22		
46999-0012	5569-24A2S-BL-T	24					24		
46999-0013	5569-02A2S-400-T	2	MATTE TIN OVER NICKEL SEE NOTE 2 OPTION "S"	BLACK 94V-0	46999-0515	5569-02A2G-400-T	2	30 μ" SELECT GOLD SEE NOTE 2 OPTION "G"	BLACK 94V-0
46999-0014	5569-04A2S-400-T	4			46999-0516	5569-04A2G-400-T	4		
46999-0015	5569-06A2S-400-T	6			46999-0517	5569-06A2G-400-T	6		
46999-0016	5569-08A2S-400-T	8			46999-0518	5569-08A2G-400-T	8		
46999-0017	5569-10A2S-400-T	10			46999-0519	5569-10A2G-400-T	10		
46999-0018	5569-12A2S-400-T	12			46999-0520	5569-12A2G-400-T	12		
46999-0019	5569-14A2S-400-T	14			46999-0521	5569-14A2G-400-T	14		
46999-0020	5569-16A2S-400-T	16			46999-0522	5569-16A2G-400-T	16		
46999-0021	5569-18A2S-400-T	18			46999-0523	5569-18A2G-400-T	18		
46999-0022	5569-20A2S-400-T	20			46999-0524	5569-20A2G-400-T	20		
46999-0023	5569-22A2S-400-T	22			46999-0525	5569-22A2G-400-T	22		
46999-0024	5569-24A2S-400-T	24			46999-0526	5569-24A2G-400-T	24		

REVISION: M7	ECR/ECN INFORMATION: EC No: UCP2018-0918 DATE: 2014/08/29	TITLE: MINI-FIT JR.® RIGHT ANGLE HEADER ASSEMBLIES WITH MOUNTING PEGS	SHEET No. - 3 -
---------------------	--	--	------------------------

DOCUMENT NUMBER: SDA-5569-NA2*-*	Drawn By: JDFOX	Checked By: JBELL	Approved By: FSMITH
---	------------------------	--------------------------	----------------------------

TRAY PACKAGED PER PK-5569-003

PART NUMBER	ENG. NUMBER	CKT. SIZE	PLATING (NOTE 2)	HSG MAT'L	PART NUMBER	ENG. NUMBER	CKT. SIZE	PLATING (NOTE 2)	HSG MAT'L
50-36-1757	5569-02A2S-T	2	MATTE TIN OVER NICKEL SEE NOTE 2 OPTION "S"	94V-2	50-36-1758	5569-02A2S-210-T	2	MATTE TIN OVER NICKEL SEE NOTE 2 OPTION "S"	94V-0
50-36-1767	5569-04A2S-T	4			50-36-1768	5569-04A2S-210-T	4		
50-36-1777	5569-06A2S-T	6			50-36-1778	5569-06A2S-210-T	6		
50-36-1787	5569-08A2S-T	8			50-36-1788	5569-08A2S-210-T	8		
50-36-1797	5569-10A2S-T	10			50-36-1798	5569-10A2S-210-T	10		
50-36-1807	5569-12A2S-T	12			50-36-1808	5569-12A2S-210-T	12		
50-36-1817	5569-14A2S-T	14			50-36-1818	5569-14A2S-210-T	14		
50-36-1827	5569-16A2S-T	16			50-36-1828	5569-16A2S-210-T	16		
50-36-1837	5569-18A2S-T	18			50-36-1838	5569-18A2S-210-T	18		
50-36-1847	5569-20A2S-T	20			50-36-1848	5569-20A2S-210-T	20		
50-36-1857	5569-22A2S-T	22			50-36-1858	5569-22A2S-210-T	22		
50-36-1867	5569-24A2S-T	24			50-36-1868	5569-24A2S-210-T	24		

50-36-1755	5569-02A2GS-T	2	30 μ" SELECT GOLD SEE NOTE 2 OPTION "GS"	94V-2	50-36-1756	5569-02A2GS-210-T	2	30 μ" SELECT GOLD SEE NOTE 2 OPTION "GS"	94V-0
50-36-1765	5569-04A2GS-T	4			50-36-1766	5569-04A2GS-210-T	4		
50-36-1775	5569-06A2GS-T	6			50-36-1776	5569-06A2GS-210-T	6		
50-36-1785	5569-08A2GS-T	8			50-36-1786	5569-08A2GS-210-T	8		
50-36-1795	5569-10A2GS-T	10			50-36-1796	5569-10A2GS-210-T	10		
50-36-1805	5569-12A2GS-T	12			50-36-1806	5569-12A2GS-210-T	12		
50-36-1815	5569-14A2GS-T	14			50-36-1816	5569-14A2GS-210-T	14		
50-36-1825	5569-16A2GS-T	16			50-36-1826	5569-16A2GS-210-T	16		
50-36-1835	5569-18A2GS-T	18			50-36-1836	5569-18A2GS-210-T	18		
50-36-1845	5569-20A2GS-T	20			50-36-1846	5569-20A2GS-210-T	20		
39-30-1221	5569-22A2GS-T	22			50-36-1856	5569-22A2GS-210-T	22		
50-36-1865	5569-24A2GS-T	24			50-36-1866	5569-24A2GS-210-T	24		

26-01-3177	5569-02AGS3-210-T	2	50 μ" SELECT GOLD SEE NOTE 2 OPTION "GS3"	94V-0	26-01-3101	5569-02A2GS-BL-T	2	30 μ" SELECT GOLD SEE NOTE 2 OPTION "GS"	BLACK 94V-2
26-01-3178	5569-04AGS3-210-T	4			NOT TOOLED	5569-04A2GS-BL-T	4		
		6			NOT TOOLED	5569-06A2GS-BL-T	6		
		8			NOT TOOLED	5569-08A2GS-BL-T	8		
26-01-3094	5569-10AGS3-210-T	10			NOT TOOLED	5569-10A2GS-BL-T	10		
		12			NOT TOOLED	5569-12A2GS-BL-T	12		
		14			NOT TOOLED	5569-14A2GS-BL-T	14		
		16			26-01-3108	5569-16A2GS-BL-T	16		
		18			NOT TOOLED	5569-18A2GS-BL-T	18		
		20			NOT TOOLED	5569-20A2GS-BL-T	20		
		22			NOT TOOLED	5569-22A2GS-BL-T	22		
		24			NOT TOOLED	5569-24A2GS-BL-T	24		

26-01-3114	5569-02A2GS2-T	2	15 μ" SELECT GOLD SEE NOTE 2 OPTION "GS2"	94V-2						
26-01-3115	5569-04A2GS2-T	4								
26-01-3116	5569-06A2GS2-T	6								
NOT TOOLED	5569-08A2GS2-T	8								
NOT TOOLED	5569-10A2GS2-T	10								
26-01-3119	5569-12A2GS2-T	12								
NOT TOOLED	5569-14A2GS2-T	14								
NOT TOOLED	5569-16A2GS2-T	16								
NOT TOOLED	5569-18A2GS2-T	18								
NOT TOOLED	5569-20A2GS2-T	20								
NOT TOOLED	5569-22A2GS2-T	22								
26-01-3126	5569-24A2GS2-T	24								

REVISION: M7	ECR/ECN INFORMATION: EC No: UCP2018-0918 DATE: 2014/08/29	TITLE: MINI-FIT JR.® RIGHT ANGLE HEADER ASSEMBLIES WITH MOUNTING PEGS	SHEET No. - 4 -
---------------------	--	--	------------------------

DOCUMENT NUMBER: SDA-5569-NA2*-*	Drawn By: JDFOX	Checked By: JBELL	Approved By: FSMITH
---	------------------------	--------------------------	----------------------------