



Chipsmall Limited consists of a professional team with an average of over 10 year of expertise in the distribution of electronic components. Based in Hongkong, we have already established firm and mutual-benefit business relationships with customers from,Europe,America and south Asia,supplying obsolete and hard-to-find components to meet their specific needs.

With the principle of "Quality Parts,Customers Priority,Honest Operation,and Considerate Service",our business mainly focus on the distribution of electronic components. Line cards we deal with include Microchip,ALPS,ROHM,Xilinx,Pulse,ON,Everlight and Freescale. Main products comprise IC,Modules,Potentiometer,IC Socket,Relay,Connector.Our parts cover such applications as commercial,industrial, and automotives areas.

We are looking forward to setting up business relationship with you and hope to provide you with the best service and solution. Let us make a better world for our industry!



Contact us

Tel: +86-755-8981 8866 Fax: +86-755-8427 6832

Email & Skype: info@chipsmall.com Web: www.chipsmall.com





Address: A1208, Overseas Decoration Building, #122 Zhenhua RD., Futian, Shenzhen, China

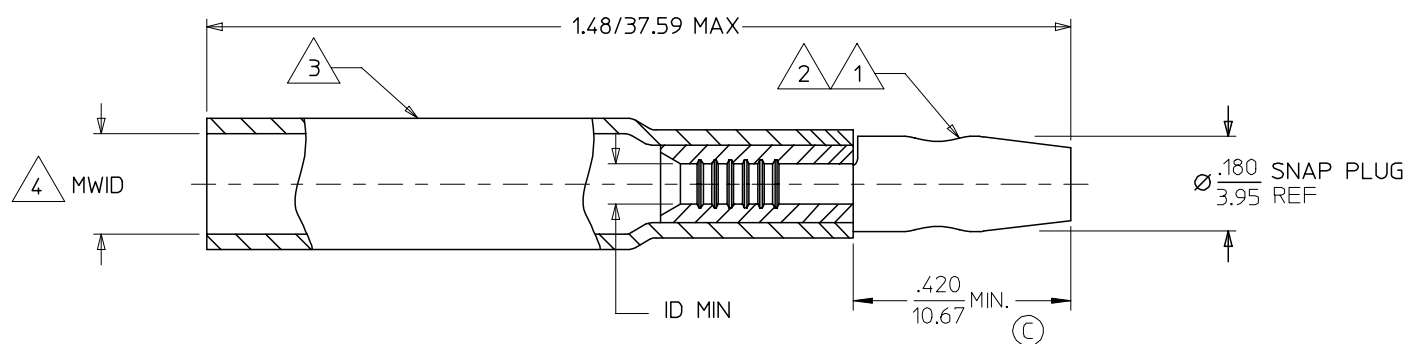





MATERIAL NUMBER	ENGINEERING NUMBER	WIRE AWG	MWID 	ID MIN	INSULATION COLOR
191640009	SA-259	22-18	.235/5.97	.054/1.35	RED
191640039	SB-279	16-14	.230/5.84	.080/2.03	BLUE



NOTE(S):

-  TERMINAL MATERIAL: COPPER ALLOY
-  FINISH: ELECTROTIN PLATE
-  INSULATION MATERIAL: HEAT SHRINKABLE TUBING WITH HOTMELT ADHESIVE INNER LINER. COLOR: SEE CHART
-  MWID: MAXIMUM WIRE INSULATION DIAMETER

SALES DRAWING

CHANGED MWID EC NO: ETC2007-0054 DRWN: JLOMASTR006/08/16 CHKD: RDEROSS 2006/08/16 APPR: JMACNEIL 2006/08/17	QUALITY SYMBOLS  0  0	GENERAL TOLERANCES (UNLESS SPECIFIED)		SCALE 1:1	DESIGN UNITS INCH	 THIRD ANGLE PROJECTION REVISE ON CAD ONLY		
				DIMENSION STYLE IN/MM			TITLE	
				4 PLACES ± --- ± ---	3 PLACES ± --- ± .010	DRAWN BY BENDERLE	DATE 2004/08/23	.180/4.57 SNAP PLUG NIAC 22-18 16-14 AWG  MOLEX INCORPORATED
				2 PLACES ± 0.25 ± .02	1 PLACE ± 0.5 ± ---	CHECKED BY R DEROSS	DATE 2004/08/23	
		ANGULAR ± 1 °		APPROVED BY RDEROSS	DATE 2004/08/23	MATERIAL NO. SEE CHART		
		DRAFT WHERE APPLICABLE MUST REMAIN WITHIN DIMENSIONS		DOCUMENT NO. SD-19164-068		SHEET NO. 1 OF 1		

THIS DRAWING CONTAINS INFORMATION THAT IS PROPRIETARY TO MOLEX INCORPORATED AND SHOULD NOT BE USED WITHOUT WRITTEN PERMISSION