



Chipsmall Limited consists of a professional team with an average of over 10 year of expertise in the distribution of electronic components. Based in Hongkong, we have already established firm and mutual-benefit business relationships with customers from,Europe,America and south Asia,supplying obsolete and hard-to-find components to meet their specific needs.

With the principle of "Quality Parts,Customers Priority,Honest Operation,and Considerate Service",our business mainly focus on the distribution of electronic components. Line cards we deal with include Microchip,ALPS,ROHM,Xilinx,Pulse,ON,Everlight and Freescale. Main products comprise IC,Modules,Potentiometer,IC Socket,Relay,Connector.Our parts cover such applications as commercial,industrial, and automotives areas.

We are looking forward to setting up business relationship with you and hope to provide you with the best service and solution. Let us make a better world for our industry!



Contact us

Tel: +86-755-8981 8866 Fax: +86-755-8427 6832

Email & Skype: info@chipsmall.com Web: www.chipsmall.com

Address: A1208, Overseas Decoration Building, #122 Zhenhua RD., Futian, Shenzhen, China



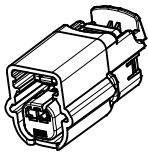

1X2

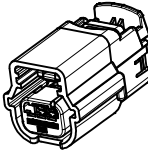

1X3

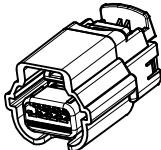

1X4

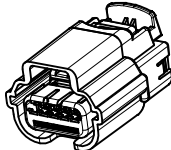

1X5

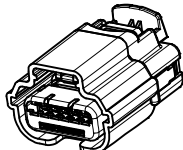

1X6

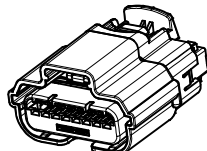

1X8

TABLE OF CONTENTS	
SHEET NO.	SHEET DESCRIPTION
1	NOTES AND BOM
2	CONNECTOR ASSEMBLY WITHOUT CLIPSLOT
3	CONNECTOR ASSEMBLY WITH CLIPSLOT
4-5	KEY CONFIGURATIONS
6-8	BOM

NOTES: VALID UNLESS OTHERWISE SPECIFIED

1. GENERAL:

- a. APPLICATION SPECIFICATION SEE: AS-31402-000
 - CONTAINS: SEE AS CONTENT
 - DESIGNED TO MATE WITH DEVICE OR CONNECTOR AS SPECIFIED IN THE MATING INTERFACE DRAWINGS CHART.
 - *DENOTES DRAWINGS THAT CAN BE ACCESSED AT <http://ewcap.uscarteams.org/>.
 - ASSEMBLY SHIPPED WITH PLR IN PRE-LOCK POSITION (SEE PLR PRE-LOCK VIEW ON SHEET 2 SECTION A-A).
- b. PRODUCT RELATED DRAWING REFER TO DRAWING INFORMATION CHART
- c. TPA'S MAY BECOME SEATED DURING TRANSIT, IF THIS OCCURS, TPA'S SHOULD BE MOVED TO THE PRE-LOCKED POSITION PRIOR TO FEMALE TERMINAL INSTALLATION. REFERENCE PRODUCT SPECIFICATION: PS-34646-001
- d. PARTS MUST BE IN COMPLIANCE TO MOLEX CHEMICAL SUBSTANCES FOR PRODUCTS AND PACKAGING SPECIFICATION: QEH5-699000-301
- e. DATA MUST BE SUBMITTED UNDER THE MOLEX PART NUMBER TO IMDS (COMPANY ID#13255)
- f. SYSTEM EXCEPT SERIES 31404 1X8 CIRCUIT TO BE USED WITH OUTSIDE WIRE DIAMETERS RANGING FROM 1.20MM TO 2.06MM WITHIN RANGE OF:
 - SAE 22 AWG TO 18 AWG PER ESB-MIL123-A2
 - ISO 0.35MM² TO 0.75MM² PER GMW15626 AND ES-AU5T-1A348-AA
- g. POLARIZATION FEATURE EFFECTIVENESS PER USCAR-2 PARAGRAPH 5.4.4 IS REDUCED WHEN TESTING ALL POLARIZATION OPTIONS: 100N MIN.
- h. SEE SHEET #3 FOR CONNECTOR ASSEMBLY WITH CLIPSLOT
- i. FOR CLIPSLOT CONNECTOR: CLIP OVERHANGS CONNECTOR, PLEASE CHECK APPLICATION (COULD CAUSE WIRE CHAFING)-SHORTER CLIP IS A RECOMMENDATION.

2. DESIGN - GEOMETRY:

- a. THE 3-D CAD DATA IS BASIC (WITHOUT TOLERANCE) AND MASTER FOR THIS PART WITH THE EXCEPTION OF UNDERLINED DIMENSIONS. DIMENSIONAL INFORMATION NOT SHOWN ON THIS DRAWING IS DEFINED BY THE DATA FILE AT ITS LATEST REVISION.
- b. GEOMETRIC DIMENSIONS AND TOLERANCES PER ASME Y14.5M-2009
- c. EDGES AND UNDIMENSIONED DETAILS PER ISO13715
- d. CORNERS SHOWN AS SHARP TO BE R 0.2 MAX.
- e. LETTERING SHALL BE 0.15 MAX RAISED IN 0.25 MAX RECESS PAD. THIS INCLUDES RECYCLING CODE, CAVITY ID, VENDOR IDENTIFICATION, AND CUSTOMER MATERIAL NUMBER.
- f. VISUAL DEFECTS SHALL MEET COSMETIC STANDARD PS-45499-002 (Class B).
- g. DATE CODE: FIRST TWO DIGITS ARE THE CALENDAR YEAR (EXAMPLE: 04 = 2004). THIRD THROUGH 5TH DIGIT DAY # OF THE CALENDAR YEAR (EXAMPLE: FEB. 3RD = '034').

DRAWING INFORMATION

DESCRIPTION	DRAWING NO.
PRODUCT SPECIFICATION	PS-31402-000 FOR 31404 1X8 REFER TO PS-31404-001-1X8
PACKAGING	PK-31300-256
SALES DRAWING	SD-31402-211 FOR 31404 1X8 REFER TO SD-31404-811
TEST SUMMARY	FOR 1X2 REFER TO TS-31402-001-1X2
	FOR 1X3 REFER TO TS-31402-001-1X3
	FOR 1X6 REFER TO TS-31402-001-1X6
	FOR 31404 1X8 REFER TO TS-31404-001-1X8

MATING INTERFACE DRAWING

DESCRIPTION	INTERFACE DEFINITION
1X2	*064-S-002-1-Z02
1X3	*064-S-003-1-Z01
1X4	*064-S-004-1-Z02
1X5	*064-S-005-1-Z02
1X6	*064-S-006-1-Z02
1X8	*064-S-008-1-Z02

PART NUMBER LEGEND
CONNECTOR ASSEMBLY

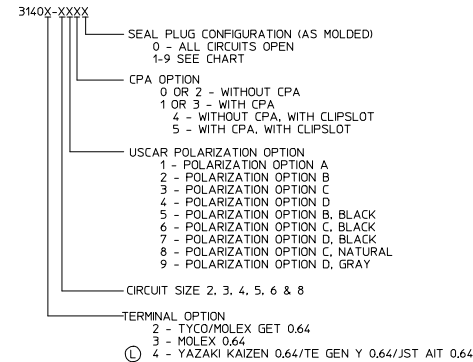

S	ADD P/N: 31402-6131, 31402-6121
R	ADD P/N: 31404-3112, 31404-3102
P	ADD P/N: 31403-3132; 31403-3122
M	ADD P/N: 31402-6118, 31402-6108
L	1. REDRAW SALES DRAWING 2. UPDATE TERMINAL INFORMATION FOR 31404 SERIES 3. ADD P/N: 31403-6212; 31403-6202
REV	REV DESCRIPTION

ADD NEW P/N EC NO: UAU2017-0615 DRAWN BY: CHKD: APPR: IDEN602 2017/01/19 2017/01/23	QUALITY SYMBOLS	GENERAL TOLERANCES (UNLESS SPECIFIED)	DIMENSION STYLE	SCALE	DESIGN UNITS	THIRD ANGLE PROJECTION
	∇=0 ∇=0 ∇=0	mm INCH	4 PLACES ± --- ± --- 3 PLACES ± --- ± --- 2 PLACES ± 0.13 ± --- 1 PLACE ± 0.3 ± --- 0 PLACE ± ±	MM ONLY DRAWN BY: R CARLSON CHECKED BY: R CARLSON APPROVED BY: VKOSHY DATE: 2003/09/25 DATE: 2004/09/28 DATE: 2010/11/22	4:1	METRIC
MATERIAL NO. SEE CHART DRAFT WHERE APPLICABLE MUST REMAIN WITHIN DIMENSIONS			MATERIAL NO. SEE CHART SIZE D		TITLE: 0.64 USCAR CONNECTOR SEALED SINGLE ROW ASSEMBLY molex DOCUMENT NO. SD-31402-211 SHEET NO. 1 OF 8	
THIS DRAWING CONTAINS INFORMATION THAT IS PROPRIETARY TO MOLEX						

CONNECTOR ASSEMBLY WITHOUT CLIPSLOT

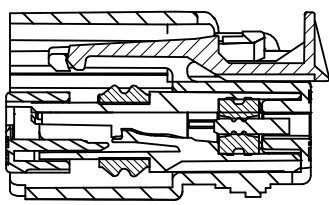

SECTION A-A
TPA SHOWN IN AS-SHIPED
PRE-LOCKED POSITION
SEE NOTE 1c

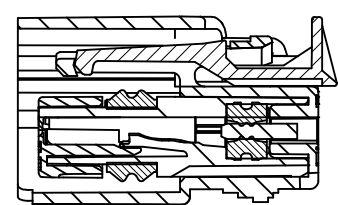

SECTION A-A
TPA SHOWN IN FINAL
LOCKED POSITION

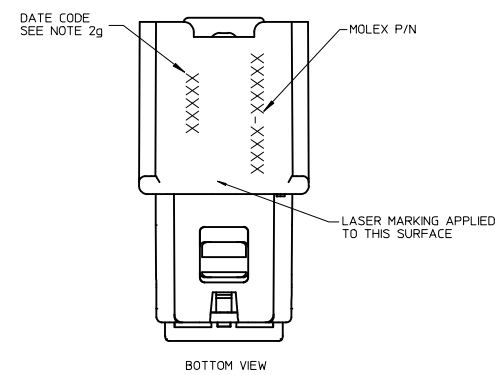

BOTTOM VIEW

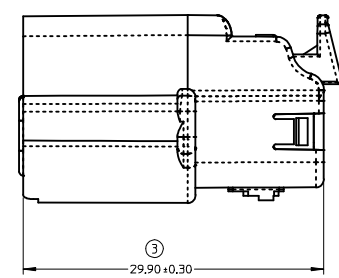
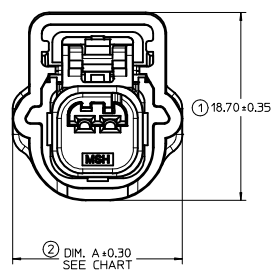
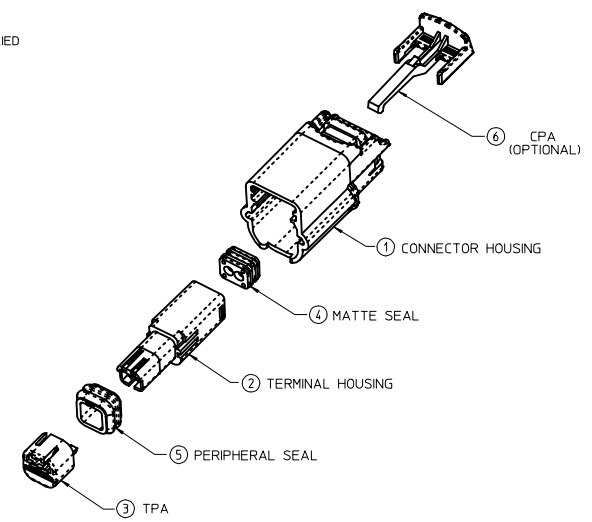

RIGHT SIDE VIEW

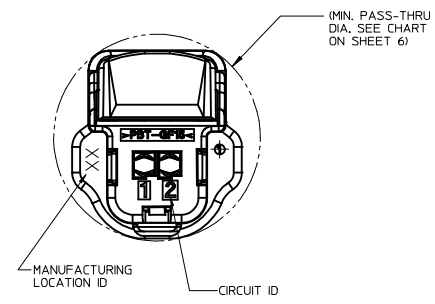

BACK VIEW

ITEM	DESCRIPTION	COLOR	MATERIAL
1	CONNECTOR HOUSING	SEE CHART	PBT GF15
2	TERMINAL HOUSING	BLACK	SPS/PA66 GF30
3	TPA	NATURAL	SPS/PA66 GF20
4	MATTE SEAL	SEE CHART	SILICONE RUBBER
5	PERIPHERAL SEAL	SEE CHART	SILICONE RUBBER
6	CPA - OPTIONAL	RED	PBT GF30

ADD NEW P/N EC NO: UAU2017-0615 DRAWN BY: UJDRWNTYE CHKD: APPR: IDENGOZ 2017/01/19 2017/01/23	QUALITY SYMBOLS ▽=0 ▽=0 ▽=0	GENERAL TOLERANCES (UNLESS SPECIFIED) mm INCH 4 PLACES ± --- ± --- 3 PLACES ± --- ± --- 2 PLACES ± 0.13 ± --- 1 PLACE ± 0.3 ± --- 0 PLACE ± ±	DIMENSION STYLE MM ONLY	SCALE 4:1	DESIGN UNITS METRIC	THIRD ANGLE PROJECTION
	DRAWN BY: RCARLSON CHECKED BY: RCARLSON APPROVED BY: VKOSHY	DATE: 2003/09/25 DATE: 2004/09/28 DATE: 2010/11/22	MATERIAL NO. SEE CHART	DOCUMENT NO. SD-31402-211	TITLE 0.64 USCAR CONNECTOR SEALED SINGLE ROW ASSEMBLY	SHEET NO. 2 OF 8
	DRAFT WHERE APPLICABLE MUST REMAIN WITHIN DIMENSIONS					
	THIS DRAWING CONTAINS INFORMATION THAT IS PROPRIETARY TO MOLEX INCORPORATED AND SHOULD NOT BE USED WITHOUT WRITTEN PERMISSION					

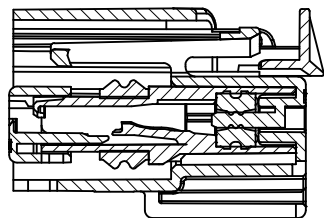

SECTION C-C
TPA SHOWN IN AS-SHIPED
PRE-LOCKED POSITION
SEE NOTE 1c

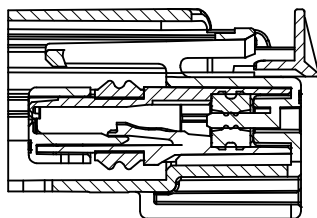

SECTION C-C
TPA SHOWN IN FINAL
LOCKED POSITION

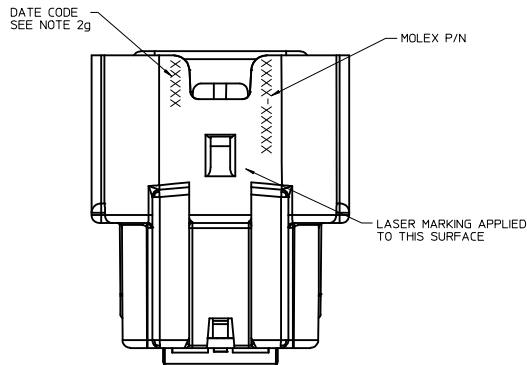

BOTTOM VIEW

CONNECTOR ASSEMBLY WITH CLIPSLOT

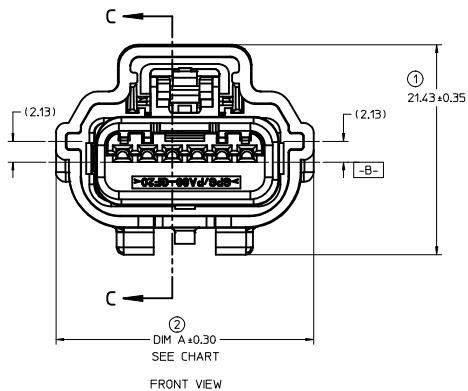
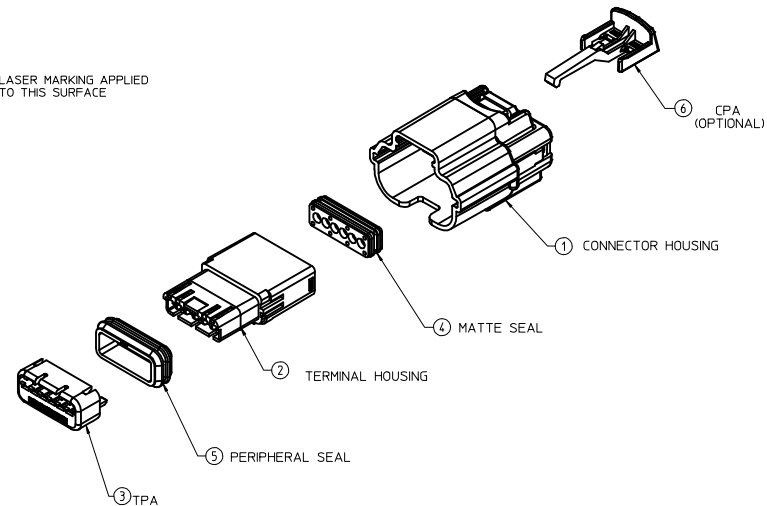

POLARIZATION A

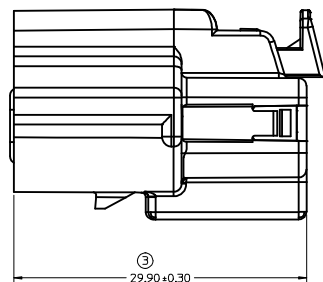

RIGHT SIDE VIEW

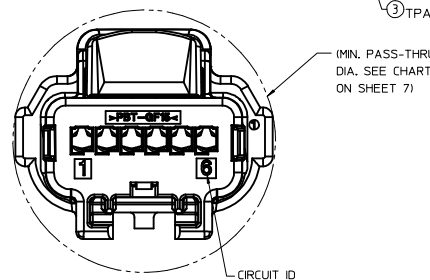

BACK VIEW

ITEM	DESCRIPTION	COLOR	MATERIAL
1	CONNECTOR HOUSING	SEE CHART	PBT GF15
2	TERMINAL HOUSING	BLACK	SPS/PA66 GF30
3	TPA	NATURAL	SPS/PA66 GF20
4	MATTE SEAL	SEE CHART	SILICONE RUBBER
5	PERIPHERAL SEAL	SEE CHART	SILICONE RUBBER
6	CPA - OPTIONAL	RED	PBT GF30

ADD NEW P/N EC NO: UAU2017-0615 DRAWN BY: 2017/01/19 CHKD: 2017/01/19 APPR: JENGG02 2017/01/23 REV: DESCRIPTION	QUALITY SYMBOLS ∇=0 ∇=0 ∇=0	GENERAL TOLERANCES (UNLESS SPECIFIED) mm INCH 4 PLACES ± --- ± --- 3 PLACES ± 0.13 ± --- 2 PLACES ± 0.3 ± --- 1 PLACE ± 0.3 ± --- 0 PLACE ± ±	DIMENSION STYLE MM ONLY DRAWN BY: DATE R CARLSON 2003/09/25 CHECKED BY: DATE R CARLSON 2004/09/28 APPROVED BY: DATE VKOSHY 2010/11/22	SCALE 4:1 DESIGN UNITS METRIC THIRD ANGLE PROJECTION	TITLE 0.64 USCAR CONNECTOR SEALED SINGLE ROW ASSEMBLY molex	MATERIAL NO. SEE CHART DOCUMENT NO. SD-31402-211	SHEET NO. 3 OF 8
	ANGULAR ± 3 ° DRAFT WHERE APPLICABLE MUST REMAIN WITHIN DIMENSIONS		THIS DRAWING CONTAINS INFORMATION THAT IS PROPRIETARY TO MOLEX INCORPORATED AND SHOULD NOT BE USED WITHOUT WRITTEN PERMISSION				

1X2

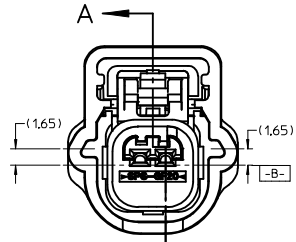

FRONT VIEW
POLARIZATION A

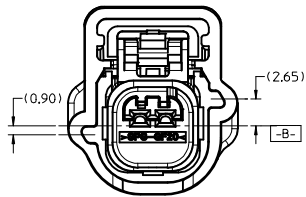

POLARIZATION B

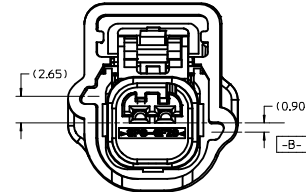

POLARIZATION C

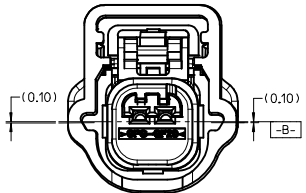

POLARIZATION D

1X3

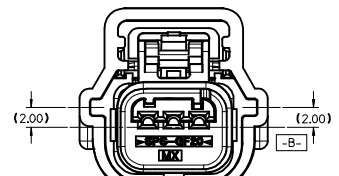

POLARIZATION A

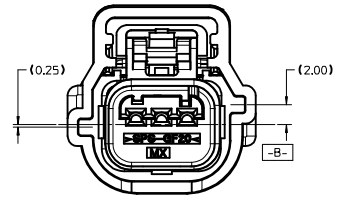

POLARIZATION B

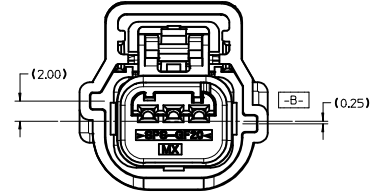

POLARIZATION C

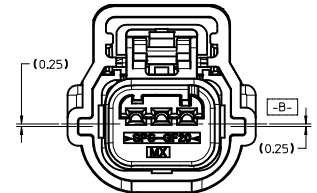

POLARIZATION D

1X4

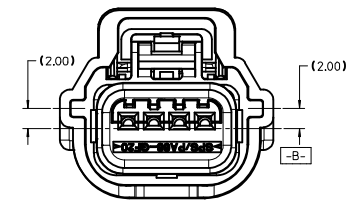

POLARIZATION A

KEY CONFIGURATIONS

ADD NEW P/N
EC NO: UAU2017-0615
DRAWN BY: CHYK
CHKD: APPR: JDEMOZ
2017/01/19
2017/01/23

REV	DESCRIPTION
▽=0	
▽=1	
▽=2	
▽=3	

QUALITY SYMBOLS		GENERAL TOLERANCES (UNLESS SPECIFIED)	
mm	INCH	mm	INCH
4 PLACES ±	---	±	---
3 PLACES ±	---	±	---
2 PLACES ±	0.13	±	---
1 PLACE ±	0.3	±	---
0 PLACE ±		±	

DIMENSION STYLE		SCALE		DESIGN UNITS		THIRD ANGLE PROJECTION	
MM ONLY		4:1		METRIC		THIRD ANGLE PROJECTION	
DRAWN BY	DATE	TITLE		0.64 USCAR CONNECTOR SEALED SINGLE ROW ASSEMBLY			
RCARLSON	2003/09/25			molex			
CHECKED BY	DATE						
RCARLSON	2004/09/28			DOCUMENT NO. SD-31402-211			
APPROVED BY	DATE			SHEET NO. 4 OF 8			
VKOSHY	2010/11/22						

MATERIAL NO. SEE CHART
 SIZE 1
 THIS DRAWING CONTAINS INFORMATION THAT IS PROPRIETARY TO MOLEX INCORPORATED AND SHOULD NOT BE USED WITHOUT WRITTEN PERMISSION

1X5

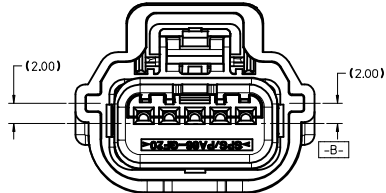

POLARIZATION A

1X6

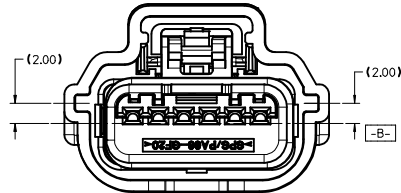

POLARIZATION A

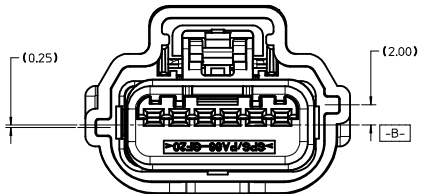

POLARIZATION B

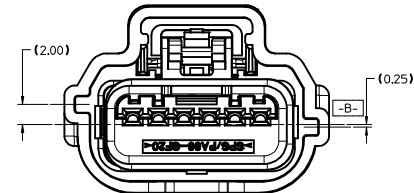

POLARIZATION C

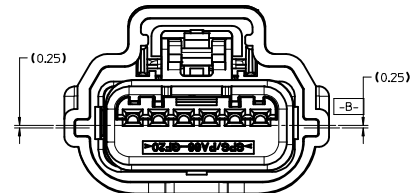

POLARIZATION D

1X8

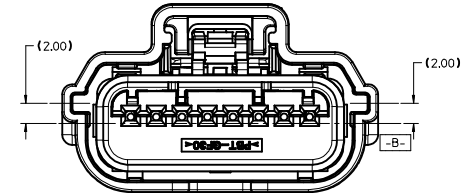

POLARIZATION A

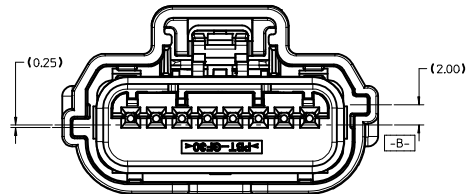

POLARIZATION B

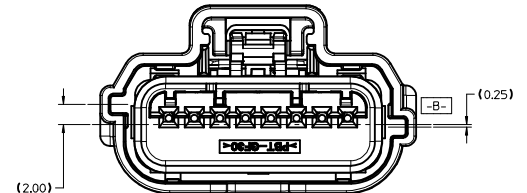

POLARIZATION C

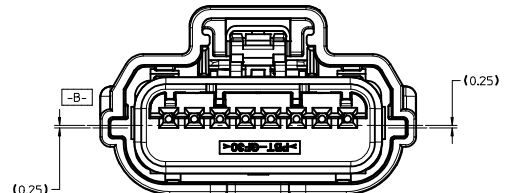

POLARIZATION D

KEY CONFIGURATIONS

ADD NEW P/N EC NO: UAU2017-0615 DRAWN BY: 2017/01/19 CHKD: APPR: JDENG02 2017/01/23	QUALITY SYMBOLS ▽=0 ▽=0 ▽=0	GENERAL TOLERANCES (UNLESS SPECIFIED)		DIMENSION STYLE MM ONLY		SCALE 4:1	DESIGN UNITS METRIC	THIRD ANGLE PROJECTION
		mm	INCH	DRAWN BY RCARLSON	DATE 2003/09/25	TITLE 0.64 USCAR CONNECTOR SEALED SINGLE ROW ASSEMBLY	DOCUMENT NO. SD-31402-211	SHEET NO. 5 OF 8
		4 PLACES ±	±	CHECKED BY RCARLSON	DATE 2004/09/28	THIS DRAWING CONTAINS INFORMATION THAT IS PROPRIETARY TO MOLEX INCORPORATED AND SHOULD NOT BE USED WITHOUT WRITTEN PERMISSION		
		3 PLACES ±	±	APPROVED BY VKOSHY	DATE 2010/11/22			
		2 PLACES ±	±0.13	MATERIAL NO. SEE CHART				
		1 PLACE ±	±0.3	DRAFT WHERE APPLICABLE MUST REMAIN WITHIN DIMENSIONS				
		0 PLACE ±	±	ANGULAR ± 3°				

PART NUMBER WITHOUT CPA	PART NUMBER WITH CPA	CLIPSLOT OPTION	ROW/ CIRCUITS	KEY*	MATTE SEAL COLOR	PERIMETER SEAL COLOR	CONNECTOR COLOR	WIDTH DIM (A)	MIN. PASS THRU DIA.	FEMALE TERMINAL SUPPLIER	USCAR FOOTPRINT DRAWING NO.	STATUS	
31402-2100	31402-2110	NO	1 X 2	A	ROYAL BLUE	BLUE	BLACK	16.88	(20.80)	TYCO OR MOLEX GET 0.64	064-S-002-1-Z02	TOOLED	
31402-2200	31402-2210			B			GRAY					TOOLED	
31402-2300	31402-2310			C			BROWN					TOOLED, COLOR UNAVAILABLE	
31402-2400	31402-2410			D			GREEN					TOOLED, COLOR UNAVAILABLE	
31402-2500	31402-2510			B			BLACK					TOOLED	
31402-2600	31402-2610			C			BLACK					TOOLED	
31402-2700	31402-2710			D			BLACK					TOOLED	
31403-2000	31403-2010			D			DK. GRAY					TOOLED	
31403-2100	31403-2110			A			BLACK					TOOLED	
31403-2200	31403-2210			B			GRAY					TOOLED	
31403-2300	31403-2310			C			BROWN					TOOLED, COLOR UNAVAILABLE	
31403-2400	31403-2410			D			GREEN					TOOLED, COLOR UNAVAILABLE	
31403-2500	31403-2510			D			BLACK					TOOLED	
31403-2600	31403-2610			C			BLACK					TOOLED	
31403-2700	31403-2710			D			BLACK					TOOLED	
31403-2800	31403-2810			C			NATURAL					TOOLED	
31403-2900	31403-2910			D			GRAY					TOOLED	
31404-2100	31404-2110			A			BLACK					NOT TOOLED	
31404-2200	31404-2210		B	GRAY	NOT TOOLED								
31404-2300	31404-2310		C	BROWN	NOT TOOLED								
31404-2400	31404-2410		D	GREEN	NOT TOOLED								
31404-2500	31404-2510		B	BLACK	NOT TOOLED								
31404-2600	31404-2610		C	BLACK	NOT TOOLED								
31404-2700	31404-2710		D	BLACK	NOT TOOLED								
31402-3100	31402-3110		NO	1 X 3	A	LIGHT BLUE	RUST RED	BLACK	18.70	(22.00)	TYCO OR MOLEX GET 0.64	064-S-003-1-Z01	TOOLED
31402-3200	31402-3210				B			GRAY					TOOLED
31402-3300	31402-3310				C			BROWN					TOOLED, COLOR UNAVAILABLE
31402-3400	31402-3410				D			GREEN					TOOLED, COLOR UNAVAILABLE
31402-3500	31402-3510				B			BLACK					TOOLED
31402-3600	31402-3610				C			BLACK					TOOLED
31402-3700	31402-3710				D			BLACK					TOOLED
31403-3000	31403-3010				D			DK. GRAY					TOOLED
31403-3100	31403-3110				A			BLACK					TOOLED
31403-3200	31403-3210				B			GRAY					TOOLED
31403-3300	31403-3310				C			BROWN					TOOLED, COLOR UNAVAILABLE
31403-3400	31403-3410				D			GREEN					TOOLED, COLOR UNAVAILABLE
31403-3500	31403-3510	B			BLACK			TOOLED					
31403-3600	31403-3610	C			BLACK			TOOLED					
31403-3700	31403-3710	D			BLACK			TOOLED					
31403-3800	31403-3810	C			NATURAL			TOOLED					
31404-3100	31404-3110	A			BLACK			TOOLED					
31404-3200	31404-3210	B			GRAY			TOOLED					
31404-3300	31404-3310	C		BROWN	TOOLED, COLOR UNAVAILABLE								
31404-3400	31404-3410	D		GREEN	TOOLED, COLOR UNAVAILABLE								
31404-3500	31404-3510	B		BLACK	TOOLED								
31404-3600	31404-3610	C		BLACK	TOOLED								
31404-3700	31404-3710	D		BLACK	TOOLED								
31402-4100	31402-4110	NO		1 X 4	A	TBD	TBD	BLACK	21.25	(22.34)	TYCO OR MOLEX GET 0.64	064-S-004-1-Z02	NOT TOOLED
31402-4200	31402-4210				B			GRAY					NOT TOOLED
31402-4300	31402-4310				C			BROWN					NOT TOOLED
31402-4400	31402-4410				D			GREEN					NOT TOOLED
31402-4500	31402-4510				B			BLACK					NOT TOOLED
31402-4600	31402-4610				C			BLACK					NOT TOOLED
31402-4700	31402-4710				D			BLACK					NOT TOOLED
31403-4100	31403-4110				A			BLACK					NOT TOOLED
31403-4200	31403-4210				B			GRAY					NOT TOOLED
31403-4300	31403-4310				C			BROWN					NOT TOOLED
31403-4400	31403-4410				D			GREEN					NOT TOOLED
31403-4500	31403-4510				B			BLACK					NOT TOOLED
31403-4600	31403-4610				C			BLACK					NOT TOOLED
31403-4700	31403-4710		D		BLACK			NOT TOOLED					
31404-4100	31404-4110		A		BLACK			NOT TOOLED					
31404-4200	31404-4210		B		GRAY			NOT TOOLED					
31404-4300	31404-4310		C		BROWN			NOT TOOLED					
31404-4400	31404-4410		D		GREEN			NOT TOOLED					
31404-4500	31404-4510	B	BLACK	NOT TOOLED									
31404-4600	31404-4610	C	BLACK	NOT TOOLED									
31404-4700	31404-4710	D	BLACK	NOT TOOLED									

ADD NEW P/N EC NO. UAU2017-0615 2017/01/19 DRAWN BY: CHYK CHKD: APPR: JDENG02 2017/01/23 REV DESCRIPTION	QUALITY SYMBOLS	GENERAL TOLERANCES (UNLESS SPECIFIED)	DIMENSION STYLE	SCALE	DESIGN UNITS	THIRD ANGLE PROJECTION
	▽=0	4 PLACES ± 0.13	MM ONLY	4:1	METRIC	0.64 USCAR CONNECTOR SEALED SINGLE ROW ASSEMBLY
	▽=0	3 PLACES ± 0.13				molex
	▽=0	2 PLACES ± 0.3				SD-31402-211
		ANGULAR ± 3°	DRAWN BY DATE			SHEET NO.
		DRAFT WHERE APPLICABLE MUST REMAIN WITHIN DIMENSIONS	RCARLSON 2003/09/25			6 OF 8
			CHECKED BY DATE			
			RCARLSON 2004/09/28			
			APPROVED BY DATE			
			VKOSHY 2010/11/22			
			MATERIAL NO.	DOCUMENT NO.		
			SEE CHART			

PART NUMBER WITHOUT CPA	PART NUMBER WITH CPA	CLIPSLOT OPTION	ROW/ CIRCUITS	KEY*	MATTE SEAL COLOR	PERIMETER SEAL COLOR	CONNECTOR COLOR	WIDTH DIM (A)	MIN. PASS THRU DIA.	FEMALE TERMINAL SUPPLIER	USCAR FOOTPRINT DRAWING NO.	STATUS
31402-5100	31402-5110	NO	1 X 5	A	TBD	TBD	BLACK	23.80	(24.28)	TYCO OR MOLEX GET 0.64	064-S-005-1-202	NOT TOOLED
31402-5200	31402-5210			B			GRAY					NOT TOOLED
31402-5300	31402-5310			C			BROWN					NOT TOOLED
31402-5400	31402-5410			D			GREEN					NOT TOOLED
31402-5500	31402-5510			B			BLACK					NOT TOOLED
31402-5600	31402-5610			C			BLACK					NOT TOOLED
31402-5700	31402-5710			D			BLACK					NOT TOOLED
31403-5100	31403-5110			A			BLACK					NOT TOOLED
31403-5200	31403-5210			B			GRAY					NOT TOOLED
31403-5300	31403-5310			C			BROWN					NOT TOOLED
31403-5400	31403-5410			D			GREEN			NOT TOOLED		
31403-5500	31403-5510			B			BLACK			NOT TOOLED		
31403-5600	31403-5610			C			BLACK			NOT TOOLED		
31403-5700	31403-5710			D			BLACK			NOT TOOLED		
31404-5100	31404-5110			A			BLACK			NOT TOOLED		
31404-5200	31404-5210			B			GRAY			NOT TOOLED		
31404-5300	31404-5310			C			BROWN			NOT TOOLED		
31404-5400	31404-5410			D			GREEN			NOT TOOLED		
31404-5500	31404-5510			B			BLACK			NOT TOOLED		
31404-5600	31404-5610			C			BLACK			NOT TOOLED		
31404-5700	31404-5710	D	BLACK	NOT TOOLED								
31402-6100	31402-6110	NO	1 X 6	A	ROYAL BLUE	LIGHT BLUE	BLACK	26.33	(26.82)	TYCO OR MOLEX GET 0.64	064-S-006-1-202	TOOLED
31402-6200	31402-6210			B			GRAY					TOOLED, COLOR UNAVAILABLE
31402-6300	31402-6310			C			BROWN					TOOLED, COLOR UNAVAILABLE
31402-6400	31402-6410			D			GREEN					TOOLED
31402-6500	31402-6510			B			BLACK					TOOLED
31402-6600	31402-6610			C			BLACK					TOOLED
31402-6700	31402-6710			D			BLACK					TOOLED
31403-6100	31403-6110			A			BLACK					TOOLED
31403-6200	31403-6210			B			GRAY					TOOLED
31403-6300	31403-6310			C			BROWN					TOOLED, COLOR UNAVAILABLE
31403-6400	31403-6410			D			GREEN			TOOLED, COLOR UNAVAILABLE		
31403-6500	31403-6510			B			BLACK			TOOLED		
31403-6600	31403-6610			C			BLACK			TOOLED		
31403-6700	31403-6710			D			BLACK			TOOLED		
31404-6100	31404-6110			A			BLACK			TOOLED		
31404-6200	31404-6210			B			GRAY			TOOLED		
31404-6300	31404-6310			C			BROWN			TOOLED, COLOR UNAVAILABLE		
31404-6400	31404-6410			D			GREEN			TOOLED, COLOR UNAVAILABLE		
31404-6500	31404-6510			B			BLACK			TOOLED		
31404-6600	31404-6610			C			BLACK			TOOLED		
31404-6700	31404-6710	D	BLACK	TOOLED								
31404-6800	31404-6810	C	NATURAL	TOOLED								

ADD NEW P/N EC NO. UAU2017-0615 DRAWN BY CHKD: APPR.: JENGOZ 2017/01/13 REV DESCRIPTION	QUALITY SYMBOLS ▽=0 ▽=0 ▽=0		GENERAL TOLERANCES (UNLESS SPECIFIED) mm INCH 4 PLACES ± --- ± --- 3 PLACES ± --- ± --- 2 PLACES ± 0.13 ± --- 1 PLACE ± 0.3 ± --- 0 PLACE ± ±		DIMENSION STYLE MM ONLY DRAWN BY DATE RCARLSON 2003/09/25 CHECKED BY DATE RCARLSON 2004/09/28 APPROVED BY DATE VKOSHY 2010/11/22		SCALE 4:1 DESIGN UNITS METRIC THIRD ANGLE PROJECTION		TITLE 0.64 USCAR CONNECTOR SEALED SINGLE ROW ASSEMBLY molex		MATERIAL NO. SEE CHART DOCUMENT NO. SD-31402-211		SHEET NO. 7 OF 8	
	ANGULAR ± 3 ° DRAFT WHERE APPLICABLE MUST REMAIN WITHIN DIMENSIONS			THIS DRAWING CONTAINS INFORMATION THAT IS PROPRIETARY TO MOLEX INCORPORATED AND SHOULD NOT BE USED WITHOUT WRITTEN PERMISSION										

PART NUMBER WITHOUT CPA	PART NUMBER WITH CPA	CLIPSLOT OPTION	ROW/CIRCUITS	KEY	MATE SEAL COLOR	PERMETER SEAL COLOR	CONNECTOR COLOR	WIDTH (A)	MIN. PASS THRU DIA.	FEMALE TERMINAL SUPPLIER	USCAR FOOTPRINT DRAWING NO.	STATUS
31402-8100	31402-8110	NO	1 X 8	A	TBD	TBD	BLACK	31.25	(31.90)	TYCO OR MOLEX GET 0.64	064-S-008-1-Z02	NOT TOOLED
31402-8200	31402-8210			B			GRAY					NOT TOOLED
31402-8300	31402-8310			C			BROWN					NOT TOOLED
31402-8400	31402-8410			D			GREEN					NOT TOOLED
31402-8500	31402-8510			B			BLACK					NOT TOOLED
31402-8600	31402-8610			C			BLACK					NOT TOOLED
31402-8700	31402-8710			D			BLACK					NOT TOOLED
31403-8100	31403-8110			A			BLACK					NOT TOOLED
31403-8200	31403-8210			B			GRAY					NOT TOOLED
31403-8300	31403-8310			C			BROWN					NOT TOOLED
31403-8400	31403-8410			D			GREEN			NOT TOOLED		
31403-8500	31403-8510			B			BLACK			NOT TOOLED		
31403-8600	31403-8610			C			BLACK			NOT TOOLED		
31403-8700	31403-8710			D			BLACK			NOT TOOLED		
31404-8100	31404-8110			A			BLACK			NOT TOOLED		
31404-8200	31404-8210			B			LT. GRAY			INFORMATION REFER TO		
31404-8300	31404-8310			C			DK. GRAY			SD-31404-811		
31404-8400	31404-8410			D			TBD					

ADDITIONAL CAVITY PLUG CONFIGURATIONS:

ROW/CIRCUITS	FEMALE TERMINAL	MOLEX P/N WITH CPA	MOLEX P/N WITHOUT CPA	KEY OPTION	CLIPSLOT OPTION	COLOR	CIRCUIT NUMBER: "0" INDICATED PLUG LOCATION						TOTAL CIRCUITS PLUGGED	STATUS	
							1	2	3	4	5	6			
1X6	TYCO/MOLEX GET	31402-6110	31402-6100	A	NO	BLACK							0	TOOLED	
		31402-6111	31402-6101	A	NO	BLACK	0	0	0	0	0	0	6	TOOLED	
		31402-6112	31402-6102	A	NO	BLACK	0	0					2	TOOLED	
		31402-6113	31402-6103	A	NO	BLACK	0	0					1	TOOLED	
		31402-6114	31402-6104	A	NO	BLACK	0	0	0	0			4	TOOLED	
		31402-6115	31402-6105	A	NO	BLACK			0		0	0	3	TOOLED	
		31402-6118	31402-6108	A	NO	BLACK					0		1	TOOLED	
		31402-6119	31402-6109	A	NO	BLACK			0				1	TOOLED	
		31402-6131	31402-6121	A	NO	BLACK				0			1	TOOLED	
		31402-6150	31402-6140	A	YES	BLACK							0	TOOLED	
	MOLEX 0.64	31403-6110	31403-6100	A	NO	BLACK							0	TOOLED	
		31403-6111	31403-6101	A	NO	BLACK	0	0	0	0	0	0	6	TOOLED	
		31403-6112	31403-6102	A	NO	BLACK	0	0					1	TOOLED	
		31403-6113	31403-6103	A	NO	BLACK	0	0	0		0		4	TOOLED	
		31403-6114	31403-6104	A	NO	BLACK	0	0			0	0	2	TOOLED	
		31403-6212	31403-6202	B	NO	GRAY				0	0	0	3	TOOLED	
		YAZAKI KAIZEN 0.64 TE GEN Y 0.64 JST AIT 0.64	31404-6110	31404-6100	A	NO	BLACK							0	TOOLED
			31404-6111	31404-6101	A	NO	BLACK	0	0	0	0	0	0	6	TOOLED
			31404-6112	31404-6102	A	NO	BLACK	0	0					2	TOOLED
			31404-6113	31404-6103	A	NO	BLACK	0	0				0	2	TOOLED
31404-6116	31404-6106		A	NO	BLACK						0	1	TOOLED		
31404-6117	31404-6107		A	NO	BLACK	0	0			0	0	3	TOOLED		
31404-6118	31404-6108		A	NO	BLACK	0						1	TOOLED		
31404-6119	31404-6109		A	NO	BLACK			0		0	0	3	TOOLED		
31404-6132	31404-6122		A	NO	BLACK			0				1	TOOLED		
31404-6213	31404-6203		B	NO	GRAY	0					0	2	TOOLED		
1X3	YAZAKI KAIZEN 0.64 TE GEN Y 0.64 JST AIT 0.64	31404-6214	31404-6204	B	NO	GRAY				0	0	1	TOOLED		
		31404-6812	31404-6802	C	NO	NATURAL				0	0	3	TOOLED		
		31402-3113	31402-3103	A	NO	BLACK			0				1	TOOLED	
		31403-3132	31403-3122	A	NO	GRAY			0				1	TOOLED	
		31404-3112	31404-3102	A	NO	BLACK			0			1	OK TO TOOL		

ADD NEW P/N EC NO. UAU2017-0615 DRAWN BY CHKO: APPR: JENGG02 2017/01/19 2017/01/23 DESCRIPTION	QUALITY SYMBOLS	GENERAL TOLERANCES (UNLESS SPECIFIED)	DIMENSION STYLE	SCALE	DESIGN UNITS	THIRD ANGLE PROJECTION	
	∇=0 ∇=0 ∇=0	4 PLACES ± 0.15 3 PLACES ± 0.13 1 PLACE ± 0.3 0 PLACE ±	mm INCH ± 0.15 ± 0.005 ± 0.13 ± 0.005 ± 0.3 ± 0.015 ±	MM ONLY	4:1	METRIC	DRAWN BY DATE RCARLSON 2003/09/25 CHECKED BY DATE RCARLSON 2004/09/28 APPROVED BY DATE VKOSHY 2010/11/22
	ANGULAR ± 3 ° DRAFT WHERE APPLICABLE MUST REMAIN WITHIN DIMENSIONS		MATERIAL NO. SEE CHART	TITLE 0.64 USCAR CONNECTOR SEALED SINGLE ROW ASSEMBLY	DOCUMENT NO. SD-31402-211	SHEET NO. 8 OF 8	
	THIS DRAWING CONTAINS INFORMATION THAT IS PROPRIETARY TO MOLEX INCORPORATED AND SHOULD NOT BE USED WITHOUT WRITTEN PERMISSION						