



Chipsmall Limited consists of a professional team with an average of over 10 year of expertise in the distribution of electronic components. Based in Hongkong, we have already established firm and mutual-benefit business relationships with customers from,Europe,America and south Asia,supplying obsolete and hard-to-find components to meet their specific needs.

With the principle of "Quality Parts,Customers Priority,Honest Operation,and Considerate Service",our business mainly focus on the distribution of electronic components. Line cards we deal with include Microchip,ALPS,ROHM,Xilinx,Pulse,ON,Everlight and Freescale. Main products comprise IC,Modules,Potentiometer,IC Socket,Relay,Connector.Our parts cover such applications as commercial,industrial, and automotives areas.

We are looking forward to setting up business relationship with you and hope to provide you with the best service and solution. Let us make a better world for our industry!



Contact us

Tel: +86-755-8981 8866 Fax: +86-755-8427 6832

Email & Skype: info@chipsmall.com Web: www.chipsmall.com

Address: A1208, Overseas Decoration Building, #122 Zhenhua RD., Futian, Shenzhen, China



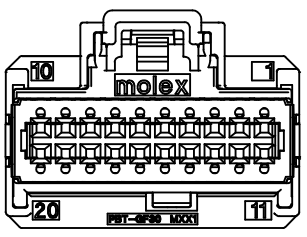

POLARIZATION OPTION A
P/N 34729-0200

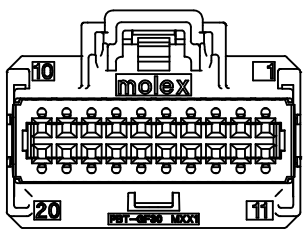

POLARIZATION OPTION B
P/N 34729-0201

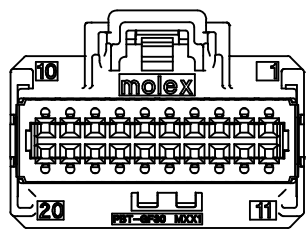

POLARIZATION OPTION C
P/N 34729-0202

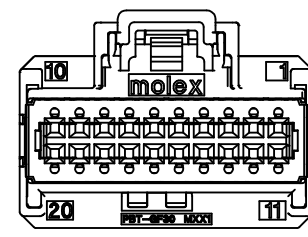

POLARIZATION OPTION D
P/N 34729-0203

- NOTES: VALID UNLESS OTHERWISE SPECIFIED
1. GENERAL:
 - a. APPLICATION SPECIFICATION SEE: AS-34729-020
 - b. PRODUCT SPECIFICATION SEE: PS-34729-020
 - c. PACKAGING SPECIFICATION PER MOLEX DRAWING: PK-31301-201
 - d. PARTS MUST BE IN COMPLIANCE TO MOLEX CHEMICAL SUBSTANCES FOR PRODUCTS AND PACKAGING SPECIFICATION: ES-40000-5015
 - e. DATA MUST BE SUBMITTED UNDER THE MOLEX PART NUMBER TO IMDS (COMPANY ID#13255)
 2. DESIGN - MATERIALS:
 - a. CONNECTOR HOUSING - PBT-GF30
 - b. TPA - PBT-GF30
 3. DESIGN - GEOMETRY:
 - a. THIS IS A 100% CAD GENERATED PART. THE CAD MATHEMATICAL DATA IS THE MASTER FOR THIS PART. FOR DIMENSIONAL OR ANY INFORMATION NOT SHOWN ON THIS DRAWING, ANALYZE THE CAD MODEL.
 - b. GEOMETRIC DIMENSIONS AND TOLERANCES PER ASME Y14.5M - 1994
 - c. EDGES AND UNDIMENSIONED DETAILS PER ISO13715
 - d. CORNERS SHOWN AS SHARP TO BE R 0.2 MAX.
 - e. LETTERING SHALL BE 0.15 MAX RAISED IN 0.25 MAX RECESS PAD. THIS INCLUDES RECYCLING CODE, CAVITY ID, VENDOR IDENTIFICATION, AND CUSTOMER MATERIAL NUMBER.
 - f. VISUAL DEFECTS SHALL MEET COSMETIC STANDARD PS-45499-002 (CLASS C)

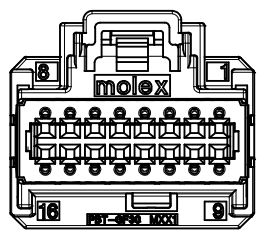

POLARIZATION OPTION A
P/N 34729-0160

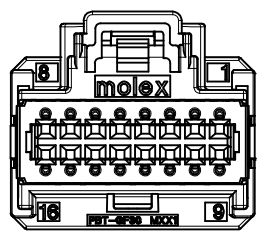

POLARIZATION OPTION B
P/N 34729-0161

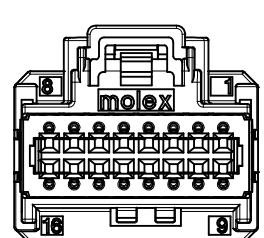

POLARIZATION OPTION C
P/N 34729-0162

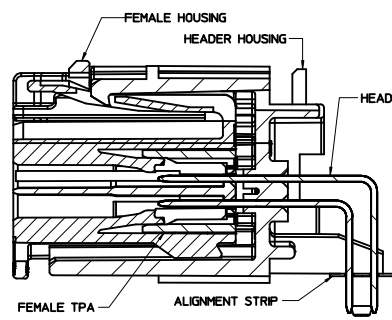

ASSEMBLY SECTION

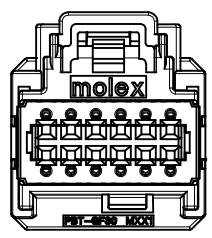

POLARIZATION OPTION A
P/N 34729-0120

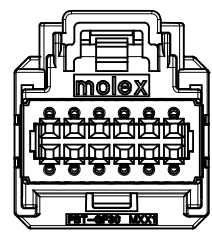

POLARIZATION OPTION B
P/N 34729-0121

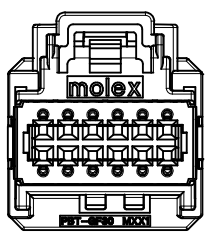

POLARIZATION OPTION C
P/N 34729-0122

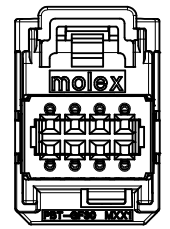

POLARIZATION OPTION A
P/N 34729-0080

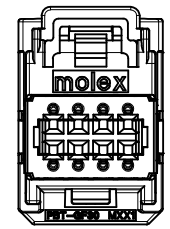

POLARIZATION OPTION B
P/N 34729-0081

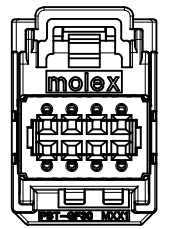

POLARIZATION OPTION C
P/N 34729-0082

INITIAL RELEASE DEC NO. UAU2015-1854 DRAWN: FISCHER01 2015/06/09 CHYK: APPR: RBALMAN 2015/06/13 REV DESCRIPTION D4	QUALITY SYMBOLS	GENERAL TOLERANCES (UNLESS SPECIFIED)	DIMENSION STYLE	SCALE	DESIGN UNITS	THIRD ANGLE PROJECTION
	$\nabla=0$ $\nabla=0$	mm INCH 4 PLACES ± --- ± --- 3 PLACES ± --- ± --- 2 PLACES ± 0.13 ± --- 1 PLACE ± 0.25 ± --- ANGULAR ± 3°	MM ONLY	4:1	METRIC	TITLE 8 - 20 CKT STAC64 (UNSEALED) RECEPTACLE ASSEMBLY
	DRAFT WHERE APPLICABLE MUST REMAIN WITHIN DIMENSIONS	DRAWN BY DATE MDICK 11/21/2008 CHECKED BY DATE CDILLON APPROVED BY DATE SMARCEAU 2010/08/02	MATERIAL NO. SEE CHART	DOCUMENT NO. SD-34729-020	MOLEX INCORPORATED	SHEET NO. 1 OF 2
		THIS DRAWING CONTAINS INFORMATION THAT IS PROPRIETARY TO MOLEX INCORPORATED AND SHOULD NOT BE USED WITHOUT WRITTEN PERMISSION				

APPLICABLE COMPONENTS			APPLICABLE WIRE SIZE	
DESCRIPTION	TYPE	SUPPLIER COMPONENTS PART NO.	WIRE GAGE	MAXIMUM INSULATION DIAMETER
MOLEX CTX64 TERMINAL	Sn	34803-3212	20 AWG	1.90mm
	Sn	34803-3211	22 AWG	1.65mm

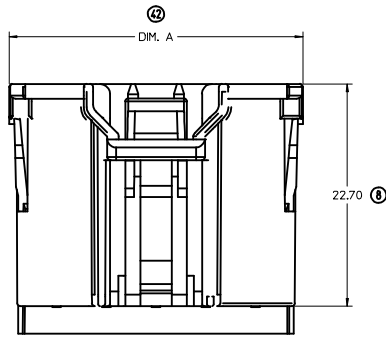

DESCRIPTION	MOLEX ASSEMBLY PART NO.'S	COLOR	DIM. A (mm)	DIM. B (mm)	DIM. C (mm)	DIM. D (mm)	MATING COMPONENT		
							VERTICAL HEADER	RIGHT ANGLE MYLAR HEADER	RIGHT ANGLE PAP HEADER
20 CKT STAC64 RCPT ASSEMBLY - POL A	34729-0200	BLACK	30.00	28.35	22.86	34.35	34690-0200	34691-0200	34691-6200
20 CKT STAC64 RCPT ASSEMBLY - POL B	34729-0201	GRAY					34690-0201	34691-0201	34691-6201
20 CKT STAC64 RCPT ASSEMBLY - POL C	34729-0202	BROWN					34690-0202	34691-0202	34691-6202
20 CKT STAC64 RCPT ASSEMBLY - POL D	34729-0203	GREEN	24.92	23.27	17.78	29.85	34690-0203	34691-0203	34691-6203
16 CKT STAC64 RCPT ASSEMBLY - POL A	34729-0160	BLACK					34690-0160	34691-0160	34691-6160
16 CKT STAC64 RCPT ASSEMBLY - POL B	34729-0161	GRAY					34690-0161	34691-0161	34691-6161
16 CKT STAC64 RCPT ASSEMBLY - POL C	34729-0162	BROWN	19.84	18.19	12.70	27.25	34690-0162	34691-0162	34691-6162
12 CKT STAC64 RCPT ASSEMBLY - POL A	34729-0120	BLACK					34690-0120	34691-0120	34691-6120
12 CKT STAC64 RCPT ASSEMBLY - POL B	34729-0121	GRAY					34690-0121	34691-0121	34691-6121
12 CKT STAC64 RCPT ASSEMBLY - POL C	34729-0122	BROWN	14.76	13.11	7.62	25.45	34690-0122	34691-0122	34691-6122
8 CKT STAC64 RCPT ASSEMBLY - POL A	34729-0080	BLACK					34690-0080	34691-0080	34691-6080
8 CKT STAC64 RCPT ASSEMBLY - POL B	34729-0081	GRAY					34690-0081	34691-0081	34691-6081
8 CKT STAC64 RCPT ASSEMBLY - POL C	34729-0082	BROWN					34690-0082	34691-0082	34691-6082

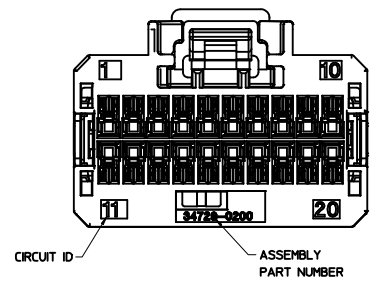
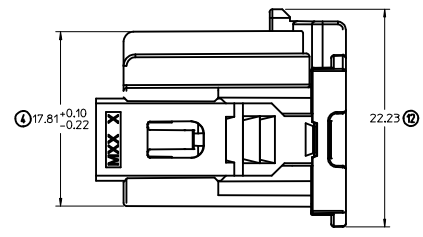
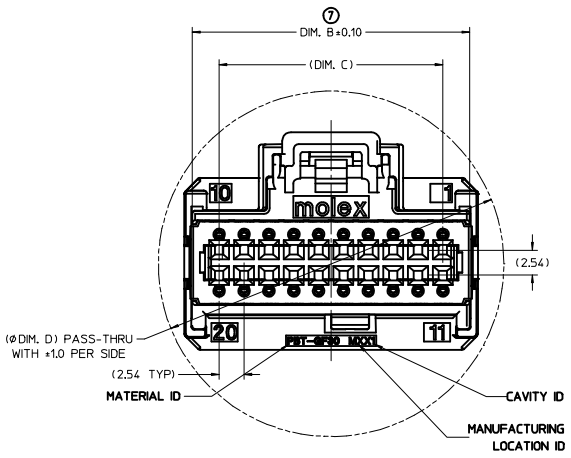
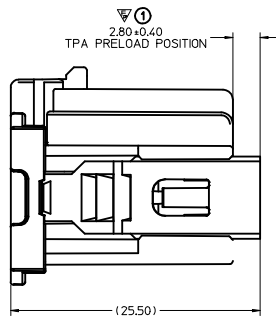

INITIAL RELEASE DEC NO. UAU2015-1854 DRAWN/FISHER01 2015/06/09 CHYD: APPR:BRALMAN 2015/06/13 REV:	QUALITY SYMBOLS	GENERAL TOLERANCES (UNLESS SPECIFIED)	DIMENSION STYLE	SCALE	DESIGN UNITS	THIRD ANGLE PROJECTION
	▽=0 ▽=0	mm INCH 4 PLACES ± --- ± --- 3 PLACES ± --- ± --- 2 PLACES ± 0.13 ± --- 1 PLACE ± 0.25 ± --- ANGULAR ± 3 °	MM ONLY	4:1	METRIC	☉ ☐
	DRAFT WHERE APPLICABLE MUST REMAIN WITHIN DIMENSIONS	DRAWN BY DATE MDICK 11/21/2008 CHECKED BY DATE CDILLON APPROVED BY DATE SMARCEAU 2010/08/02	TITLE	8 - 20 CKT STAC64 (UNSEALED) RECEPTACLE ASSEMBLY		
		MATERIAL NO. SEE CHART SIZE D	MOLEX INCORPORATED DOCUMENT NO. SD-34729-020 SHEET NO. 2 OF 2			