



Chipsmall Limited consists of a professional team with an average of over 10 year of expertise in the distribution of electronic components. Based in Hongkong, we have already established firm and mutual-benefit business relationships with customers from,Europe,America and south Asia,supplying obsolete and hard-to-find components to meet their specific needs.

With the principle of “Quality Parts,Customers Priority,Honest Operation,and Considerate Service”,our business mainly focus on the distribution of electronic components. Line cards we deal with include Microchip,ALPS,ROHM,Xilinx,Pulse,ON,Everlight and Freescale. Main products comprise IC,Modules,Potentiometer,IC Socket,Relay,Connector.Our parts cover such applications as commercial,industrial, and automotives areas.

We are looking forward to setting up business relationship with you and hope to provide you with the best service and solution. Let us make a better world for our industry!



Contact us

Tel: +86-755-8981 8866 Fax: +86-755-8427 6832

Email & Skype: info@chipsmall.com Web: www.chipsmall.com

Address: A1208, Overseas Decoration Building, #122 Zhenhua RD., Futian, Shenzhen, China



POWR-BLOK™ Modules



| | |
|--|--------------|
| Powr-Blok™ Modules: Introduction | 1 |
| Fuse Modules | 2 |
| 2-Position ATO® Style Fuse and Circuit Breaker Module | 2 |
| 4-Position ATO® Style Fuse and Circuit Breaker Module | 2 |
| 7-Position ATO® Style Fuse and Circuit Breaker Module | 3 |
| 4-Position MINI® Style Fuse Module | 3 |
| 6-Position MINI® Style Fuse Module | 4 |
| 8-Position MINI® Style Fuse Module | 4 |
| 2-Position MAXI™ Style Fuse Module | 5 |
| 4-Position MAXI™ Style Fuse Module | 5 |
| Relay Modules | 6 |
| 1-Position ISO Relay Module | 6 |
| 2-Position ISO Relay Module | 6 |
| 3-Position Micro Relay Module | 7 |
| 1-Position 9 Pin Relay Module | 7 |
| 2-Position 280 Micro Relay + 2 Position MINI® Style Fuse | 8 |
| 1-Position Power Relay Module | 8 |
| 2-Pin Flasher Module | 9 |
| Specialty Modules | 10 |
| Blank Module | 10 |
| 2-Position Blank Module | 10 |
| Power Tap Module | 11 |
| 2-Stud Assembly Module | 11 |
| 4-Stud Assembly Module | 12 |
| 2-Position Push Button Circuit Breaker Module | 12 |
| Storage Module/Drawer Insert | 13 |
| Splash Proof Cover for: 4-Position MINI® Fuse Module | 13 |
| Assembly/Mounting Accessories | 14 |
| Assembly Accessories—BLOK-LOKS™ | 14 |
| Mounting Accessories—Mounting Standoffs | 14 |
| Mounting Accessories—Mounting Module | 15 |
| Mounting Leg | 15 |
| Mounting Accessories—Flush Mounting Leg | 16 |
| Side Mounting Bracket | 16 |
| Terminals | 17-21 |
| Starter Terminals | 22 |
| Terminal Loks | 23 |

POWR-BLOK™ MODULES

Description

The Littelfuse POWR-BLOKS™ system gives you unlimited flexibility to design electrical distribution systems. It's a totally modular way to build your own junction box. POWR-BLOKS are perfect for applications where space or vehicle function demand a tailor made approach. The Littelfuse POWR-BLOKS can be modified, re-sized, reconfigured or added to at any time.

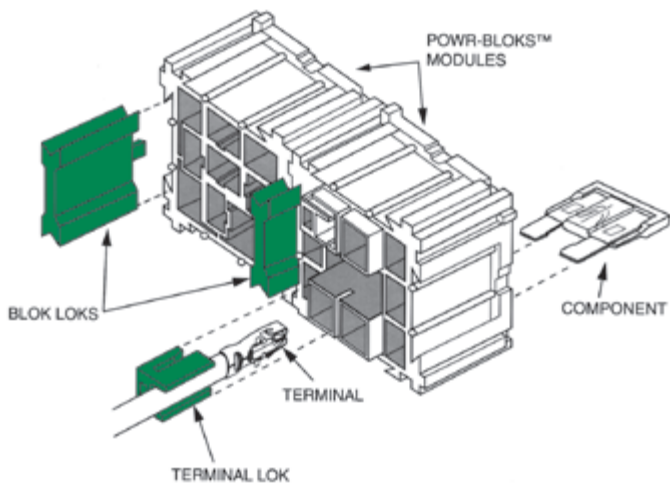

How to use the Littelfuse POWR-BLOKS system

1. Identify the electrical system parameters
 - Space availability and requirements
 - Circuit protection components
 - Relay and flasher components
 - Components for special needs
2. Select the Littelfuse POWR-BLOKS components. Lay out the electrical panel as designed. Then determine the appropriate type and quantity of POWR-BLOKS modules, BLOK LOKS and TERMINAL LOKS you need.
3. Build the panel by row. POWR-BLOKS can be assembled without special tools. Assemble the block from the rear by placing all modules face down on a flat surface. POWR-BLOKS should be designed by row, either going across or up and down.
4. Use BLOK LOKS to interconnect modules. BLOK LOKS are used to connect and stack POWR-BLOKS modules. Press together a row of modules and insert green BLOK LOKS until they snap into place. Repeat this procedure to interlock all assembled rows.
5. Add mounting modules. Once a POWR-BLOKS panel is assembled, add mounting modules that are most suitable for your application. Mounting options include surface mounting legs, a side mounting bracket and a mounting module with three different sized spacers.
6. Plug in terminated wiring. Wire your POWR-BLOKS panel and plug in the terminated wires, then insert the optional matching TERMINAL LOKS devices. Littelfuse TERMINAL LOKS are designed to fit special POWR-BLOKS modules and inserted in the same manner as BLOK LOKS.

Mechanical Strength for Any Application

POWR-BLOKS modules are molded from glass reinforced nylon for dimensional stability, excellent rigidity, high and low temperature resistance and tensile strength:

Specifications

| | |
|---------------------|--|
| Test | POWR-BLOKS™ Standard |
| Voltage Rating | 48VDC |
| Temperature range | -40°C to +125°C |
| Durability | Minimum 50 cycles of engagement/disengagement |
| Drop | 1.22 meters onto wooden platform |
| Thermal Shock | 5 Cycles from -40°C to +125°C |
| Mechanical Shock | 50g in each of 3 mutually perpendicular axis |
| Fluid Compatibility | Gasoline, diesel fuel, motor oil, antifreeze, brake fluid, ATF |

*Max. Current Indication

The information listed as Max. current indication is to be used as a guideline only. The maximum allowable rating of the fuses used depends on design criteria such as maximum current, nominal current the duration for which the circuits are energized, as well as external factors as ambient temperature. All modules should therefore be tested as an assembly, and users should make their own evaluation to determine the suitability of the product for their specific applications.

The information and illustrations given in this catalogue are believed to be reliable and accurate. Littelfuse makes no warranties as to their accuracy or completeness, and disclaims any liability in connection with their use. Littelfuse's only obligations are those in the standard terms of sale for this product and Littelfuse will not be liable for any consequential or other damages arising out of the use or misuse of this product. Littelfuse reserves the right to make changes to the contents hereof without notice. It is suggested that at the time of inquiry Littelfuse Sales personnel be contacted directly for verification of published specifications and product availability.

2-POSITION ATO® STYLE FUSE AND CIRCUIT BREAKER MODULE

RoHS

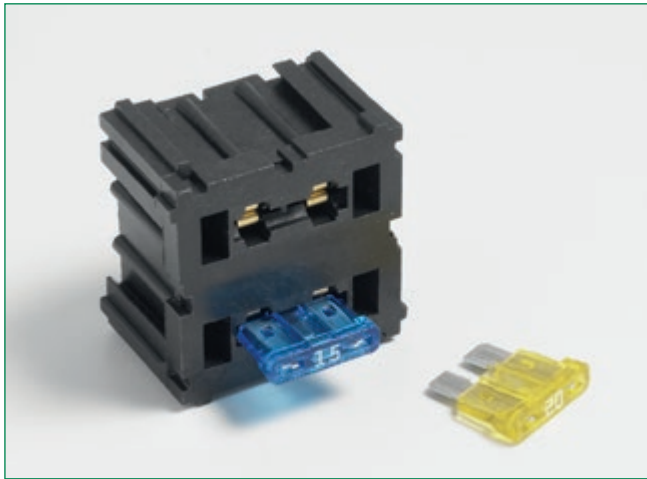

Dimensions

Dimensions in mm

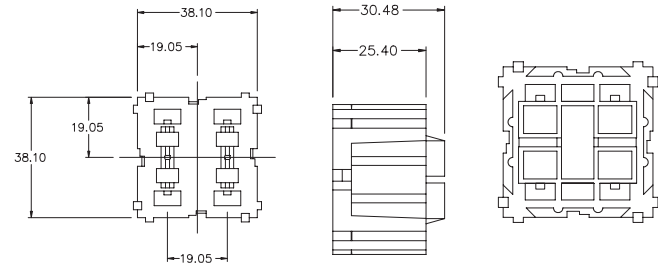

Ratings

| Part Number | Max. Current Indication | Terminals (see according section) | Terminal Loks (see according section) |
|---------------------|-------------------------|--------------------------------------|--|
| 03540501Z (40 pcs.) | 60A | Type 1 or 7 | Type 4, 5 or 6 |

4-POSITION ATO® STYLE FUSE AND CIRCUIT BREAKER MODULE

RoHS

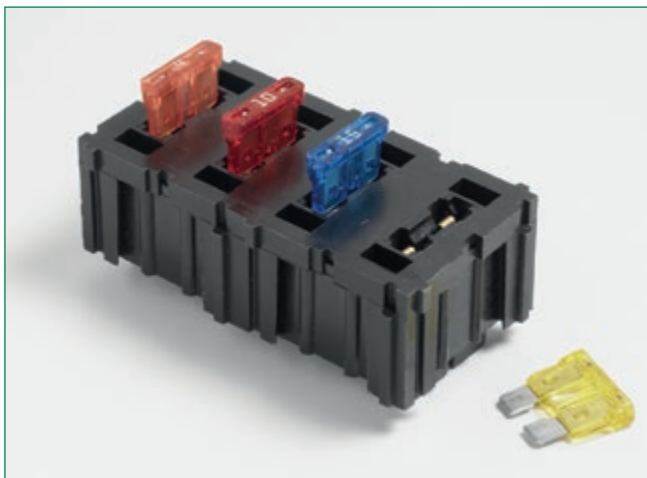

Dimensions

Dimensions in mm

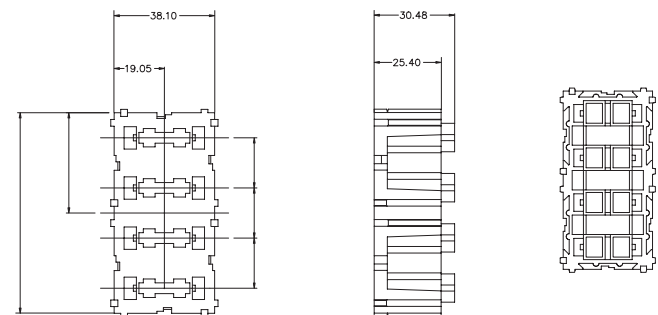

Ratings

| Part Number | Max. Current Indication | Terminals (see according section) | Terminal Loks (see according section) |
|---------------------|-------------------------|--------------------------------------|--|
| 03540502Z (20 pcs.) | 120A | Type 1 or 7 | Type 4, 5, 6 or 7 |

7-POSITION ATO® STYLE FUSE AND CIRCUIT BREAKER MODULE

RoHS



Dimensions

Dimensions in mm

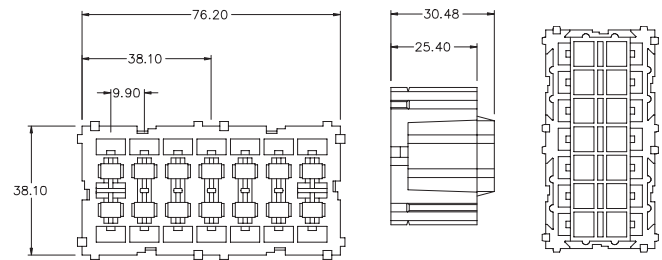

Ratings

| Part Number | Max. Current Indication | Terminals (see according section) | Terminal Loks (see according section) |
|---------------------|-------------------------|--------------------------------------|--|
| 03540503Z (20 pcs.) | 120A | Type 1 or 7 | Type 4 or 5 |

4-POSITION MINI® STYLE FUSE MODULE

RoHS



Dimensions

Dimensions in mm

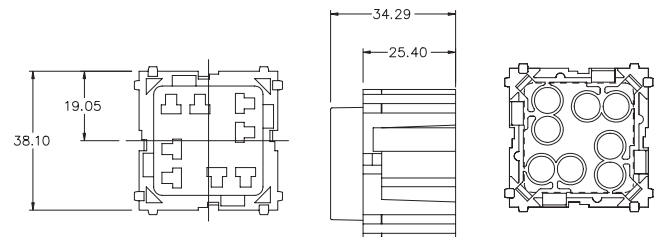

Ratings

| Part Number | Max. Current Indication | Terminals (see according section) | Terminal Loks (see according section) |
|---------------------|-------------------------|--------------------------------------|--|
| 03540532Z (40 pcs.) | 60A | Type 6 | — |

6-POSITION MINI® STYLE FUSE MODULE

RoHS



Dimensions

Dimensions in mm

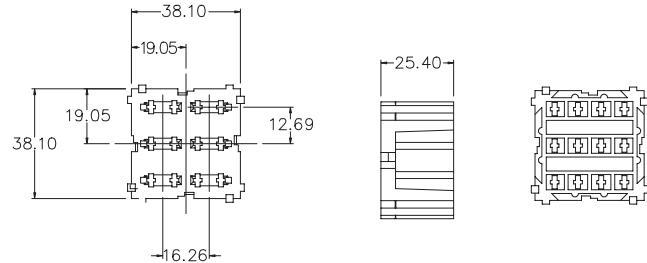

Ratings

| Part Number | Max. Current Indication | Terminals (see according section) | Terminal Loks (see according section) |
|---------------------|-------------------------|--------------------------------------|--|
| 03540543Z (40 pcs.) | 60A | Type 8 | - |

8-POSITION MINI® STYLE FUSE MODULE

RoHS



Dimensions

Dimensions in mm

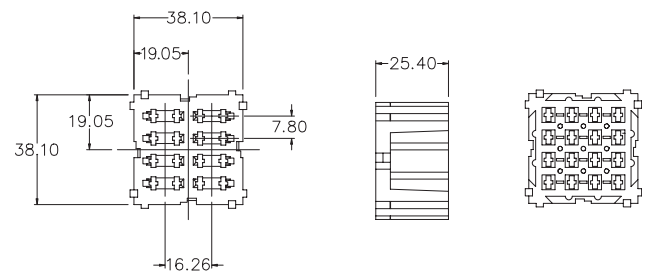

Ratings

| Part Number | Max. Current Indication | Terminals (see according section) | Terminal Loks (see according section) |
|---------------------|-------------------------|--------------------------------------|--|
| 03540544Z (40 pcs.) | 60A | Type 8 | - |

2-POSITION MAXI™ STYLE FUSE MODULE

RoHS

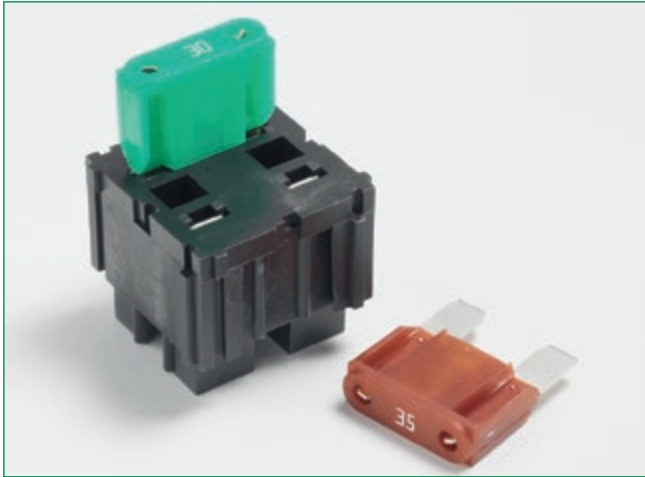

Dimensions

Dimensions in mm

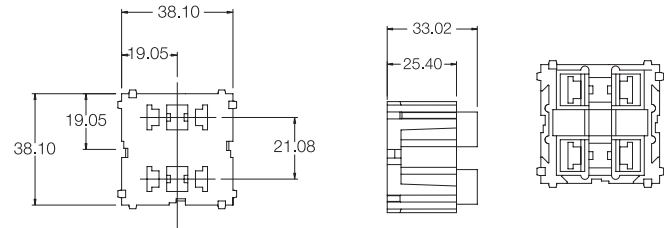

Ratings

| Part Number | Max. Current Indication | Terminals (see according section) | Terminal Loks (see according section) |
|---------------------|-------------------------|--------------------------------------|--|
| 03540549Z (40 pcs.) | 80A | Type 2 | Type 8 |

4-POSITION MAXI™ STYLE FUSE MODULE

RoHS



Dimensions

Dimensions in mm

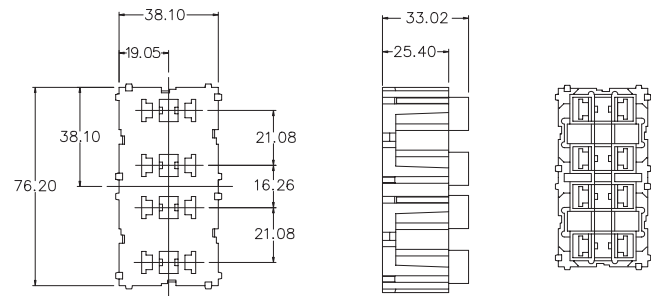

Ratings

| Part Number | Max. Current Indication | Terminals (see according section) | Terminal Loks (see according section) |
|---------------------|-------------------------|--------------------------------------|--|
| 03540505Z (20 pcs.) | 160A | Type 2 | Type 8 |

1-POSITION ISO RELAY MODULE

Alternative for: 3 pin flasher module

RoHS

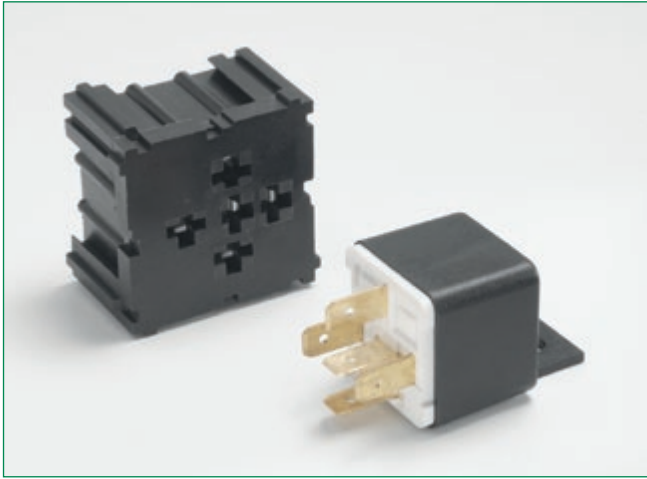

Dimensions

Dimensions in mm

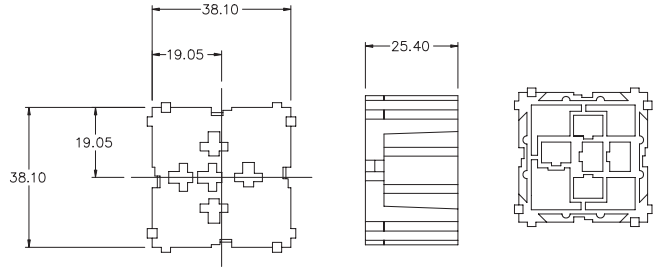

Ratings

| Part Number | Remarks | Terminals (see according section) | Terminal Loks (see according section) |
|---------------------|---------|--------------------------------------|--|
| 03540506Z (40 pcs.) | - | Type 3 | Type 1 |

2-POSITION ISO RELAY MODULE

Alternative for: 3 pin flasher module

RoHS

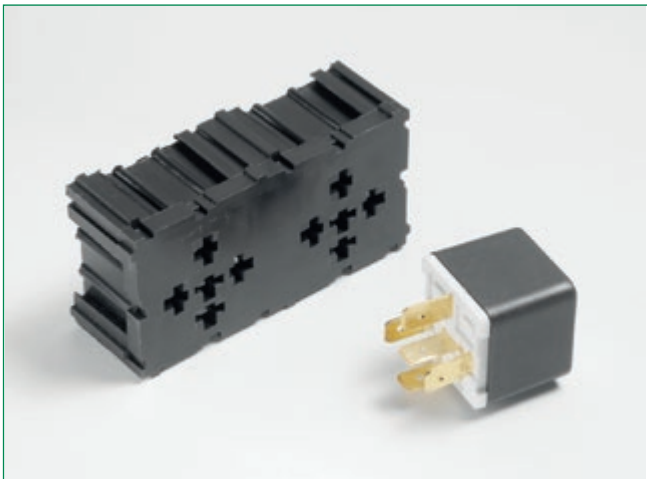

Dimensions

Dimensions in mm

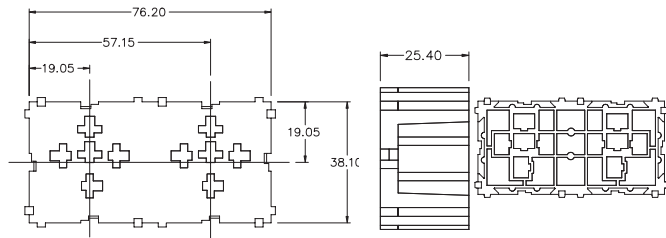

Ratings

| Part Number | Remarks | Terminals (see according section) | Terminal Loks (see according section) |
|---------------------|---------|--------------------------------------|--|
| 03540536Z (20 pcs.) | - | Type 3 | Type 1 |

3-POSITION MICRO RELAY MODULE

RoHS

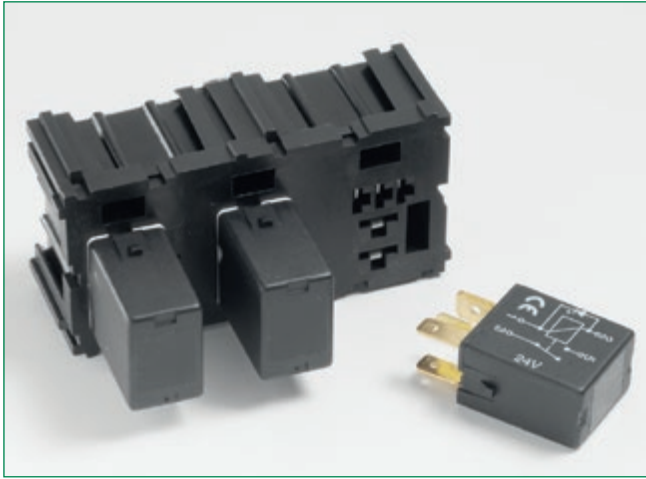

Dimensions

Dimensions in mm

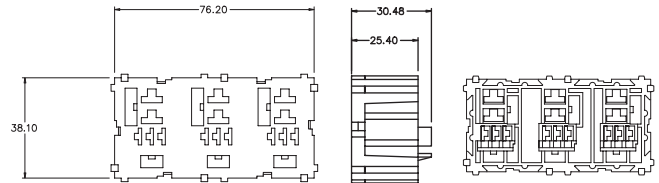

Ratings

| Part Number | Max. Current Indication | Terminals (see according section) | Terminal Loks (see according section) |
|---------------------|-----------------------------------|--------------------------------------|--|
| 03540507Z (20 pcs.) | Coil and normally closed contacts | Type 5 | Type 3 |
| 03540507Z (20 pcs.) | Normally open contacts | Type 3 | Type 2 |

1-POSITION 9 PIN RELAY MODULE

RoHS

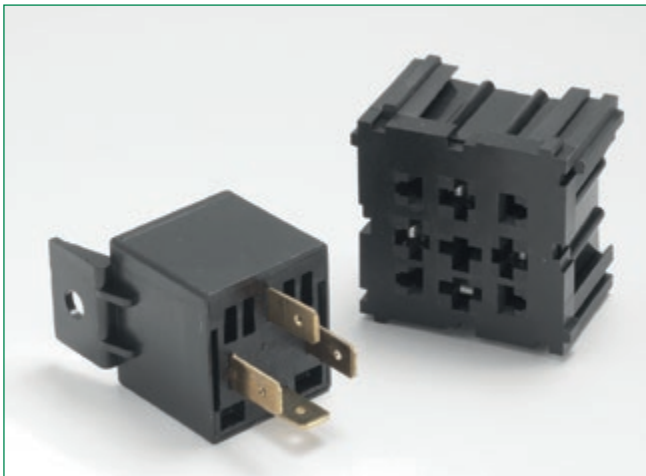

Dimensions

Dimensions in mm

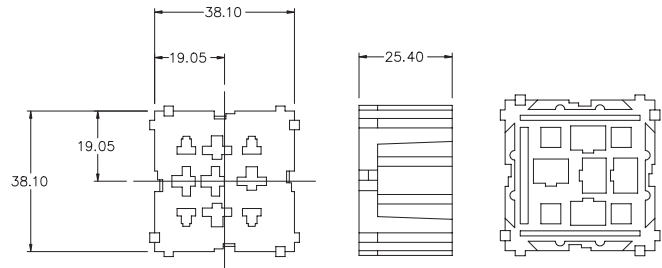

Ratings

| Part Number | Max. Current Indication | Terminals (see according section) | Terminal Loks (see according section) |
|---------------------|-------------------------|--------------------------------------|--|
| 03540542Z (40 pcs.) | 5 "Inner" pins | Type 3 | Type 1 |
| 03540542Z (40 pcs.) | 4 "Outer" pins | Type 6 | - |

2-POSITION 280 MICRO RELAY + 2 POSITION MINI® STYLE FUSE

RoHS



Dimensions

Dimensions in mm

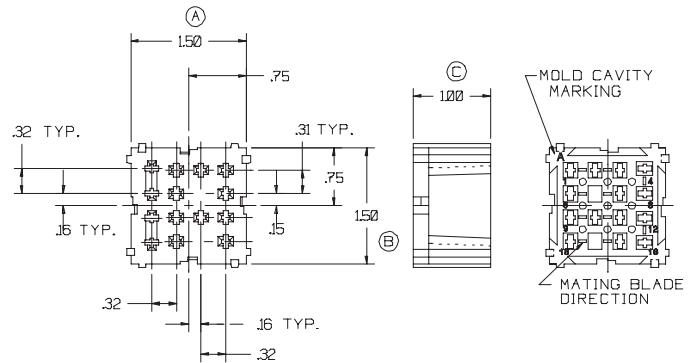

Ratings

| Part Number | Max. Current Indication | Terminals (see according section) | Terminal Loks (see according section) |
|---------------------|-----------------------------|--------------------------------------|--|
| 03540551Z (40 pcs.) | Max. current indication 30A | Type 8 | - |

1-POSITION POWER RELAY MODULE

RoHS



Dimensions

Dimensions in mm

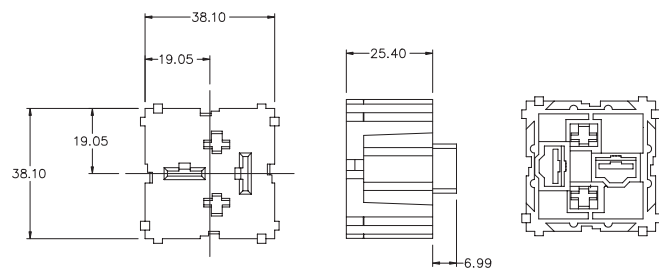

Ratings

| Part Number | Max. Current Indication | Terminals (see according section) | Terminal Loks (see according section) |
|---------------------|-------------------------|--------------------------------------|--|
| 03540535Z (40 pcs.) | Coil | Type 3 | Type 1 |
| 03540535Z (40 pcs.) | Contacts | Type 4 | - |

2-PIN FLASHER MODULE

RoHS

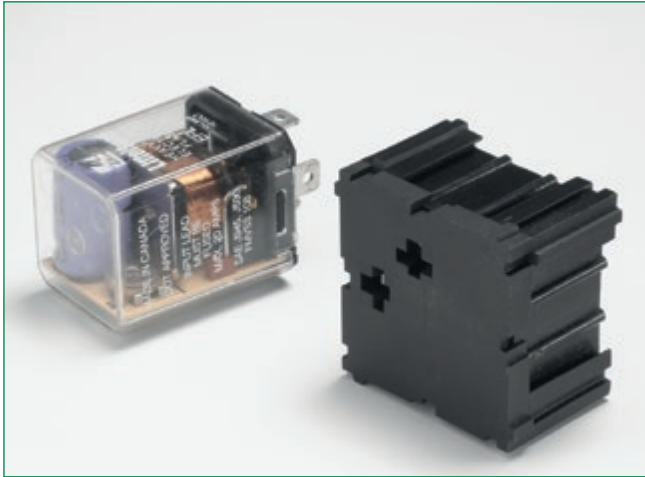

Dimensions

Dimensions in mm

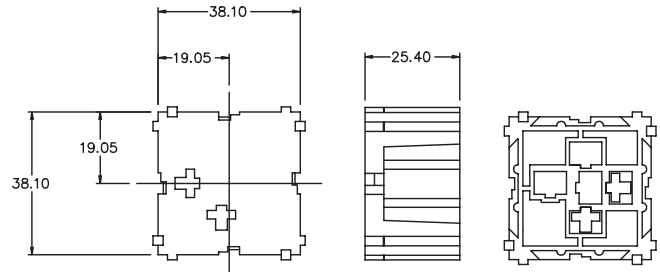

Ratings

| Part Number | Max. Current Indication | Terminals (see according section) | Terminal Loks (see according section) |
|---------------------|-------------------------|--------------------------------------|--|
| 03540508Z (40 pcs.) | - | Type 3 | Type 1 |

BLANK MODULE

RoHS

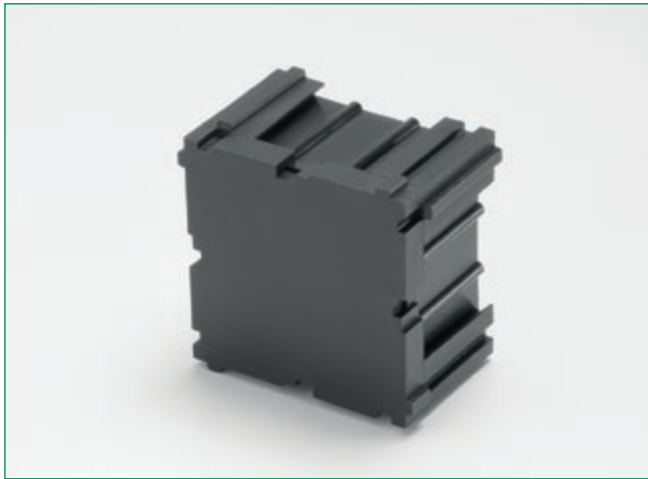

Dimensions

Dimensions in mm

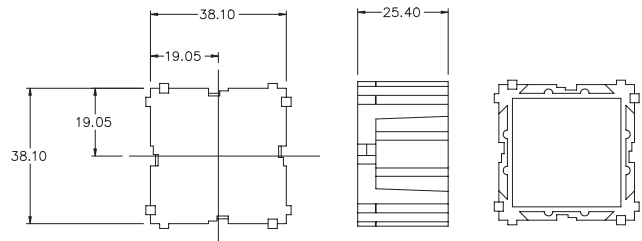

Ratings

| Part Number | Remarks |
|---------------------|---------|
| 03540520Z (40 pcs.) | - |

2-POSITION BLANK MODULE

RoHS



Dimensions

Dimensions in mm

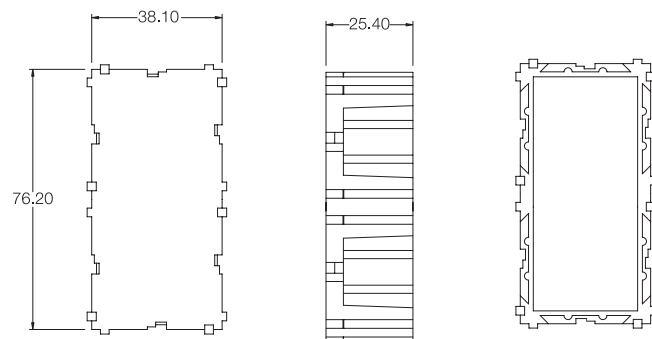

Ratings

| Part Number | Remarks |
|---------------------|---------|
| 03540550Z (20 pcs.) | - |

POWER TAP MODULE

RoHS

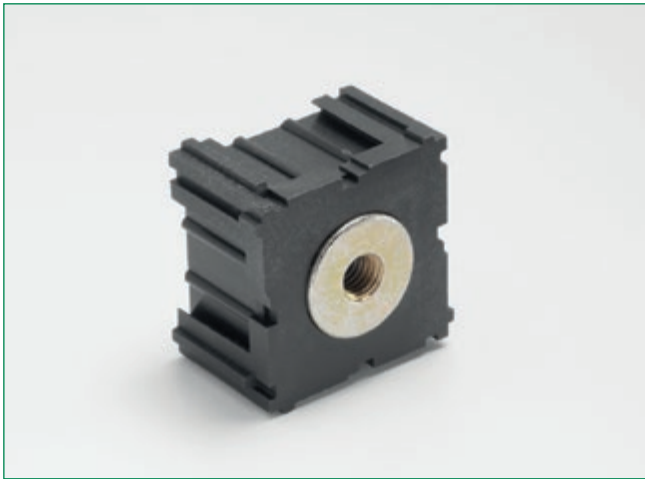

Dimensions

Dimensions in mm

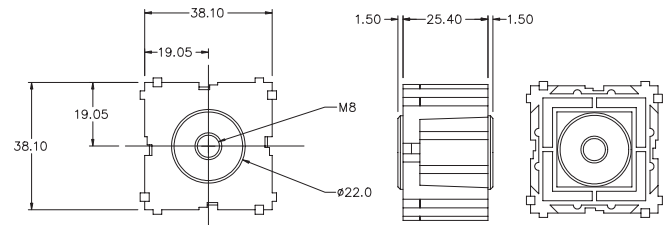

Ratings

| Part Number | Remarks |
|----------------------|-----------------------|
| 03540539Z (40 pcs.) | M8 Tread Metric |
| 03540512Z (100 pcs.) | 1/4 inch - 20 thread |
| 03540513Z (100 pcs.) | 5/16 inch - 18 thread |

2-STUD ASSEMBLY MODULE

RoHS



Dimensions

Dimensions in mm

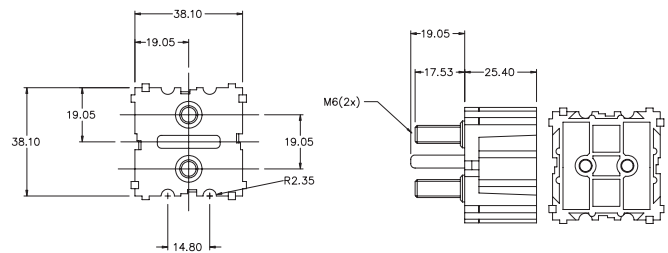

Ratings

| Part Number | Remarks |
|---------------------|-------------------|
| 03540537Z (20 pcs.) | M6 Thread, Metric |

4-STUD ASSEMBLY MODULE

RoHS

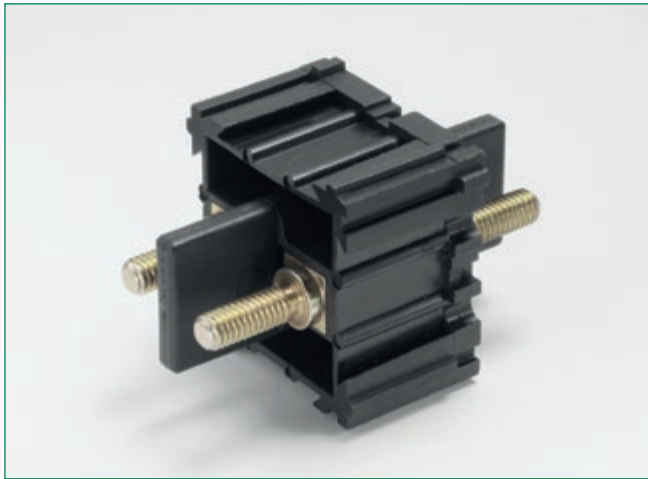

Dimensions

Dimensions in mm

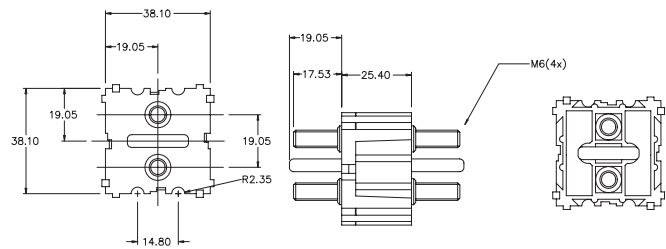

Ratings

| Part Number | Remarks |
|---------------------|------------------|
| 03540538Z (20 pcs.) | M6 Thread Metric |

2-POSITION PUSH BUTTON CIRCUIT BREAKER MODULE

RoHS



Dimensions

Dimensions in mm

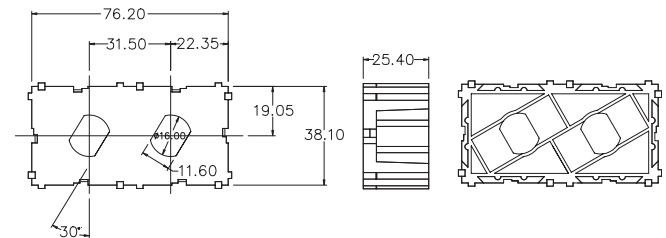

Ratings

| Part Number | Remarks |
|---------------------|---------|
| 03540504Z (20 pcs.) | - |

STORAGE MODULE/DRAWER INSERT

RoHS

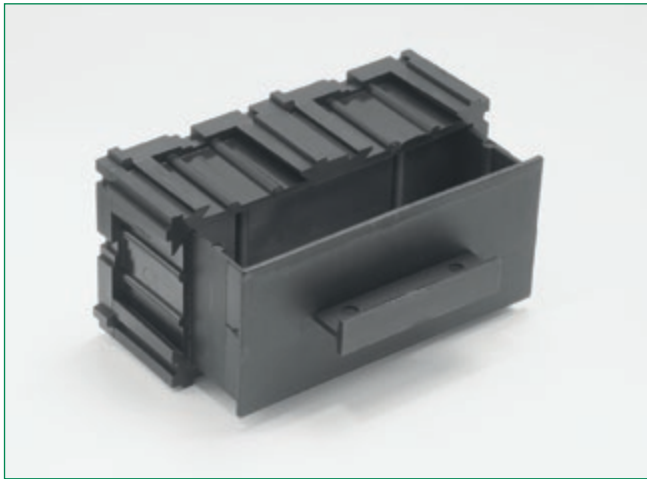

Dimensions

Dimensions in mm

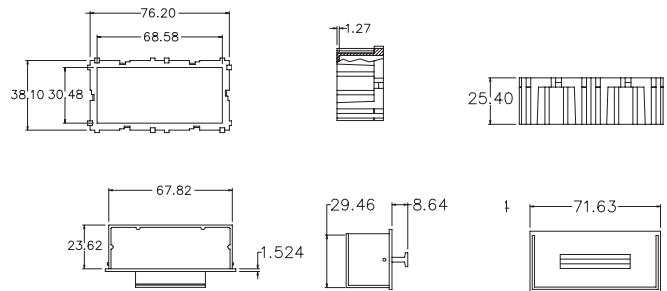

Ratings

| Part Number | Remarks |
|---------------------|---------|
| 03540521Z (20 pcs.) | Body |
| 03540522Z (20 pcs.) | Drawer |

SPLASH PROOF COVER FOR: 4-POSITION MINI® FUSE MODULE

RoHS

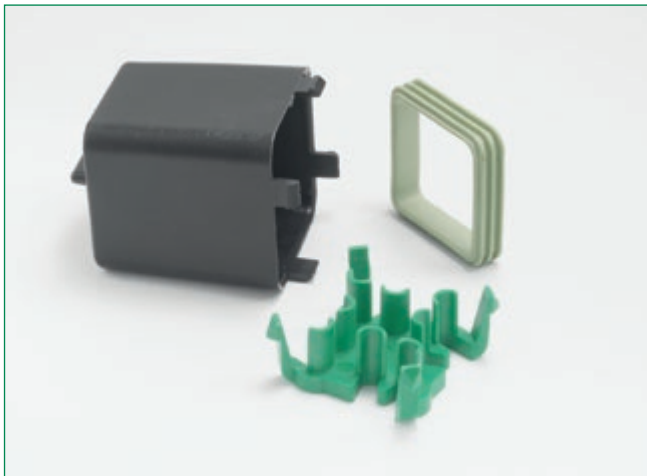

Dimensions

Dimensions in mm

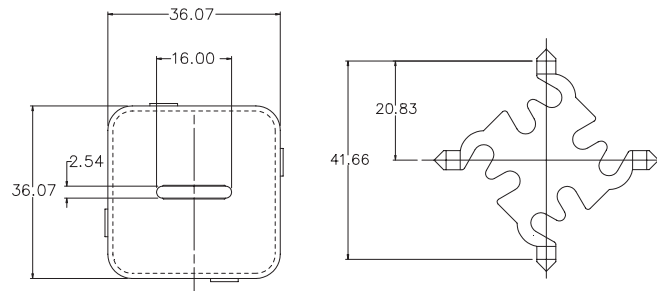

Ratings

| Part Number | Remarks |
|---------------------|---------|
| 03540534Z (20 pcs.) | Cover |
| 03540533Z (20 pcs.) | Lock |
| 09130085Z (20 pcs.) | Seal |

ASSEMBLY ACCESSORIES—BLOK LOKS™

RoHS

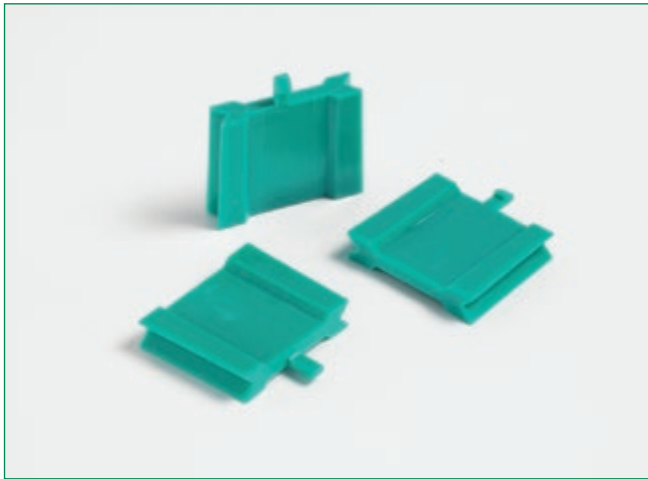

Dimensions

Dimensions in mm

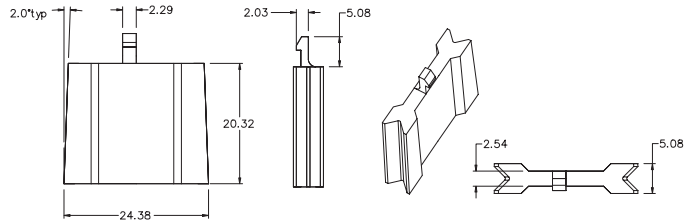

Ratings

| Part Number | Remarks |
|----------------------|---------|
| 03540523Z (250 pcs.) | - |

MOUNTING ACCESSORIES—MOUNTING STANDOFFS

RoHS



Dimensions

Dimensions in mm

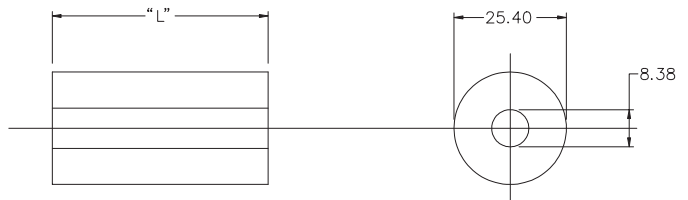

Ratings

| Part Number | Remarks |
|---------------------|--------------------|
| 03540515Z (10 pcs.) | 0.75 Inch / 19mm |
| 03540516Z (10 pcs.) | 1 Inch / 25.4mm |
| 03540517Z (10 pcs.) | 1.25 Inch / 31.7mm |

MOUNTING ACCESSORIES—MOUNTING MODULE

RoHS

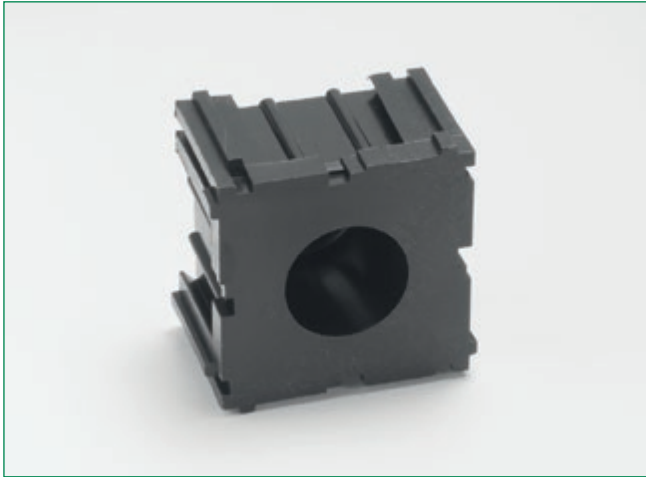

Dimensions

Dimensions in mm

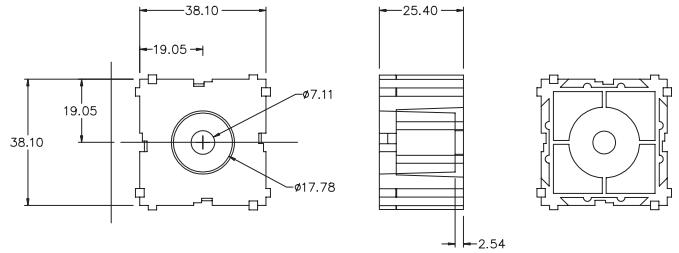

Ratings

| Part Number | Remarks |
|---------------------|---------|
| 03540514Z (40 pcs.) | — |

MOUNTING LEG

RoHS



Dimensions

Dimensions in mm

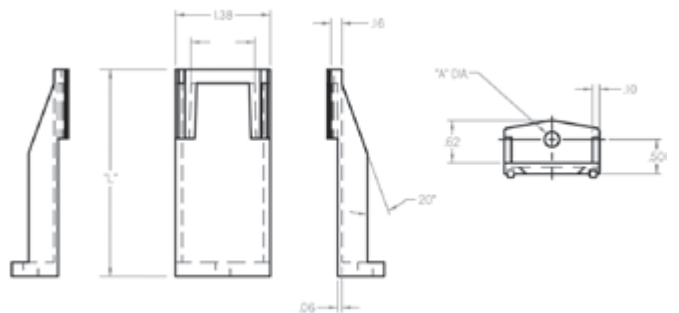

Ratings

| Part Number | Remarks |
|---------------------|--------------------|
| 03540541Z (50 pcs.) | 2.50 Inch / 63.5mm |
| 03540518Z (50 pcs.) | 3 Inch / 76.2mm |

MOUNTING ACCESSORIES—FLUSH MOUNTING LEG

RoHS



Dimensions

Dimensions in mm

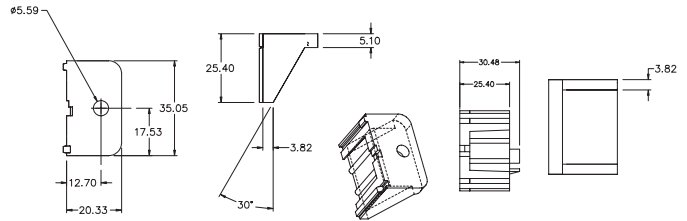

Ratings

| Part Number | Remarks |
|---------------------|---------|
| 03540519Z (50 pcs.) | — |

SIDE MOUNTING BRACKET

RoHS

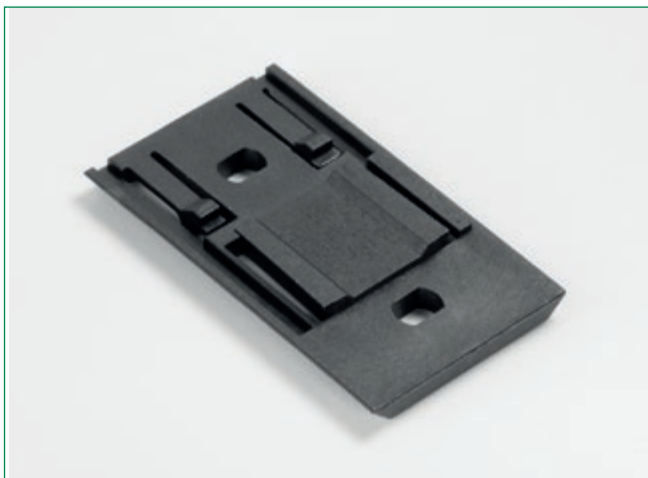

Dimensions

Dimensions in mm

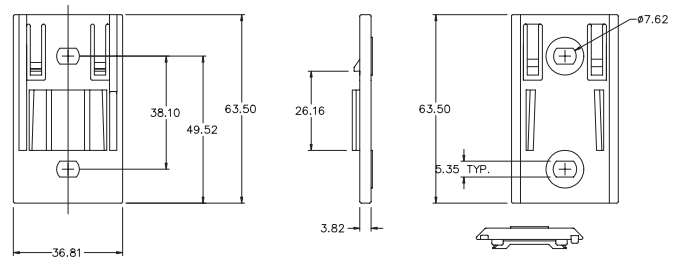

Ratings

| Part Number | Remarks |
|---------------------|---------|
| 03540540Z (50 pcs.) | — |

TERMINAL TYPE 1

RoHS



Terminal Loks

| Description | Wire Diam. | Type of terminal loks |
|---|--------------------------------------|-----------------------|
| For part number: 354501 / 354502 / 354503 | 0.50 - 2 mm ² | 4 |
| For part number: 354501 / 354502 / 354503 | 0.50 - 2 & 3.3 - 5.3 mm ² | 5 |
| For part number: 354501 / 354502 | 0.50 - 2 mm ² | 6 |
| For part number: 354502 | 0.50 - 2 mm ² | 7 |

Ratings

| Part Number | Description | Wire Diam. | Material |
|---|---------------------------|---|-------------------------------|
| 913-070 (Reeled per 2200 pcs) 0913070001 (Single per 250 pcs) | Heavy Duty + spring clip* | 0.5-0.8 mm ² / 18-20AWG 0.5-0.8 mm ² / 18-20AWG | Brass |
| 913-071 (Reeled per 2200 pcs) 913-071XS (Reeled per 2200 pcs) | Heavy Duty + spring clip* | 1.33-2.09 mm ² / 14-16AWG 1.33-2.09 mm ² / 14-16AWG | Brass Silver plated copper |
| 0913071001 (Single per 250 pcs) 913-072 (Reeled per 2200 pcs) | Heavy Duty + spring clip* | 1.33-2.09 mm ² / 14-16AWG 3.32-5.37 mm ² / 10-12AWG | Brass |
| 913-072XS (Reeled per 2200 pcs) 0913072001 (Single per 250 pc) | Heavy Duty + spring clip* | 3.32-5.37 mm ² / 10-12AWG 3.32-5.37 mm ² / 10-12AWG | Silver plated copper Brass |
| 913-058 (Reeled per 4500 pcs) 0913058001 (Single per 250 pcs) | Standard Duty | 0.5-0.8 mm ² / 18-20AWG 0.5-0.8 mm ² / 18-20AWG | Brass |
| 913-059 (Reeled per 4500 pcs) 0913059001 (Single per 250 pcs) | Standard Duty | 1.33-2.09 mm ² / 14-16AWG 1.33-2.09 mm ² / 14-16 AWG | Brass |
| 913-060 (Reeled per 4500 pcs) 0913060001 (Single per 250 pcs) | Standard Duty | 3.32-5.37 mm ² / 10-12AWG 3.32-5.37 mm ² / 10-12AWG | Brass |

* Spring clip material: Stainless steel

TERMINAL TYPE 2

RoHS



Terminal Loks

| Description | Wire Diam. | Type of terminal loks |
|-------------------------|--------------------------|-----------------------|
| For part number: 354505 | 0,50 - 2 mm ² | 8 |

Ratings

| Part Number | Description | Wire Diam. | Material |
|--|---------------|--|---------------------|
| 913-063 (Reeled per 1200 pcs) 0913063001 (Single per 250 pcs) | Female 8.0 mm | 0.82-1.33 mm ² / 18-16AWG 0.82-1.33 mm ² / 18-16AWG | Silver plated brass |
| 913-064 (Reeled per 1200 pcs) 0913064001 (Single per 250 pcs) | Female 8.0 mm | 2.09-3.32 mm ² / 14-12AWG 2.09-3.32 mm ² / 14-12AWG | Silver plated brass |
| 913-068 (Reeled 1200 pcs) 0913068001 (Single per 250 pcs) | Female 8.0 mm | 5.37mm ² / 10AWG 5.37mm ² / 10AWG | Silver plated brass |

TERMINAL TYPE 3

RoHS



Terminal Loks

| Description | Wire Diam. | Type of terminal loks |
|--|------------|-----------------------|
| For part number: 354506 / 354508 / 354535 / 354536 | - | 1 |
| For part number: 354505 | - | 2 |

Ratings

| Part Number | Description | Wire Diam. | Material |
|--|-------------|--|------------------|
| 913-053 (Reeled per 2000 pcs) 0913053001 (Single per 250 pcs) | - | 0.5-0.8 mm ² / 18-20AWG 0.5-0.8 mm ² / 18-20AWG | Tin plated brass |
| 913-253 (Reeled per 3000 pcs) | - | 0.5-1.00 mm ² (metric) | Tin plated brass |
| 913-065 (Reeled per 2100 pcs) 0913065001 (Single per 250 pcs) | - | 1.33-2.09 mm ² / 14-16AWG 1.33-2.09 mm ² / 14-16AWG | Tin plated brass |
| 913-265 (Reeled per 2500 pcs) | - | 1.1-2.50 mm ² (metric) | Tin plated brass |
| 913-055 (Reeled per 1900 pcs) 0913055001 (Single per 250 pcs) | - | 3.32-5.37 mm ² / 10-12AWG 3.32-5.37 mm ² / 10-12AWG | Tin plated brass |
| 913-255 (Reeled per 15000 pcs) | - | 4.0-6.0 mm ² (metric) | Tin plated brass |

TERMINAL TYPE 4

RoHS



Ratings

| Part Number | Description | Wire Diam. | Material |
|--|-------------|--|------------------|
| 913-073 (Reeled per 2000 pcs) 0913073001 (Single per 250 pcs) | Female | 3.0-6.0 mm ² /10-12AWG 3.0-6.0 mm ² /10-12AWG | Tin plated Brass |
| 913-074 (Reeled per 1000 pcs) 0913074001 (Single per 250 pcs) | Female | 6.0-10.0 mm ² /8-10AWG 6.0-10.0 mm ² /8-10AWG | Tin plated Brass |

TERMINAL TYPE 5

RoHS



Ratings

| Part Number | Description | Wire Diam. | Material |
|--|-------------|--|---------------------------|
| 913-067 (Reeled per 3500 pcs) 0913067001 (Single per 250 pcs) | Female | 0.82-1.33 mm ² /16-18AWG 0.82-1.33 mm ² /16-18AWG | Tin plated silicon bronze |
| 913-066 (Reeled per 3000 pcs) 0913066001 (Single per 250 pcs) | Female | 2.09-3.32 mm ² /12-14AWG 2.09-3.32 mm ² /12-14AWG | Tin plated silicon bronze |

TERMINAL TYPE 6

RoHS



Ratings

| Part Number | Description | Wire Diam. | Material |
|--|-------------|--|------------------|
| 913-772 (Reeled per 2500 pcs) 0913772001 (Single per 250 pcs) | Female | 0.5-0.8 mm ² /18-20AWG 0.5-0.8 mm ² /18-20AWG | Tin plated brass |
| 913-773 (Reeled per 2500 pcs) 0913773001 (Single per 250 pcs) | Female | 1.33-2.09 mm ² /14-16AWG 1.33-2.09 mm ² /14-16AWG | Tin plated brass |
| 913-774 (Reeled 2000 pcs) 0913774001 (Single per 250 pcs) | Female | 3.32-5.37 mm ² /10-12AWG 3.32-5.37 mm ² /10-12AWG | Tin plated brass |

TERMINAL TYPE 7

RoHS



Ratings

| Part Number | Description | Wire Diam. | Material |
|------------------------|--------------------|----------------------------------|----------|
| 09130075Z (Per 20 pcs) | Bus bar 2 position | 5.0-8.0 mm ² /8-10AWG | Copper |
| 09130076Z (Per 20 pcs) | Bus bar 4 position | 5.0-8.0 mm ² /8-10AWG | Copper |
| 09130077Z (Per 20 pcs) | Bus bar 7 position | 5.0-8.0 mm ² /8-10AWG | Copper |

TERMINAL TYPE 8

RoHS



Ratings

| Part Number | Description | Wire Diam. | Material |
|---------------------------------|-------------|-------------------------|------------------------|
| 913-769 (Reeled per 4200 pcs) | Female | 0.5-1.0 mm ² | Part.Gold plated Brass |
| 0913769001 (Single per 250 pcs) | | 0.5-1.0 mm ² | |
| 913-770 (Reeled per 1000 pcs) | Female | 1.5-2.5 mm ² | Tin plated bronze |
| 0913770001 (Single per 250 pcs) | | 1.5-2.5 mm ² | |

STARTER TERMINALS

RoHS



Description

The starter terminal series are cable lugs for heavy-duty applications such as starter motors and battery connections.

Ratings

| Part Number | mm ² | Mounting Hole | Width (mm) | Material | Plating | Ref. |
|--|-----------------|---------------|------------|----------|---------|-----------------|
| 09130633LXN (50 pcs) 09130633Z (1250 pcs) | 2.5-6.0 | 6.5 mm | 11 | Cu | Sn | 2906 |
| 09130634LXN (50 pcs) 09130634Z (600 pcs) | 6.0-15 | 8.4 mm | 15 | Cu | Sn | 2910 |
| 09130635LXN (50 pcs) 09130635Z (400 pcs) | 10 -25 | 8.4 mm | 15 | Cu | Sn | 2916 |
| 09130636LXN (50 pcs) 09130636Z (200 pcs) | 16-35 | 10.5 mm | 19 | Cu | Sn | 29025 |
| 09130637LXN (50 pcs) 09130637Z (150 pcs) | 25-50 | 10.5 mm | 19 | Cu | Sn | 29035 |
| 09130638LXN (50 pcs) 09130638Z (100 pcs) | 35-70 | 10.5 mm | 19 | Cu | Sn | 29050 |
| 09130639LXN (50 pcs) 09130639Z (50 pcs) | 50-95 | 13.5 mm | 22 | Cu | Sn | 29070 |
| 09130640LXN (50 pcs) 09130640Z (600 pcs) | 16 | 6.4 mm | 11 | Cu | Sn | 2916 HK |
| 09130641LXN (50 pcs) 09130641Z (300 pcs) | 25 | 8.4 mm | 15 | Cu | Sn | 29025 HK |
| 09130642LXN (50 pcs) 09130642Z (200 pcs) | 35 | 8.4 mm | 15 | Cu | Sn | 29035 HK (8.4) |
| 09130643LXN (50 pcs) 09130643Z (150 pcs) | 35 | 10.5 mm | 19 | Cu | Sn | 29035 HK (10.5) |
| 09130644LXN (50 pcs) 09130644Z (100 pcs) | 50 | 8.4 mm | 17 | Cu | Sn | 29050 HK (8.4) |
| 09130645LXN (50 pcs) 09130645Z (125 pcs) | 50 | 10.5 mm | 19 | Cu | Sn | 29050 HK (10.5) |
| 09130646LXN (50 pcs) 09130646Z (75 pcs) | 70 | 10.5 mm | 21 | Cu | Sn | 29070 HK |

TERMINAL LOKS

RoHS

Terminal Lok Type 1



Terminal Lok Type 5



Terminal Lok Type 2



Terminal Lok Type 6

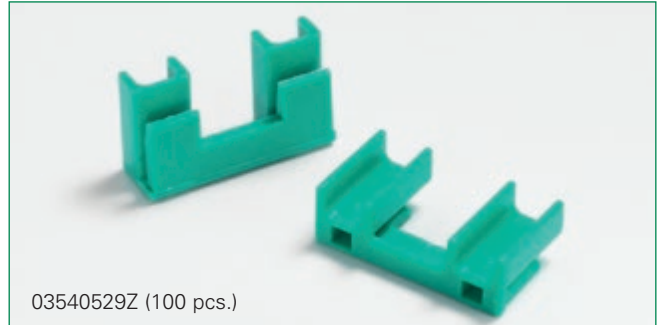

Terminal Lok Type 3



Terminal Lok Type 7

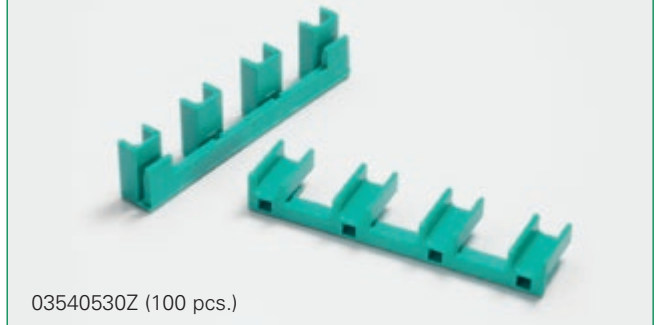

Terminal Lok Type 4

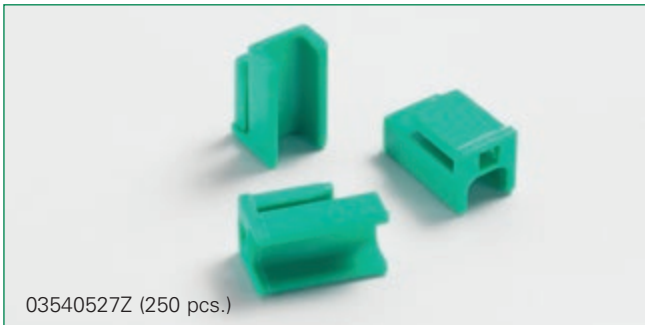

Terminal Lok Type 8

