



Chipsmall Limited consists of a professional team with an average of over 10 year of expertise in the distribution of electronic components. Based in Hongkong, we have already established firm and mutual-benefit business relationships with customers from,Europe,America and south Asia,supplying obsolete and hard-to-find components to meet their specific needs.

With the principle of “Quality Parts,Customers Priority,Honest Operation,and Considerate Service”,our business mainly focus on the distribution of electronic components. Line cards we deal with include Microchip,ALPS,ROHM,Xilinx,Pulse,ON,Everlight and Freescale. Main products comprise IC,Modules,Potentiometer,IC Socket,Relay,Connector.Our parts cover such applications as commercial,industrial, and automotives areas.

We are looking forward to setting up business relationship with you and hope to provide you with the best service and solution. Let us make a better world for our industry!



Contact us

Tel: +86-755-8981 8866 Fax: +86-755-8427 6832

Email & Skype: info@chipsmall.com Web: www.chipsmall.com

Address: A1208, Overseas Decoration Building, #122 Zhenhua RD., Futian, Shenzhen, China



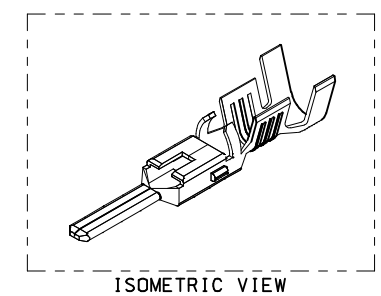
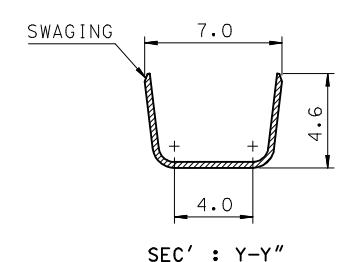
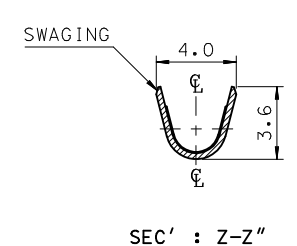
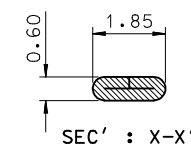
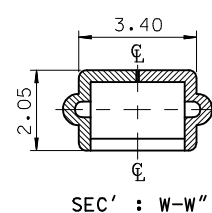
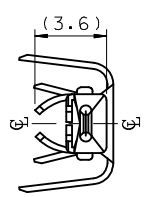
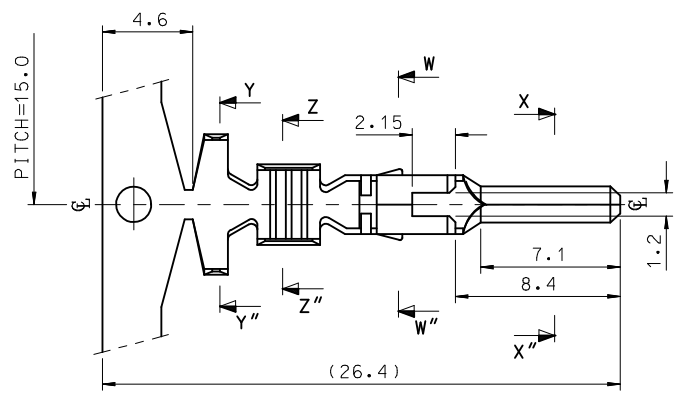

- NOTES.
1. MATERIAL : ⓄBRASS, PRE-TIN PLATED
 2. FINISH : 0.8~1.8μm,Tin(Sn) plating overall
0.3~0.8μm.Copper(Cu) plating
 3. PRODUCT SPECIFICATION : PS-35150-001, PS-35180-002
PS-35180-003, PS-35182-003, PS-35524-001
 4. CRIMPING SPECIFICAITON : CS-35745-001
 5. RECOMMENDED LENGTH OF WIRE STRIP IS 4.0~4.8mm
 6. APPLICABLE WIRE SIZE : AWG #20+#20
AWG #20+#18
AWG #18+#18

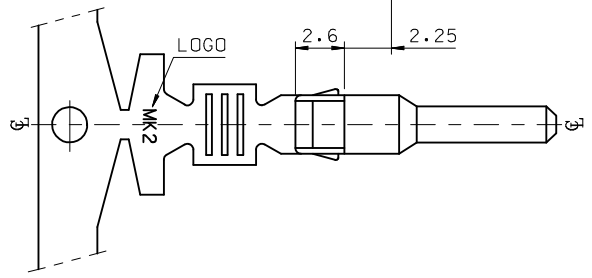
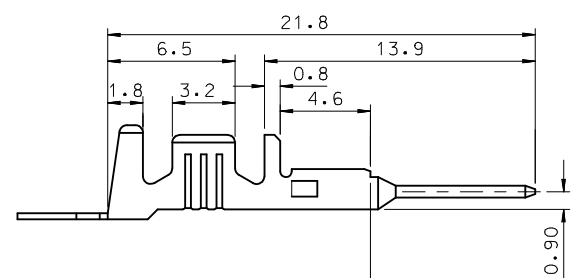

REVISED EC NO: KOR2009-0151 DRWN: JHPARK01 2009/05/18 CHKD: WYANG 2009/06/18 APPR: YUNSIKKIM 2009/07/01	QUALITY SYMBOLS ▽=0 ◻=0	GENERAL TOLERANCES (UNLESS SPECIFIED)		DIMENSION STYLE MM ONLY	SCALE 4:1	DESIGN UNITS METRIC	THIRD ANGLE PROJECTION		
		4 PLACES ± --- ± --- 3 PLACES ± --- ± --- 2 PLACES ± 0.2 ± --- 1 PLACE ± 0.3 ± ---	mm INCH	DRAWN BY JS.KANG	DATE 1998/01/19	TITLE .070 MALE TERMINAL-A (LARGE)			
		ANGULAR ± 1 °		CHECKED BY BK. CHOI	DATE 1998/01/19	MOLEX INCORPORATED			
		DRAFT WHERE APPLICABLE MUST REMAIN WITHIN DIMENSIONS		APPROVED BY CW.LEE	DATE 1998/01/19	MATERIAL NO. 357450310	DOCUMENT NO. SD-35745-002	SHEET NO. 1 OF 01	