



Chipsmall Limited consists of a professional team with an average of over 10 year of expertise in the distribution of electronic components. Based in Hongkong, we have already established firm and mutual-benefit business relationships with customers from,Europe,America and south Asia,supplying obsolete and hard-to-find components to meet their specific needs.

With the principle of “Quality Parts,Customers Priority,Honest Operation,and Considerate Service”,our business mainly focus on the distribution of electronic components. Line cards we deal with include Microchip,ALPS,ROHM,Xilinx,Pulse,ON,Everlight and Freescale. Main products comprise IC,Modules,Potentiometer,IC Socket,Relay,Connector.Our parts cover such applications as commercial,industrial, and automotives areas.

We are looking forward to setting up business relationship with you and hope to provide you with the best service and solution. Let us make a better world for our industry!



## Contact us

Tel: +86-755-8981 8866 Fax: +86-755-8427 6832

Email & Skype: info@chipsmall.com Web: www.chipsmall.com

Address: A1208, Overseas Decoration Building, #122 Zhenhua RD., Futian, Shenzhen, China



10 9 8 7 6 5 4 3 2 1

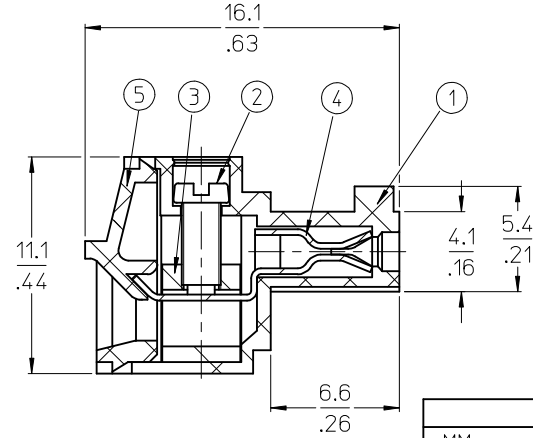
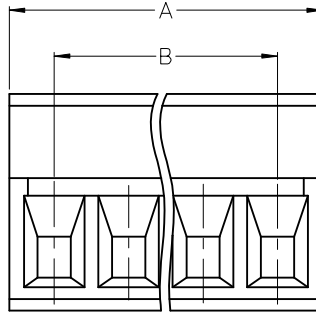
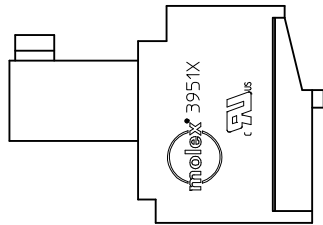
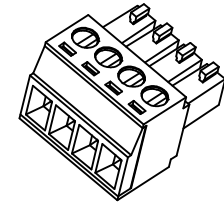
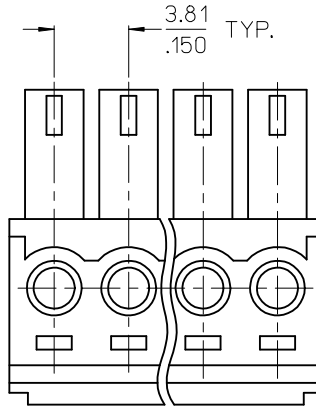

**SPECIFICATIONS:**

**1. MATERIAL:**

- (1). BODY: NYLON 66 (PA 66, UL94V-0).
- (2). SCREW: STEEL.
- (3). CAGE (\*): BRASS
- (4). TERMINAL: PHOSPHOR BRONZE (C)
- (5). COVER: NYLON 66 (PA 66, UL94V-0).

2. PRODUCT SPECIFICATION: PS-39500-001.

3. WIRE RANGE: 30 - 16AWG.

4. TORQUE: 2 in.-lbs.

5. WIRE STRIP LENGTH: 6.50/256.

6. NUMBER OF CIRCUIT POSITIONS AVAILABLE = 2 THROUGH 20.

7. ASSEMBLY IS ROHS COMPLIANT BY EXEMPTION.

COMPONENTS MARKED WITH AN ASTERISK (\*) ARE ROHS COMPLIANT BY EXEMPTION, ALL OTHERS ARE ROHS COMPLIANT.

TOLERANCES			
MM	TOL	INCH	TOL
0-6	±0.25	0-.24	±.010
>6-30	±0.40	.24-1.18	±.016
>30-120	±0.50	1.18-4.76	±.020
>120	±0.80	>4.76	±.031

REVISED DOC TOL EC NO: IPG2017-0881 DRAWN: ANAGATH 2017/03/23 CHKD: APPR: BRUPERT 2017/04/18 REV DESCRIPTION	QUALITY SYMBOLS	GENERAL TOLERANCES (UNLESS SPECIFIED)	DIMENSION STYLE	SCALE	DESIGN UNITS	THIRD ANGLE PROJECTION	
	▼=0 ▽=0	mm INCH 4 PLACES ±--- ±--- 3 PLACES ±--- ±--- 2 PLACES ±--- ±--- 1 PLACE ±--- ±--- ANGULAR ±---°	MM/IN	DRAWN BY DATE EHILE 2006/03/20 CHECKED BY DATE EHILE 2006/03/20 APPROVED BY DATE RDEROSS 2006/03/20	INCH	3.81MM, EURO PLUG, RIGHT ANGLE	Molex MOLEX INCORPORATED DOCUMENT NO. SD-39510-001 SHEET NO. 1 OF 2
		DRAFT WHERE APPLICABLE MUST REMAIN WITHIN DIMENSIONS	SEE CHART	THIS DRAWING CONTAINS INFORMATION THAT IS PROPRIETARY TO MOLEX INCORPORATED AND SHOULD NOT BE USED WITHOUT WRITTEN PERMISSION			

9 8 7 6 5 4 3 2 1

10 9 8 7 6 5 4 3 2 1

Circuit size	Material Numbers												Dimensional Information						
	Black						Green												
	100% Tin			30 u" Gold			100% Tin			30 u" Gold			Dim. A		Dim. B				
	Printing Options			Printing Options			Printing Options			Printing Options			mm	inch	mm	inch			
	None	10A	11A	None	10A	11A	None	10A	11A	None	10A	11A	None	10A	11A				
2	395100002	395100102	395100202	395100302	395100402	395100502	395100602	395100702	395100802	395100902	395101002	395101102	8.4	0.33	3.8	0.15			
3	395100003	395100103	395100203	395100303	395100403	395100503	395100603	395100703	395100803	395100903	395101003	395101103	12.2	0.48	7.6	0.30			
4	395100004	395100104	395100204	395100304	395100404	395100504	395100604	395100704	395100804	395100904	395101004	395101104	16.0	0.63	11.4	0.45			
5	395100005	395100105	395100205	395100305	395100405	395100505	395100605	395100705	395100805	395100905	395101005	395101105	19.8	0.78	15.2	0.60			
6	395100006	395100106	395100206	395100306	395100406	395100506	395100606	395100706	395100806	395100906	395101006	395101106	23.7	0.93	19.1	0.75			
7	395100007	395100107	395100207	395100307	395100407	395100507	395100607	395100707	395100807	395100907	395101007	395101107	27.5	1.08	22.9	0.90			
8	395100008	395100108	395100208	395100308	395100408	395100508	395100608	395100708	395100808	395100908	395101008	395101108	31.3	1.23	26.7	1.05			
9	395100009	395100109	395100209	395100309	395100409	395100509	395100609	395100709	395100809	395100909	395101009	395101109	35.1	1.38	30.5	1.20			
10	395100010	395100110	395100210	395100310	395100410	395100510	395100610	395100710	395100810	395100910	395101010	395101110	38.9	1.53	34.3	1.35			
11	395100011	395100111	395100211	395100311	395100411	395100511	395100611	395100711	395100811	395100911	395101011	395101111	42.7	1.68	38.1	1.50			
12	395100012	395100112	395100212	395100312	395100412	395100512	395100612	395100712	395100812	395100912	395101012	395101112	46.5	1.83	41.9	1.65			
13	395100013	395100113	395100213	395100313	395100413	395100513	395100613	395100713	395100813	395100913	395101013	395101113	50.3	1.98	45.7	1.80			
14	395100014	395100114	395100214	395100314	395100414	395100514	395100614	395100714	395100814	395100914	395101014	395101114	54.1	2.13	49.5	1.95			
15	395100015	395100115	395100215	395100315	395100415	395100515	395100615	395100715	395100815	395100915	395101015	395101115	57.9	2.28	53.3	2.10			
16	395100016	395100116	395100216	395100316	395100416	395100516	395100616	395100716	395100816	395100916	395101016	395101116	61.8	2.43	57.2	2.25			
17	395100017	395100117	395100217	395100317	395100417	395100517	395100617	395100717	395100817	395100917	395101017	395101117	65.6	2.58	61.0	2.40			
18	395100018	395100118	395100218	395100318	395100418	395100518	395100618	395100718	395100818	395100918	395101018	395101118	69.4	2.73	64.8	2.55			
19	395100019	395100119	395100219	395100319	395100419	395100519	395100619	395100719	395100819	395100919	395101019	395101119	73.2	2.88	68.6	2.70			
20	395100020	395100120	395100220	395100320	395100420	395100520	395100620	395100720	395100820	395100920	395101020	395101120	77.0	3.03	72.4	2.85			

2.0  
.08 TYP.  
CHARACTER  
HEIGHT

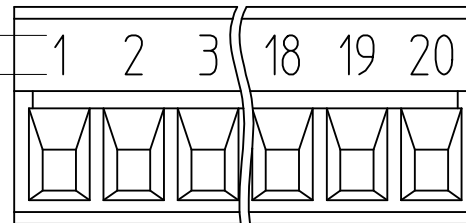

10A IMPRINTING

2.0  
.08 TYP.  
CHARACTER  
HEIGHT

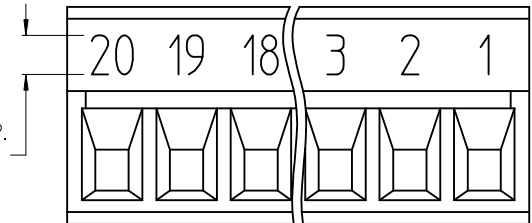

11A IMPRINTING

TOLERANCES			
MM	TOL	INCH	TOL
0-6	±0.25	0-.24	±.010
>6-30	±0.40	.24-1.18	±.016
>30-120	±0.50	1.18-4.76	±.020
>120	±0.80	>4.76	±.031

<b>REVISED DOC TOL</b> EC NO: IFC2017-0861 DRAWN: ANAGATH 2017/03/23 CHKD: [signature] APPR: BRUPERT 2017/04/18 REV	QUALITY SYMBOLS ▽=0 ▽=0	GENERAL TOLERANCES (UNLESS SPECIFIED) <table border="1"> <tr> <th></th> <th>mm</th> <th>INCH</th> </tr> <tr> <td>4 PLACES</td> <td>±---</td> <td>±---</td> </tr> <tr> <td>3 PLACES</td> <td>±---</td> <td>±---</td> </tr> <tr> <td>2 PLACES</td> <td>±---</td> <td>±---</td> </tr> <tr> <td>1 PLACE</td> <td>±---</td> <td>±---</td> </tr> </table>		mm	INCH	4 PLACES	±---	±---	3 PLACES	±---	±---	2 PLACES	±---	±---	1 PLACE	±---	±---	DIMENSION STYLE <b>MM/IN</b>	SCALE DESIGN UNITS <b>INCH</b>	THIRD ANGLE PROJECTION
		mm	INCH																	
	4 PLACES	±---	±---																	
	3 PLACES	±---	±---																	
2 PLACES	±---	±---																		
1 PLACE	±---	±---																		
DRAFT WHERE APPLICABLE MUST REMAIN WITHIN DIMENSIONS		DRAWN BY DATE EHILE 2006/03/20	TITLE <b>3.81MM, EURO PLUG, RIGHT ANGLE</b>																	
MATERIAL NO. <b>SEE CHART</b>		CHECKED BY DATE EHILE 2006/03/20	<b>MOLEX INCORPORATED</b>																	
SIZE <b>B</b>		APPROVED BY DATE RDEROSS 2006/03/20	DOCUMENT NO. <b>SD-39510-001</b>		SHEET NO. <b>2 OF 2</b>															

9 8 7 6 5 4 3 2 1