



Chipsmall Limited consists of a professional team with an average of over 10 year of expertise in the distribution of electronic components. Based in Hongkong, we have already established firm and mutual-benefit business relationships with customers from,Europe,America and south Asia,supplying obsolete and hard-to-find components to meet their specific needs.

With the principle of “Quality Parts,Customers Priority,Honest Operation,and Considerate Service”,our business mainly focus on the distribution of electronic components. Line cards we deal with include Microchip,ALPS,ROHM,Xilinx,Pulse,ON,Everlight and Freescale. Main products comprise IC,Modules,Potentiometer,IC Socket,Relay,Connector.Our parts cover such applications as commercial,industrial, and automotives areas.

We are looking forward to setting up business relationship with you and hope to provide you with the best service and solution. Let us make a better world for our industry!



## Contact us

Tel: +86-755-8981 8866 Fax: +86-755-8427 6832

Email & Skype: info@chipsmall.com Web: www.chipsmall.com

Address: A1208, Overseas Decoration Building, #122 Zhenhua RD., Futian, Shenzhen, China



3950X SERIES  
3.50mm HEADERS

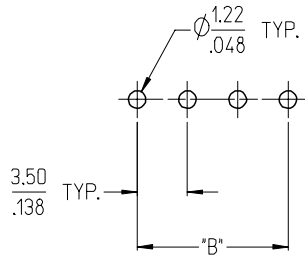

3952X & 3954X SERIES  
5.00mm HEADERS  
5.00mm 10 AMP FIXED

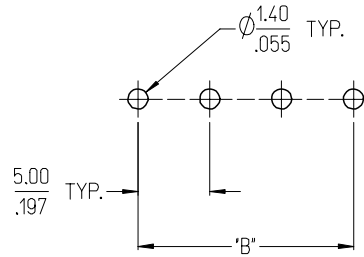

3953X SERIES  
5.08mm HEADERS

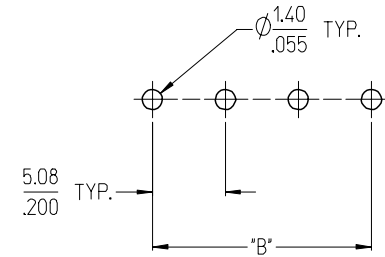

3951X SERIES  
3.81mm HEADERS

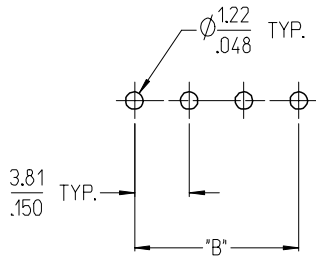

3954X SERIES  
5.00mm 15 AMP FIXED

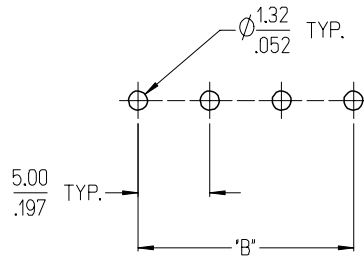

3954X SERIES  
5.08mm 15 AMP FIXED

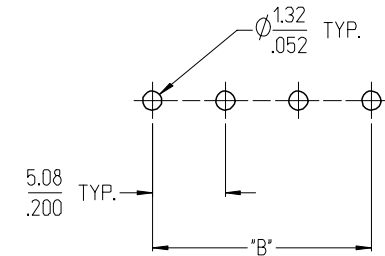

NOTES:

- REFER TO INDIVIDUAL PRODUCT SALES DRAWINGS FOR "B" DIMENSION.
- DOES NOT APPLY TO DUAL LEVEL HEADERS, SERIES 39528 AND 39538.
- TYP. = TYPICAL.

INITIAL RELEASE  
EC NO: ETC2007-0096  
DRW: CLYORK 2006/10/02  
CHKD: JMACNEIL 2006/10/04  
APPR: JMACNEIL 2006/10/04

REV	DESCRIPTION
A	QUALITY SYMBOLS ▽=0 ▽=0

GENERAL TOLERANCES (UNLESS SPECIFIED)	
	mm INCH
4 PLACES	± .005 ± .002
3 PLACES	± .005 ± .005
2 PLACES	± 0.13 ± .01
1 PLACE	± 0.3 ± .01
ANGULAR ± 2 °	
DRAFT WHERE APPLICABLE MUST REMAIN WITHIN DIMENSIONS	

DIMENSION STYLE	
MM/IN	
DRAWN BY	DATE
C. YORK	2006/08/25
CHECKED BY	DATE
J. MACNEIL	2006/08/25
APPROVED BY	DATE
J. MACNEIL	2006/08/25
MATERIAL NO.	---

SCALE	DESIGN UNITS	THIRD ANGLE PROJECTION
3:1	INCH	
TITLE		
RECOMMENDED PCB LAYOUT FOR ESE TERMINAL BLOCKS		
APPROVED BY		
J. MACNEIL		
DOCUMENT NO.		SHEET NO.
SD-39501-002		1 OF 1
MATERIAL NO.		
---		
SIZE		
B		
THIS DRAWING CONTAINS INFORMATION THAT IS PROPRIETARY TO MOLEX INCORPORATED AND SHOULD NOT BE USED WITHOUT WRITTEN PERMISSION		

10 9 8 7 6 5 4 3 2 1

F F

E E

D D

C C

B B

A A

9 8 7 6 5 4 3 2 1

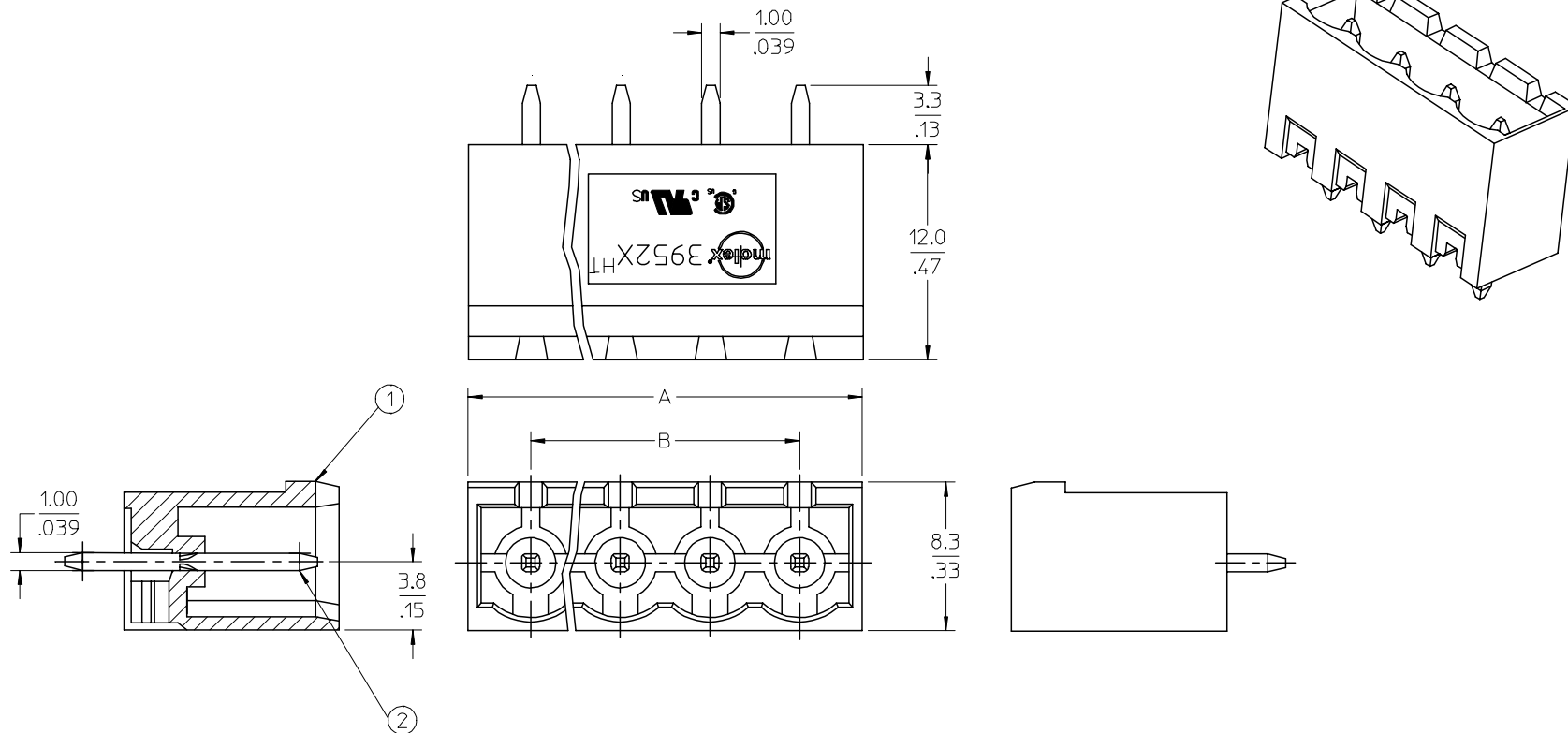

- SPECIFICATIONS:**
1. Material:
  - (1). Body: PA46
  - (2). Pin: Brass
  2. Wire range: N/A
  3. Electrical rating: 300V, 15A.
  4. Wire strip length: N/A
  5. Operating temperature: -40C to +140C.
  6. Max torque: N/A
  7. Insulation resistance: DC 500V, 500M.
  8. Dielectric withstand: AC 2500V for 1 minute.
  9. Breakdown voltage: 4000V.
  10. A = (N x P) + 2.0mm
  11. B = (N - 1) x P
  12. P (PITCH) = 5.0mm (.197")
  13. N = Number of positions available 2 through 24.

ENTER DESCRIPTION EC NO: NEO2006-0310 DRWNL: LROTHAUS 2006/01/09 CHKD: CYORK 2006/01/09 APPR: JPAWLICK 2006/01/10 DESCRIPTION REV A	QUALITY SYMBOLS ▽=0 ▽=0	GENERAL TOLERANCES (UNLESS SPECIFIED) <table border="1"> <thead> <tr> <th></th> <th>mm</th> <th>INCH</th> </tr> </thead> <tbody> <tr> <td>4 PLACES</td> <td>± ---</td> <td>± .0015</td> </tr> <tr> <td>3 PLACES</td> <td>± 0.038</td> <td>± .005</td> </tr> <tr> <td>2 PLACES</td> <td>± 0.13</td> <td>± .01</td> </tr> <tr> <td>1 PLACE</td> <td>± 0.3</td> <td>± ---</td> </tr> </tbody> </table> ANGULAR ± 2 °		mm	INCH	4 PLACES	± ---	± .0015	3 PLACES	± 0.038	± .005	2 PLACES	± 0.13	± .01	1 PLACE	± 0.3	± ---	DIMENSION STYLE MM/IN DRAWN BY: LROTHAUS DATE: 12/6/05 CHECKED BY: C. YORK DATE: 01/06/06 APPROVED BY: _____ DATE: _____	SCALE 4:1 DESIGN UNITS INCH THIRD ANGLE PROJECTION	TITLE 5.0MM, EURO HEADER, VERTICAL, HI-TEMP
		mm	INCH																	
	4 PLACES	± ---	± .0015																	
	3 PLACES	± 0.038	± .005																	
2 PLACES	± 0.13	± .01																		
1 PLACE	± 0.3	± ---																		
		MATERIAL NO. SEE CHART	DOCUMENT NO. SD-39521-001	SHEET NO. 1 OF 1																
		DRAFT WHERE APPLICABLE MUST REMAIN WITHIN DIMENSIONS	MOLEX INCORPORATED																	
		THIS DRAWING CONTAINS INFORMATION THAT IS PROPRIETARY TO MOLEX INCORPORATED AND SHOULD NOT BE USED WITHOUT WRITTEN PERMISSION																		

Description	Circuit size	Material Numbers											Dimensional Information				
		Black						Green					Dim. A		Dim B		
		100% Tin			30 u" Gold			100% Tin			30 u" Gold		mm	inch	mm	inch	
		Printing Options			Printing Options			Printing Options			Printing Options						
None	10AV	11AV	None	10AV	11AV	None	10AV	11AV	None	10AV	11AV						
5.0mm, Euro Header, Vertical, High Temp	2	395214002	395214302	395214402	395214502	395214802	395214902	395219002	395219302	395219402	395219502	395219802	395219902	12.00	0.472	5.00	0.197
5.0mm, Euro Header, Vertical, High Temp	3	395214003	395214303	395214403	395214503	395214803	395214903	395219003	395219303	395219403	395219503	395219803	395219903	17.00	0.669	10.00	0.394
5.0mm, Euro Header, Vertical, High Temp	4	395214004	395214304	395214404	395214504	395214804	395214904	395219004	395219304	395219404	395219504	395219804	395219904	22.00	0.866	15.00	0.591
5.0mm, Euro Header, Vertical, High Temp	5	395214005	395214305	395214405	395214505	395214805	395214905	395219005	395219305	395219405	395219505	395219805	395219905	27.00	1.063	20.00	0.787
5.0mm, Euro Header, Vertical, High Temp	6	395214006	395214306	395214406	395214506	395214806	395214906	395219006	395219306	395219406	395219506	395219806	395219906	32.00	1.260	25.00	0.984
5.0mm, Euro Header, Vertical, High Temp	7	395214007	395214307	395214407	395214507	395214807	395214907	395219007	395219307	395219407	395219507	395219807	395219907	37.00	1.457	30.00	1.181
5.0mm, Euro Header, Vertical, High Temp	8	395214008	395214308	395214408	395214508	395214808	395214908	395219008	395219308	395219408	395219508	395219808	395219908	42.00	1.654	35.00	1.378
5.0mm, Euro Header, Vertical, High Temp	9	395214009	395214309	395214409	395214509	395214809	395214909	395219009	395219309	395219409	395219509	395219809	395219909	47.00	1.850	40.00	1.575
5.0mm, Euro Header, Vertical, High Temp	10	395214010	395214310	395214410	395214510	395214810	395214910	395219010	395219310	395219410	395219510	395219810	395219910	52.00	2.047	45.00	1.772
5.0mm, Euro Header, Vertical, High Temp	11	395214011	395214311	395214411	395214511	395214811	395214911	395219011	395219311	395219411	395219511	395219811	395219911	57.00	2.244	50.00	1.969
5.0mm, Euro Header, Vertical, High Temp	12	395214012	395214312	395214412	395214512	395214812	395214912	395219012	395219312	395219412	395219512	395219812	395219912	62.00	2.441	55.00	2.165
5.0mm, Euro Header, Vertical, High Temp	13	395214013	395214313	395214413	395214513	395214813	395214913	395219013	395219313	395219413	395219513	395219813	395219913	67.00	2.638	60.00	2.362
5.0mm, Euro Header, Vertical, High Temp	14	395214014	395214314	395214414	395214514	395214814	395214914	395219014	395219314	395219414	395219514	395219814	395219914	72.00	2.835	65.00	2.559
5.0mm, Euro Header, Vertical, High Temp	15	395214015	395214315	395214415	395214515	395214815	395214915	395219015	395219315	395219415	395219515	395219815	395219915	77.00	3.031	70.00	2.756
5.0mm, Euro Header, Vertical, High Temp	16	395214016	395214316	395214416	395214516	395214816	395214916	395219016	395219316	395219416	395219516	395219816	395219916	82.00	3.228	75.00	2.953
5.0mm, Euro Header, Vertical, High Temp	17	395214017	395214317	395214417	395214517	395214817	395214917	395219017	395219317	395219417	395219517	395219817	395219917	87.00	3.425	80.00	3.150
5.0mm, Euro Header, Vertical, High Temp	18	395214018	395214318	395214418	395214518	395214818	395214918	395219018	395219318	395219418	395219518	395219818	395219918	92.00	3.622	85.00	3.346
5.0mm, Euro Header, Vertical, High Temp	19	395214019	395214319	395214419	395214519	395214819	395214919	395219019	395219319	395219419	395219519	395219819	395219919	97.00	3.819	90.00	3.543
5.0mm, Euro Header, Vertical, High Temp	20	395214020	395214320	395214420	395214520	395214820	395214920	395219020	395219320	395219420	395219520	395219820	395219920	102.00	4.016	95.00	3.740
5.0mm, Euro Header, Vertical, High Temp	21	395214021	395214321	395214421	395214521	395214821	395214921	395219021	395219321	395219421	395219521	395219821	395219921	107.00	4.213	100.00	3.937
5.0mm, Euro Header, Vertical, High Temp	22	395214022	395214322	395214422	395214522	395214822	395214922	395219022	395219322	395219422	395219522	395219822	395219922	112.00	4.409	105.00	4.134
5.0mm, Euro Header, Vertical, High Temp	23	395214023	395214323	395214423	395214523	395214823	395214923	395219023	395219323	395219423	395219523	395219823	395219923	117.00	4.606	110.00	4.331
5.0mm, Euro Header, Vertical, High Temp	24	395214024	395214324	395214424	395214524	395214824	395214924	395219024	395219324	395219424	395219524	395219824	395219924	122.00	4.803	115.00	4.528

SEE SHEET 1 EC NO: NEC2006-0310 DRWN: LROTHAUS 2006/01/09 CHKD: CYORK 2006/01/09 APPR: JPAWLICK 2006/01/10	QUALITY SYMBOLS ▽=0 ▽=0	GENERAL TOLERANCES (UNLESS SPECIFIED) mm INCH 4 PLACES ± --- ±.0015 3 PLACES ±0.038 ±.005 2 PLACES ±0.13 ±.01 1 PLACE ±0.3 ± --- ANGULAR ± 2 °	DIMENSION STYLE IN/MM DRAWN BY DATE LROTHAUS 12/1/05 CHECKED BY DATE C. YORK 01/06/06 APPROVED BY DATE	SCALE 4:1 DESIGN UNITS INCH THIRD ANGLE PROJECTION	TITLE 5.0MM, EURO HEADER VERTICAL, HI-TEMP	
	MATERIAL NO. SEE CHART	DOCUMENT NO. SD-39521-001	SHEET NO. 2 OF 2			
	DRAFT WHERE APPLICABLE MUST REMAIN WITHIN DIMENSIONS			MOLEX INCORPORATED		
	THIS DRAWING CONTAINS INFORMATION THAT IS PROPRIETARY TO MOLEX INCORPORATED AND SHOULD NOT BE USED WITHOUT WRITTEN PERMISSION					