



Chipsmall Limited consists of a professional team with an average of over 10 year of expertise in the distribution of electronic components. Based in Hongkong, we have already established firm and mutual-benefit business relationships with customers from,Europe,America and south Asia,supplying obsolete and hard-to-find components to meet their specific needs.

With the principle of "Quality Parts,Customers Priority,Honest Operation,and Considerate Service",our business mainly focus on the distribution of electronic components. Line cards we deal with include Microchip,ALPS,ROHM,Xilinx,Pulse,ON,Everlight and Freescale. Main products comprise IC,Modules,Potentiometer,IC Socket,Relay,Connector.Our parts cover such applications as commercial,industrial, and automotives areas.

We are looking forward to setting up business relationship with you and hope to provide you with the best service and solution. Let us make a better world for our industry!



Contact us

Tel: +86-755-8981 8866 Fax: +86-755-8427 6832

Email & Skype: info@chipsmall.com Web: www.chipsmall.com

Address: A1208, Overseas Decoration Building, #122 Zhenhua RD., Futian, Shenzhen, China



3950X SERIES
3.50mm HEADERS

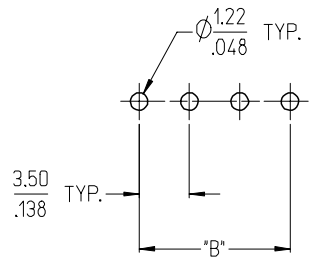

3952X & 3954X SERIES
5.00mm HEADERS
5.00mm 10 AMP FIXED

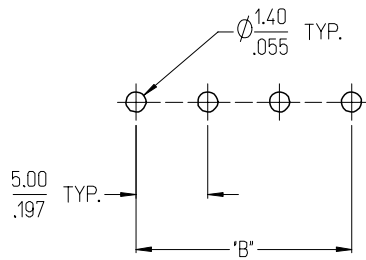

3953X SERIES
5.08mm HEADERS

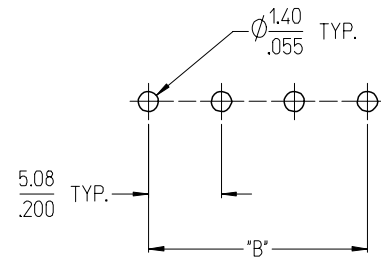

3951X SERIES
3.81mm HEADERS

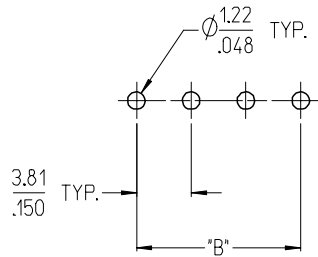

3954X SERIES
5.00mm 15 AMP FIXED

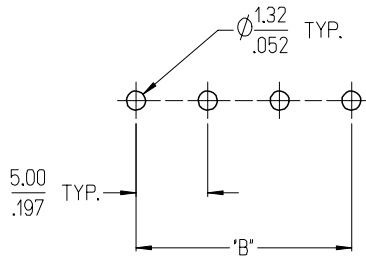

3954X SERIES
5.08mm 15 AMP FIXED

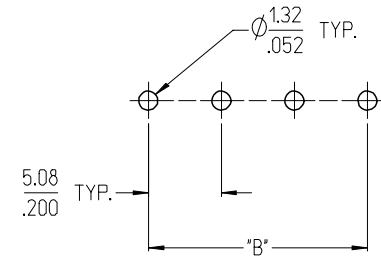

NOTES:

- REFER TO INDIVIDUAL PRODUCT SALES DRAWINGS FOR "B" DIMENSION.
- DOES NOT APPLY TO DUAL LEVEL HEADERS, SERIES 39528 AND 39538.
- TYP. = TYPICAL.

INITIAL RELEASE
EC NO: ETC2007-0096
DRAWN: CLYORK 2006/10/02
CHKD: JMACNEIL 2006/10/04
APPR: JMACNEIL 2006/10/04

REV	DESCRIPTION
A	

	QUALITY SYMBOLS	
	mm	INCH
4 PLACES	± .005	± .005
3 PLACES	± .010	± .005
2 PLACES	± 0.13	± .01
1 PLACE	± 0.3	± .01
ANGULAR ± 2 °		

GENERAL TOLERANCES (UNLESS SPECIFIED)	
DRAWN BY	DATE
C. YORK	2006/08/25
CHECKED BY	DATE
J. MACNEIL	2006/08/25
APPROVED BY	DATE
J. MACNEIL	2006/08/25
MATERIAL NO.	
--	

DIMENSION STYLE	SCALE	DESIGN UNITS	THIRD ANGLE PROJECTION
MM/IN	3:1	INCH	
TITLE			
RECOMMENDED PCB LAYOUT FOR ESE TERMINAL BLOCKS			
APPROVED BY			
J. MACNEIL 2006/08/25			
MATERIAL NO.			
--			
DOCUMENT NO.			SHEET NO.
SD-39501-002			1 OF 1

10 9 8 7 6 5 4 3 2 1

F

E

D

C

B

A

F

E

D

C

B

A

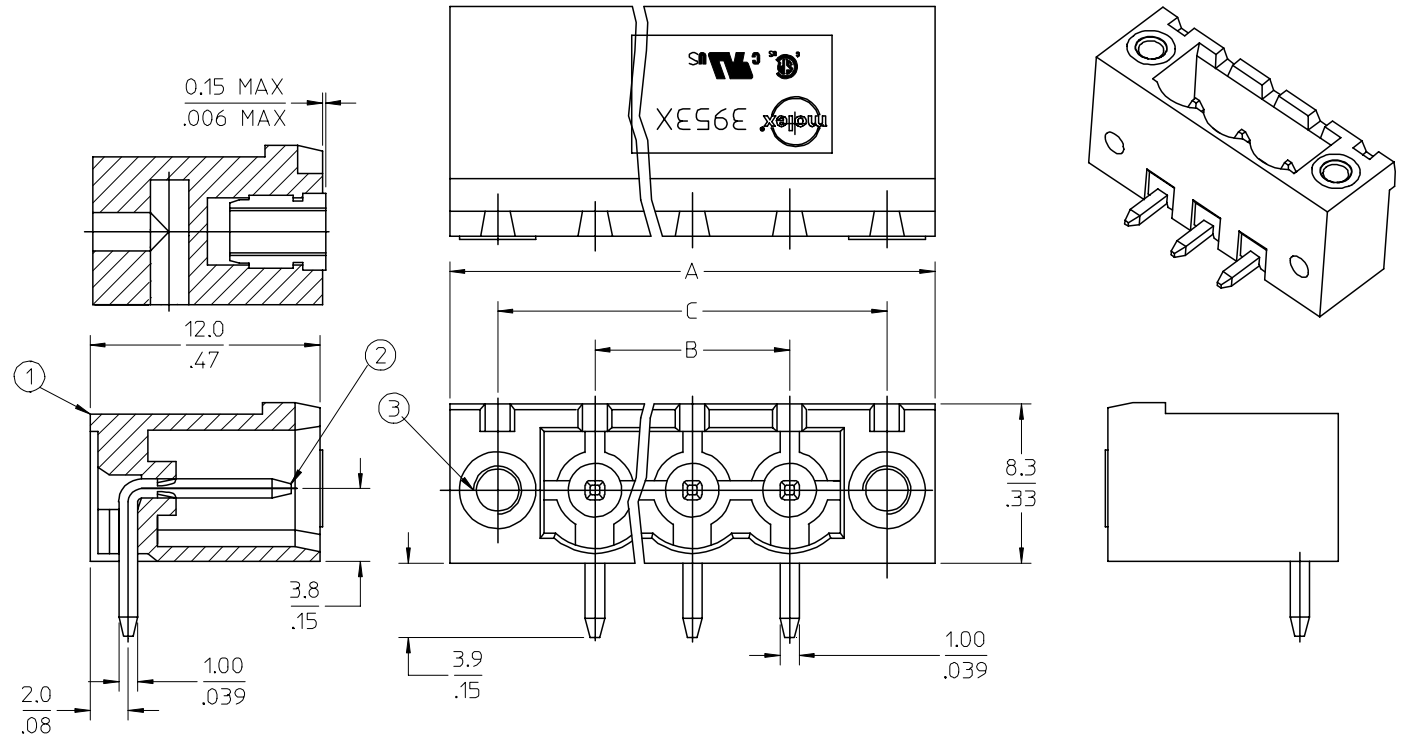

SPECIFICATIONS:

1. Material:

- (1). Body: PA66
- (2). Pin: Brass
- (3). Threaded insert: Brass

2. Wire range: N/A

3. Electrical rating: 300V, 15A.

4. Wire strip length: N/A

5. Operating temperature: -40C to +105C.

6. Max torque: N/A

7. Insulation resistance: DC 500V, 500M.

8. Dielectric withstand: AC 2500V for 1 minute.

9. Breakdown voltage: 4000V.

10. A = (B + 15.24mm)

11. B = (N - 1) x P

13. C = (B + 10.16mm)

12. P (PITCH) = 5.08mm (.200").

13. N = Number of positions available 2 through 24.

ENTER DESCRIPTION EC NO: NEO2006-0310 DRWN: LROTHAUS 2006/01/09 CHKD: CYORK 2006/01/09 APPR: JPAMLIK 2006/01/10	DESCRIPTION QUALITY SYMBOLS ▽=0 ▽=0	GENERAL TOLERANCES (UNLESS SPECIFIED)		DIMENSION STYLE MM/IN		SCALE 4:1	DESIGN UNITS INCH	THIRD ANGLE PROJECTION
		4 PLACES ± --- ±.0015	DRAWN BY LROTHAUS	DATE 12/6/05	TITLE 5.08MM, EURO HEADER, RIGHT ANGLE, MOUNTING			
		3 PLACES ±0.038 ±.005	CHECKED BY C. YORK	DATE 01/06/06	MOLEX INCORPORATED			
		2 PLACES ±0.13 ±.01	APPROVED BY	DATE	MATERIAL NO. SEE CHART	DOCUMENT NO. SD-39536-002	SHEET NO. 1 OF 1	
1 PLACE ±0.3 ± ---	ANGULAR ± 2 °		THIS DRAWING CONTAINS INFORMATION THAT IS PROPRIETARY TO MOLEX INCORPORATED AND SHOULD NOT BE USED WITHOUT WRITTEN PERMISSION					
DRAFT WHERE APPLICABLE MUST REMAIN WITHIN DIMENSIONS								

9 8 7 6 5 4 3 2 1

Description	Circuit size	Material Numbers												Dimensional Information					
		Black						Green						Dim. A		Dim. B		Dim. C	
		100% Tin			30 u" Gold			100% Tin			30 u" Gold			mm	inch	mm	inch	mm	inch
		Printing Options			Printing Options			Printing Options			Printing Options								
		None	10A	11A	None	10A	11A	None	10A	11A	None	10A	11A						
5.08mm, Euro Header, Right Angle, Mounting Ends	2	395360002	395360102	395360202	395360502	395360602	395360702	395365002	395365102	395365202	395365502	395365602	395365702	20.32	0.800	5.08	0.200	15.24	0.600
5.08mm, Euro Header, Right Angle, Mounting Ends	3	395360003	395360103	395360203	395360503	395360603	395360703	395365003	395365103	395365203	395365503	395365603	395365703	25.40	1.000	10.16	0.400	20.32	0.800
5.08mm, Euro Header, Right Angle, Mounting Ends	4	395360004	395360104	395360204	395360504	395360604	395360704	395365004	395365104	395365204	395365504	395365604	395365704	30.48	1.200	15.24	0.600	25.40	1.000
5.08mm, Euro Header, Right Angle, Mounting Ends	5	395360005	395360105	395360205	395360505	395360605	395360705	395365005	395365105	395365205	395365505	395365605	395365705	35.56	1.400	20.32	0.800	30.48	1.200
5.08mm, Euro Header, Right Angle, Mounting Ends	6	395360006	395360106	395360206	395360506	395360606	395360706	395365006	395365106	395365206	395365506	395365606	395365706	40.64	1.600	25.40	1.000	35.56	1.400
5.08mm, Euro Header, Right Angle, Mounting Ends	7	395360007	395360107	395360207	395360507	395360607	395360707	395365007	395365107	395365207	395365507	395365607	395365707	45.72	1.800	30.48	1.200	40.64	1.600
5.08mm, Euro Header, Right Angle, Mounting Ends	8	395360008	395360108	395360208	395360508	395360608	395360708	395365008	395365108	395365208	395365508	395365608	395365708	50.80	2.000	35.56	1.400	45.72	1.800
5.08mm, Euro Header, Right Angle, Mounting Ends	9	395360009	395360109	395360209	395360509	395360609	395360709	395365009	395365109	395365209	395365509	395365609	395365709	55.88	2.200	40.64	1.600	50.80	2.000
5.08mm, Euro Header, Right Angle, Mounting Ends	10	395360010	395360110	395360210	395360510	395360610	395360710	395365010	395365110	395365210	395365510	395365610	395365710	60.96	2.400	45.72	1.700	55.88	2.200
5.08mm, Euro Header, Right Angle, Mounting Ends	11	395360011	395360111	395360211	395360511	395360611	395360711	395365011	395365111	395365211	395365511	395365611	395365711	66.04	2.600	50.80	2.000	60.96	2.400
5.08mm, Euro Header, Right Angle, Mounting Ends	12	395360012	395360112	395360212	395360512	395360612	395360712	395365012	395365112	395365212	395365512	395365612	395365712	71.12	2.800	55.88	2.200	66.04	2.600
5.08mm, Euro Header, Right Angle, Mounting Ends	13	395360013	395360113	395360213	395360513	395360613	395360713	395365013	395365113	395365213	395365513	395365613	395365713	76.20	3.000	60.96	2.400	71.12	2.800
5.08mm, Euro Header, Right Angle, Mounting Ends	14	395360014	395360114	395360214	395360514	395360614	395360714	395365014	395365114	395365214	395365514	395365614	395365714	81.28	3.200	66.04	2.600	76.20	3.000
5.08mm, Euro Header, Right Angle, Mounting Ends	15	395360015	395360115	395360215	395360515	395360615	395360715	395365015	395365115	395365215	395365515	395365615	395365715	86.36	3.400	71.12	2.800	81.28	3.200
5.08mm, Euro Header, Right Angle, Mounting Ends	16	395360016	395360116	395360216	395360516	395360616	395360716	395365016	395365116	395365216	395365516	395365616	395365716	91.44	3.600	76.20	3.000	86.36	3.400
5.08mm, Euro Header, Right Angle, Mounting Ends	17	395360017	395360117	395360217	395360517	395360617	395360717	395365017	395365117	395365217	395365517	395365617	395365717	96.52	3.800	81.28	3.200	91.44	3.600
5.08mm, Euro Header, Right Angle, Mounting Ends	18	395360018	395360118	395360218	395360518	395360618	395360718	395365018	395365118	395365218	395365518	395365618	395365718	101.60	4.000	86.36	3.400	96.52	3.800
5.08mm, Euro Header, Right Angle, Mounting Ends	19	395360019	395360119	395360219	395360519	395360619	395360719	395365019	395365119	395365219	395365519	395365619	395365719	106.68	4.200	91.44	3.600	101.60	4.000
5.08mm, Euro Header, Right Angle, Mounting Ends	20	395360020	395360120	395360220	395360520	395360620	395360720	395365020	395365120	395365220	395365520	395365620	395365720	111.76	4.400	96.52	3.800	106.68	4.200
5.08mm, Euro Header, Right Angle, Mounting Ends	21	395360021	395360121	395360221	395360521	395360621	395360721	395365021	395365121	395365221	395365521	395365621	395365721	116.84	4.600	101.60	4.000	111.76	4.400
5.08mm, Euro Header, Right Angle, Mounting Ends	22	395360022	395360122	395360222	395360522	395360622	395360722	395365022	395365122	395365222	395365522	395365622	395365722	121.92	4.800	106.68	4.200	116.84	4.600
5.08mm, Euro Header, Right Angle, Mounting Ends	23	395360023	395360123	395360223	395360523	395360623	395360723	395365023	395365123	395365223	395365523	395365623	395365723	127.00	5.000	111.76	4.400	121.92	4.800
5.08mm, Euro Header, Right Angle, Mounting Ends	24	395360024	395360124	395360224	395360524	395360624	395360724	395365024	395365124	395365224	395365524	395365624	395365724	132.08	5.200	116.84	4.600	127.00	5.000

SEE SHEET 1 EC NO: NEC2006-0310 DRWN: LROTHAUS 2006/01/09 CHKD: CYORK 2006/01/09 APPR: J.PAWLIK 2006/01/10	QUALITY SYMBOLS ▽=0 ▽=0	GENERAL TOLERANCES (UNLESS SPECIFIED)		DIMENSION STYLE MM/IN		SCALE 4:1	DESIGN UNITS INCH	THIRD ANGLE PROJECTION
		4 PLACES ± --- ±.0015	3 PLACES ± 0.038 ±.005	DRAWN BY LROTHAUS	DATE 12/6/05	TITLE 5.08MM, EURO HEADER, RIGHT ANGLE, MOUNTING		
		2 PLACES ± 0.13 ±.01	1 PLACE ± 0.3 ± ---	CHECKED BY C. YORK	DATE 01/05/06			
		ANGULAR ± 2 °		APPROVED BY	DATE	MOLEX INCORPORATED		
DRAFT WHERE APPLICABLE MUST REMAIN WITHIN DIMENSIONS	MATERIAL NO. SEE CHART	DOCUMENT NO. SD-39536-002		SHEET NO. 2 OF 2				
THIS DRAWING CONTAINS INFORMATION THAT IS PROPRIETARY TO MOLEX INCORPORATED AND SHOULD NOT BE USED WITHOUT WRITTEN PERMISSION								