



Chipsmall Limited consists of a professional team with an average of over 10 year of expertise in the distribution of electronic components. Based in Hongkong, we have already established firm and mutual-benefit business relationships with customers from,Europe,America and south Asia,supplying obsolete and hard-to-find components to meet their specific needs.

With the principle of “Quality Parts,Customers Priority,Honest Operation,and Considerate Service”,our business mainly focus on the distribution of electronic components. Line cards we deal with include Microchip,ALPS,ROHM,Xilinx,Pulse,ON,Everlight and Freescale. Main products comprise IC,Modules,Potentiometer,IC Socket,Relay,Connector.Our parts cover such applications as commercial,industrial, and automotives areas.

We are looking forward to setting up business relationship with you and hope to provide you with the best service and solution. Let us make a better world for our industry!



Contact us

Tel: +86-755-8981 8866 Fax: +86-755-8427 6832

Email & Skype: info@chipsmall.com Web: www.chipsmall.com

Address: A1208, Overseas Decoration Building, #122 Zhenhua RD., Futian, Shenzhen, China



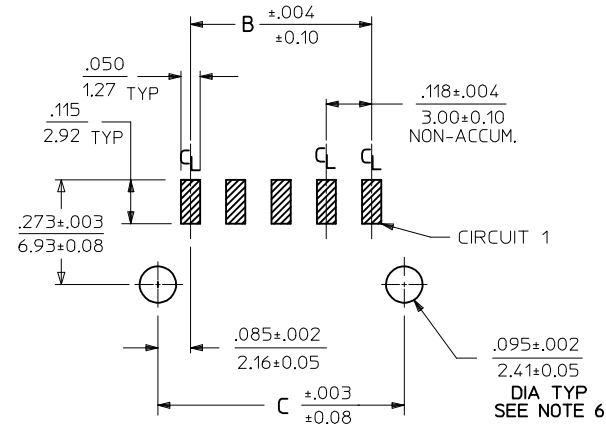
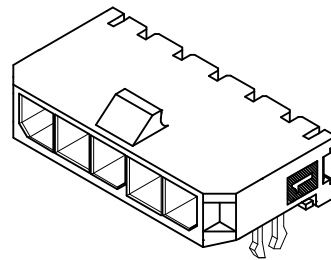
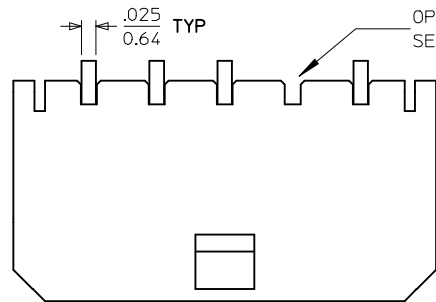

PCB LAYOUT: COMPONENT SIDE
RECOMMENDED PCB THICKNESS: .062/1.57

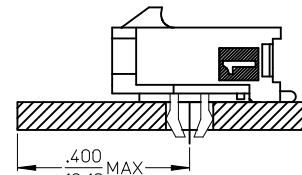
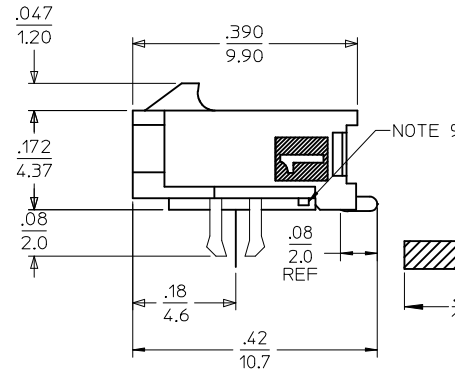
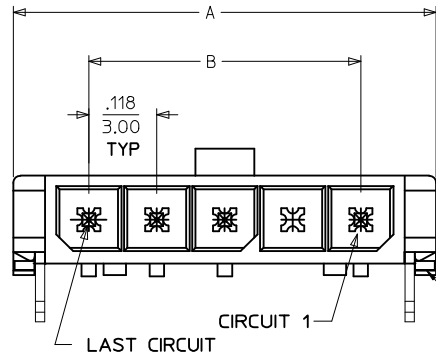

LOCATION DETAIL
SEE NOTE #8

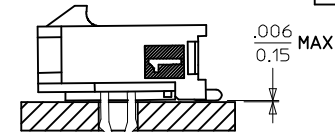

COPLANARITY DETAIL
SEE NOTE #7

CKTS	DIM A	DIM B	DIM C
2	.380 9.65	.118 3.00	.287 7.30
3	.498 12.65	.236 6.00	.405 10.30
4	.616 15.65	.354 9.00	.524 13.30
5	.734 18.64	.472 12.00	.642 16.30
6	.852 21.64	.591 15.00	.760 19.30
7	.970 24.64	.709 18.00	.878 22.30
8	1.088 27.64	.827 21.00	.996 25.30
9	1.206 30.63	.945 24.00	1.114 28.30
10	1.325 33.66	1.063 27.00	1.232 31.30
11	1.443 36.65	1.181 30.00	1.350 34.30
12	1.561 39.65	1.299 33.00	1.469 37.30

- NOTES:
- HOUSING MATERIAL: LIQUID CRYSTAL POLYMER, GLASS FILLED, UL94V-0, COLOR: BLACK
TERMINAL MATERIAL: BRASS ALLOY
 - FINISH:
 - A = .000060/(0.00152) MIN. REFLOWED MATTE TIN OVER
.000050/(0.00127) MIN. NICKEL
(FINISH IS BRIGHT IN APPEARANCE, THICKNESS AS APPLIED PRIOR TO REFLOW)
 - B = .000015/(0.00038) MIN. SELECT GOLD IN CONTACT AREA
.000100/(0.00254) MIN. SELECT MATTE TIN ON SOLDER TAILS
BOTH OVER .000050/(0.00127) NICKEL OVERALL
 - C = .000030/(0.00076) MIN. SELECT GOLD IN CONTACT AREA
.000100/(0.00254) MIN. SELECT MATTE TIN ON SOLDER TAILS
BOTH OVER .000050/(0.00127) NICKEL OVERALL
 - PRODUCT SPECIFICATION: PS-43650
 - TAPE AND REEL PACKAGED : SEE MOLEX DRAWING PK-70873-07**
 - MATES WITH: RECEPTACLE NUMBER 43645
 - TO MINIMIZE INSERTION FORCE ON MOUNTING CLIPS DURING ROBOTIC PLACEMENT, HOLE DIAMETER SPECIFICATIONS MUST BE INCREASED MAKING THEM MORE COMPATIBLE WITH PICK AND PLACE EQUIPMENT. HOLE DIAMETERS SHOULD BE INCREASED TO APPROXIMATELY .100±.002/(2.54±0.05) AND EVALUATED PER PLACEMENT EQUIPMENT.
 - THE COPLANARITY DIMENSION IS ESTABLISHED BY PLACING THE ASSEMBLY ON A FLAT SURFACE. THE DISTANCE FROM THAT SURFACE TO THE BOTTOM OF ANY ANY TERMINAL MUST NOT EXCEED .006/0.15
 - TO AVOID INTERFERENCE BETWEEN RECEPTACLE AND PCB, HEADER MUST BE PLACED WITHIN .400/(10.16) MAX. FROM EDGE OF PCB, AS SHOWN IN LOCATION DETAIL.
 - METAL TAB MAY BE FLUSH WITH PCB.
 - PARTS CONFORM TO CLASS 'B' REQUIREMENTS OF COSMETIC SPECIFICATION PS-45499-002.

CKTS	FINISH A		FINISH B		FINISH C	
	MATERIAL NO:	VOID CKT	MATERIAL NO:	VOID CKT	MATERIAL NO:	VOID CKT
02	43650-0209		43650-0210		43650-0211	
03	43650-0309		43650-0310		43650-0311	
04	43650-0409		43650-0410		43650-0411	
05	43650-0509		43650-0510		43650-0511	
06	43650-0609		43650-0610		43650-0611	
07	43650-0709		43650-0710		43650-0711	
08	43650-0809		43650-0810		43650-0811	
09	43650-0909		43650-0910		43650-0911	
10	43650-1009		43650-1010		43650-1011	
11	43650-1109		43650-1110		43650-1111	
12	43650-1209		43650-1210		43650-1211	
03					43650-1311	02
04			43650-1410	02		

RECEPTACLE #43645

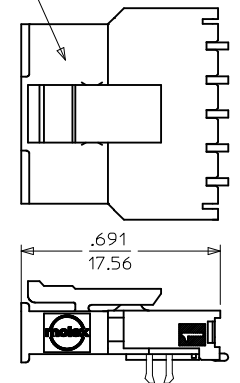

MATED MICRO FIT CONNECTORS

REVISE FINISH A EC NO: UCP2016-2946 DRWING: BAPPELDORN CHKD: JDOX APPR: FSMITH 2016/01/28 2016/03/18	QUALITY SYMBOLS	GENERAL TOLERANCES (UNLESS SPECIFIED)	DIMENSION STYLE	SCALE	DESIGN UNITS	THIRD ANGLE PROJECTION
	▽=0	mm INCH	IN/MM	---	METRIC	
	▽=0	4 PLACES ± --- ± ---	DRAWN BY DATE	TITLE		
	▽=0	3 PLACES ± --- ± .010	SAMIEC 2000/07/07	MICRO FIT (3.0) SINGLE ROW / RIGHT ANGLE SMT / CLIPS / REEL		
		2 PLACES ± 0.25 ± .014	CHECKED BY DATE			
		1 PLACE ± 0.36 ± ---	MUELLER 2000/07/07			
		0 PLACE ± --- ± ---	APPROVED BY DATE			
		ANGULAR ±1/2°	FSMITH 2016/03/18			
		DRAFT WHERE APPLICABLE MUST REMAIN WITHIN DIMENSIONS	MATERIAL NO.	DOCUMENT NO.		
			SEE CHART	SD-43650-004		
			THIS DRAWING CONTAINS INFORMATION THAT IS PROPRIETARY TO MOLEX INCORPORATED AND SHOULD NOT BE USED WITHOUT WRITTEN PERMISSION			