



Chipsmall Limited consists of a professional team with an average of over 10 year of expertise in the distribution of electronic components. Based in Hongkong, we have already established firm and mutual-benefit business relationships with customers from,Europe,America and south Asia,supplying obsolete and hard-to-find components to meet their specific needs.

With the principle of “Quality Parts,Customers Priority,Honest Operation,and Considerate Service”,our business mainly focus on the distribution of electronic components. Line cards we deal with include Microchip,ALPS,ROHM,Xilinx,Pulse,ON,Everlight and Freescale. Main products comprise IC,Modules,Potentiometer,IC Socket,Relay,Connector.Our parts cover such applications as commercial,industrial, and automotives areas.

We are looking forward to setting up business relationship with you and hope to provide you with the best service and solution. Let us make a better world for our industry!



Contact us

Tel: +86-755-8981 8866 Fax: +86-755-8427 6832

Email & Skype: info@chipsmall.com Web: www.chipsmall.com

Address: A1208, Overseas Decoration Building, #122 Zhenhua RD., Futian, Shenzhen, China



RPC-N
50 Ω

Attenuator
Plug/Jack

05AS102-K10S3

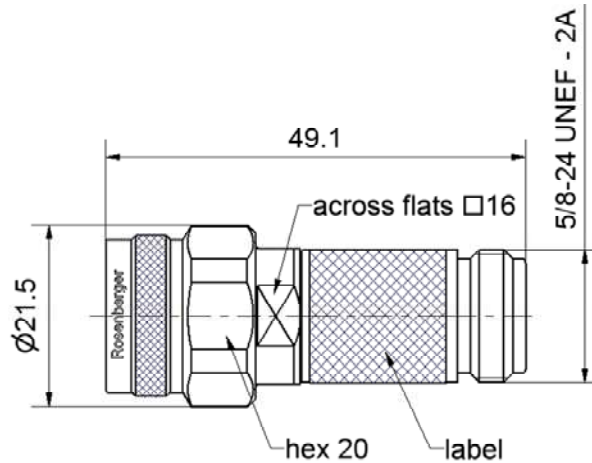

All dimensions are in mm; tolerances according to ISO 2768 m-H

Interface

According to

IEC 61169-16 ; CECC 22 210 ; MIL-STD 348A/402

Documents

N/A

Material and plating

Connector parts

- Center conductor - plug
- Center conductor - jack
- Outer conductor
- Coupling nut
- Dielectric
- Substrate

Material

- Brass
- Beryllium copper
- Stainless steel
- Stainless steel
- PPE
- Al₂O₃

Plating

- Gold, min. 1.27 μm, over nickel
- Gold, min. 1.27 μm, over nickel
- Passivated
- Passivated

Dieses Dokument ist urheberrechtlich geschützt • This document is protected by copyright • Rosenberger Hochfrequenztechnik GmbH & Co. KG

RF_35/05.10/6.0

RPC-N
50 Ω Attenuator
Plug/Jack

05AS102-K10S3

Electrical data

Impedance 50 Ω
 Frequency range DC to 18 GHz
 Return loss ≥ 26.4 dB, DC to 4 GHz
 ≥ 23.1 dB, 4 GHz to 12.4 GHz
 ≥ 19.1 dB, 12.4 GHz to 18 GHz
 Attenuation 10 dB ± 0.3 dB, DC to 8 GHz
 10 dB ± 0.6 dB, 8 GHz to 12.4 GHz
 10 dB ± 0.8 dB, 12.4 GHz to 18 GHz
 Power handling 2 W at 25 °C

Mechanical data

Mating cycles ≥ 500
 Maximum torque 1.70 Nm
 Recommended torque 1.10 Nm
 Gauge - plug 5.28 mm to 5.36 mm
 Gauge - jack 5.18 mm to 5.26 mm

Environmental data

Operating temperature range¹ 0 °C to +50 °C
 Storage temperature range -40 °C to +85 °C
 2002/95/EC (RoHS) compliant

¹ Temperature range over which these specifications are valid.

Packing

Standard 1 pce in box
 Weight 59.0 g/pce

While the information has been carefully compiled to the best of our knowledge, nothing is intended as representation or warranty on our part and no statement herein shall be construed as recommendation to infringe existing patents. In the effort to improve our products, we reserve the right to make changes judged to be necessary.

Draft	Date	Approved	Date	Rev.	Engineering change number	Name	Date
Kerstin Herzog	06/01/05	Frank Weiß	24/01/12	e00	11-0832	Marion Striegler	19/01/12
Rosenberger Hochfrequenztechnik GmbH & Co. KG P.O.Box 1260 D-84526 Tittmoning Germany www.rosenberger.de					Tel. : +49 8684 18-0 Fax : +49 8684 18-499 Email : info@rosenberger.de		Page 2 / 2