



Chipsmall Limited consists of a professional team with an average of over 10 year of expertise in the distribution of electronic components. Based in Hongkong, we have already established firm and mutual-benefit business relationships with customers from,Europe,America and south Asia,supplying obsolete and hard-to-find components to meet their specific needs.

With the principle of "Quality Parts,Customers Priority,Honest Operation,and Considerate Service",our business mainly focus on the distribution of electronic components. Line cards we deal with include Microchip,ALPS,ROHM,Xilinx,Pulse,ON,Everlight and Freescale. Main products comprise IC,Modules,Potentiometer,IC Socket,Relay,Connector.Our parts cover such applications as commercial,industrial, and automotives areas.

We are looking forward to setting up business relationship with you and hope to provide you with the best service and solution. Let us make a better world for our industry!



Contact us

Tel: +86-755-8981 8866 Fax: +86-755-8427 6832

Email & Skype: info@chipsmall.com Web: www.chipsmall.com

Address: A1208, Overseas Decoration Building, #122 Zhenhua RD., Futian, Shenzhen, China



P/N	CONTACT AREA PLATING	PACKAGE METHOD	REMARK
67490-1220	GOLD FLASH	WITHOUT MYLAR	PURE TIN
67490-1221	0.76 MICRONS GOLD PLATED	TRAY PACKAGE	
67490-1225	0.38 MICRONS GOLD PLATED	PK-67490-001	
67490-1230	GOLD FLASH	WITH MYLAR, TAPE REEL	
67490-1235	0.38 MICRONS GOLD PLATED	PK-67490-000	
67490-1240	GOLD FLASH	WITH MYLAR, TUBE PACKAGE	
67490-1245	0.38 MICRONS GOLD PLATED	PK-67490-002	

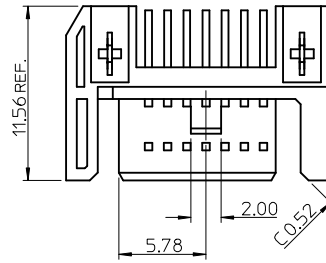

NOTES:

- MATERIAL:
HOUSING: HIGH TEMPERATURE THERMAL PLASTIC
GLASS FILLED, UL94V-0, COLOR: BLACK
TERMINAL/FORKLOCK: COPPER ALLOY
MYLAR: ADHENSIVE MYLAR 4.5MM X 15.5MM
- TERMINAL PLATING:
CONTACT AREA: GOLD PLATED
SOLDERING TAIL: 1.27 MICRONS MINIMUM TIN PLATED
UNDER PLATE: NICKEL 1.27 MICRONS MINIMUM NICKEL PLATED
- FORKLOCK PLATING:
1.27 MICRONS MINIMUM TIN PLATED OVERALL 1.27 MICRONS MINIMUM NICKEL UNDER-PLATED
- PACKAGING SPECIFICATION REFER TO TABLE
- PRODUCT SPECIFICATION REFER TO PS-67490-001
- MATING PART: 67538, 67489

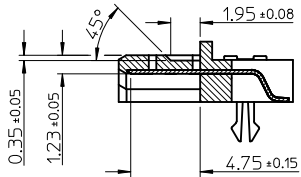

SECTION B-B
SCALE 3:1

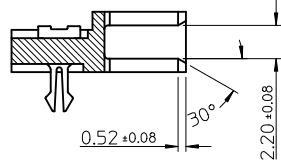

SECTION A-A
SCALE 3:1

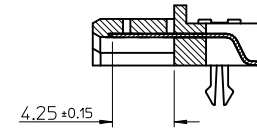
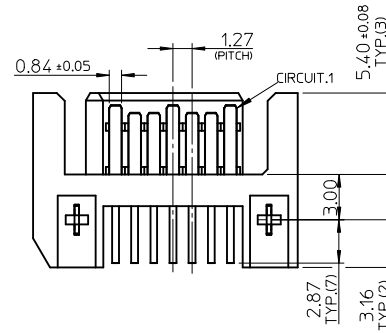
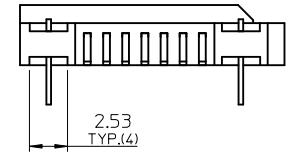
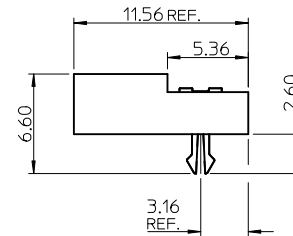
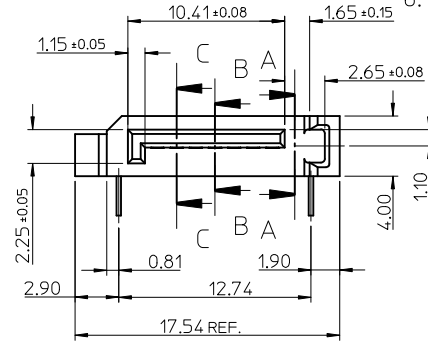

SECTION C-C
SCALE 3:1

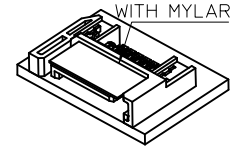

WITH MYLAR

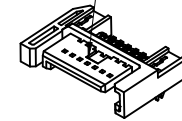

WITHOUT MYLAR

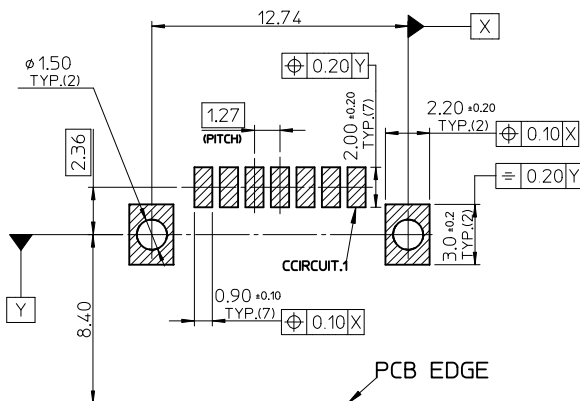

RECOMMEND P.C.B. LAYOUT (t=1.6)

REV	DESCRIPTION
1	REMOVE PART NUMBER
2	EC NO: SH2012-0062
3	DRWN:XQZHANG 2012/01/18
4	CHKD:XQZHANG 2012/01/30
5	APPR:AYIN 2012/02/02

QUALITY SYMBOLS	DESCRIPTION
$\nabla = 0$	
$\nabla = 0$	
$\nabla = 0$	

GENERAL TOLERANCES (UNLESS SPECIFIED)	
mm	INCH
4 PLACES ± ---	± ---
3 PLACES ± ---	± ---
2 PLACES ± 0.15	± ---
1 PLACE ± 0.25	± ---
ANGULAR ± 3°	

DIMENSION STYLE	
MM ONLY	
DRAWN BY	DATE
RICHARD	'01/08/08
CHECKED BY	DATE
VINCENT	'01/08/08
APPROVED BY	DATE
ERICK	'01/08/08

SCALE	DESIGN UNITS	THIRD ANGLE PROJECTION
4:1	METRIC	
TITLE		
SATA SYSTEM PLUG R/A STANDARD TYPE		
MATERIAL NO. SEE TABLE		
DOCUMENT NO. SD-67490-002		
SHEET NO. 1 OF 1		