



Chipsmall Limited consists of a professional team with an average of over 10 year of expertise in the distribution of electronic components. Based in Hongkong, we have already established firm and mutual-benefit business relationships with customers from,Europe,America and south Asia,supplying obsolete and hard-to-find components to meet their specific needs.

With the principle of “Quality Parts,Customers Priority,Honest Operation,and Considerate Service”,our business mainly focus on the distribution of electronic components. Line cards we deal with include Microchip,ALPS,ROHM,Xilinx,Pulse,ON,Everlight and Freescale. Main products comprise IC,Modules,Potentiometer,IC Socket,Relay,Connector.Our parts cover such applications as commercial,industrial, and automotives areas.

We are looking forward to setting up business relationship with you and hope to provide you with the best service and solution. Let us make a better world for our industry!



Contact us

Tel: +86-755-8981 8866 Fax: +86-755-8427 6832

Email & Skype: info@chipsmall.com Web: www.chipsmall.com

Address: A1208, Overseas Decoration Building, #122 Zhenhua RD., Futian, Shenzhen, China



7 6 5 4 3 2 1

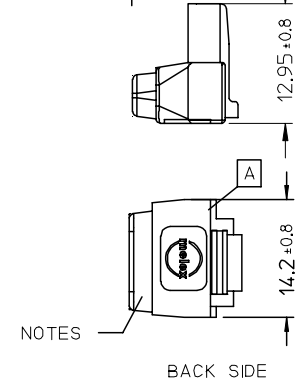
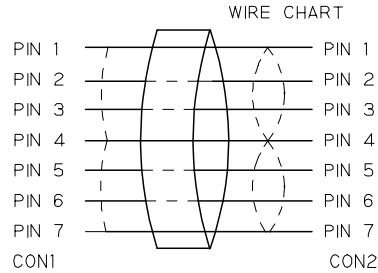
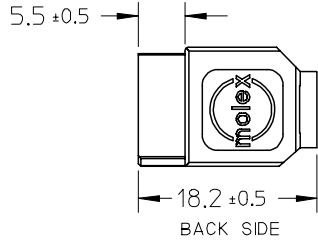
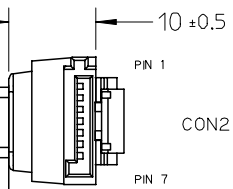
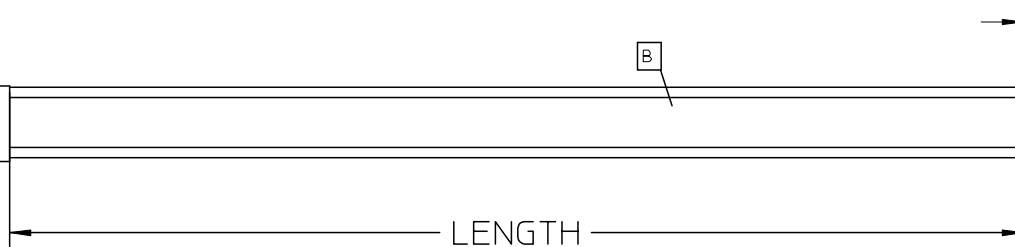
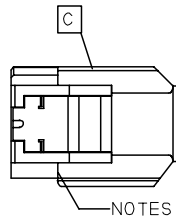
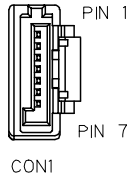

NOTE:
 PHYSICAL
 1. OUTER MOLD WITH BLACK PVC RESIN 887800042.
 INNER MOLD WITH PE RESIN 887800008.
 ELECTRICAL PERFORMANCE:
 2. DIELECTRONIC STRENGTH:500V DC/0.01S.
 3. INSULATION RESISTANCE:100M OHMS MIN.
 4. CONDUCTIVE RESISTOR: 2 OHMS MAX.

MOLEX P/N	LENGTH (mm)	LENGTH (inch)	DESCRIPTION
68561-0017	1000+/-20	40.0+/-0.8	S-ATA LATCHING STRAIGHT TO R/A CABLE. RED
68561-0016	500+/-10	20.0+/-0.4	S-ATA LATCHING STRAIGHT TO R/A CABLE. RED

ITEM	DESCRIPTION	QTY.
C	S-ATA STRAIGHT CONN. 674899002	1
B	2PX26AWG S-ATA CABLE RED 887808052	1
A	S-ATA R/A CONN. 674890002	1

ENTER DESCRIPTION EC NO: DG2005-0125 DRWN: JLIU13 CHKD: TEDDY APPR: TKAN	2005/04/04 2005/04/04 2005/04/04	DESCRIPTION REV	QUALITY SYMBOLS	GENERAL TOLERANCES (UNLESS SPECIFIED)	DIMENSION STYLE	SCALE	DESIGN UNITS	THIRD ANGLE PROJECTION
			▼=0 □=0	mm INCH	MM ONLY	---	METRIC	
			4 PLACES ± --- ± --- 3 PLACES ± --- ± --- 2 PLACES ± --- ± --- 1 PLACE ± --- ± ---	DRAWN BY: JLIU13 DATE: 2005/04/04 CHECKED BY: TEDDY DATE: 2005/04/04 APPROVED BY: BORON DATE: 2005/04/04	TITLE			
			ANGULAR ± ---° DRAFT WHERE APPLICABLE MUST REMAIN WITHIN DIMENSIONS	MATERIAL NO. 685610017 DOCUMENT NO. SD-68561-0017 SHEET NO. 1 OF 1	S-ATA STRAIGHT LATCHING TO R/A LATCHING SIGNAL CBL RED,0.5M,1.0M MOLEX INCORPORATED			

THIS DRAWING CONTAINS INFORMATION THAT IS PROPRIETARY TO MOLEX INCORPORATED AND SHOULD NOT BE USED WITHOUT WRITTEN PERMISSION

6 5 4 3 2 1

7 6 5 4 3 2 1

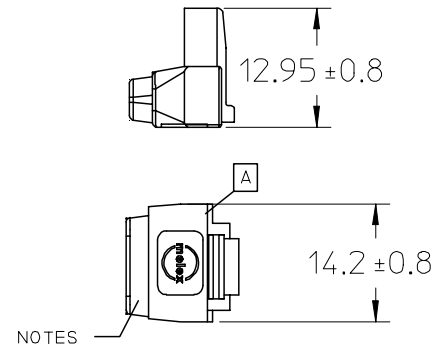
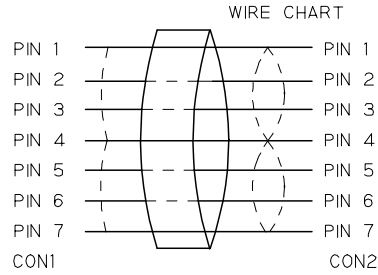
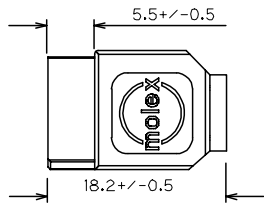
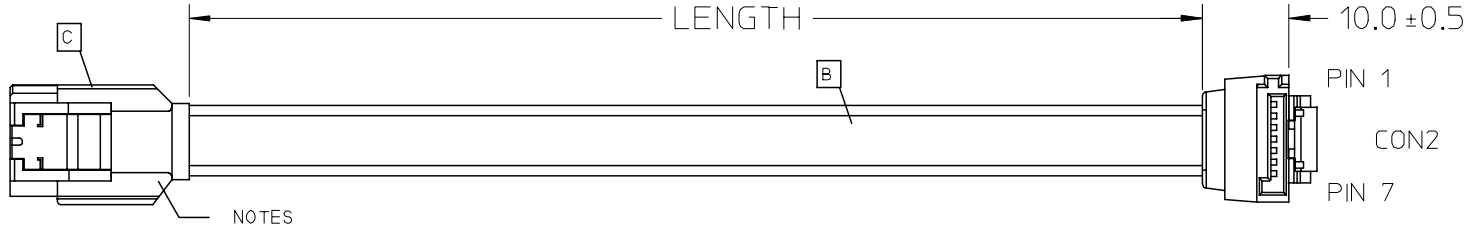
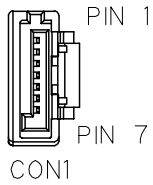

NOTE:
PHYSICAL

1. OUTER MOLD WITH BLACK PVC RESIN 887800042

ELECTRICAL PERFORMANCE:
2. DIELECTRONIC STRENGTH:500V DC
3. INSULATION RESISTANCE:100M OHMS
4. CONDUCTIVE RESISTOR: 2 OHMS

MOLEX P/N	LENGTH (mm)	LENGTH (inch)	DESCRIPTION
68561-0017	1000+/-20	40.0+/-0.8	S-ATA LATCHING STRAIGHT TO R/A CABLE. RED
68561-0016	500+/-10	20.0+/-0.4	S-ATA LATCHING STRAIGHT TO R/A CABLE. RED

ITEM	DESCRIPTION	L	QTY.
C	S-ATA STRAIGHT CONN. 674899002		1
B	2PX26AWG S-ATA CABLE RED 887808052	N/A	1
A	S-ATA R/A CONN. 674890002		1

ENTER DESCRIPTION EC NO: DG2005-0009 DRWN: GXYANG CHKD: APPR: BOCHEN	2004/08/11 2004/08/18 2004/08/18	DESCRIPTION REV	QUALITY SYMBOLS ▽=0 ◻=0	GENERAL TOLERANCES (UNLESS SPECIFIED)		DIMENSION STYLE MM ONLY		SCALE ---	DESIGN UNITS METRIC	THIRD ANGLE PROJECTION
						DRAWN BY GX YANG	DATE 04/08/10	TITLE S-ATA STRAIGHT LATCHING TO R/A LATCHING SIGNAL CBL RED,0.5M,1.0M		
						CHECKED BY TEDDY	DATE 04/08/10			
						APPROVED BY BORON	DATE 04/08/10	MOLEX INCORPORATED		
DRAFT WHERE APPLICABLE MUST REMAIN WITHIN DIMENSIONS		MATERIAL NO. 685610016/7	DOCUMENT NO. SD-68561-002	SHEET NO. 1 OF 1						

6 5 4 3 2 1