



Chipsmall Limited consists of a professional team with an average of over 10 year of expertise in the distribution of electronic components. Based in Hongkong, we have already established firm and mutual-benefit business relationships with customers from,Europe,America and south Asia,supplying obsolete and hard-to-find components to meet their specific needs.

With the principle of “Quality Parts,Customers Priority,Honest Operation,and Considerate Service”,our business mainly focus on the distribution of electronic components. Line cards we deal with include Microchip,ALPS,ROHM,Xilinx,Pulse,ON,Everlight and Freescale. Main products comprise IC,Modules,Potentiometer,IC Socket,Relay,Connector.Our parts cover such applications as commercial,industrial, and automotives areas.

We are looking forward to setting up business relationship with you and hope to provide you with the best service and solution. Let us make a better world for our industry!



Contact us

Tel: +86-755-8981 8866 Fax: +86-755-8427 6832

Email & Skype: info@chipsmall.com Web: www.chipsmall.com

Address: A1208, Overseas Decoration Building, #122 Zhenhua RD., Futian, Shenzhen, China



CKT	OPTION E W/O LATCHES EDP. NO.	DIM "A"	DIM "B"
2	70107-5002	7.11	2.54 +/-0.08
3	70107-5003	9.65	5.08 +/-0.08
4	70107-5004	12.19	7.62 +/-0.10
5	70107-5005	14.73	10.16 +/-0.10
6	70107-5006	17.27	12.70 +/-0.10
7	70107-5007	19.81	15.24 +/-0.10
8	70107-5008	22.35	17.78 +/-0.10

NOTES:

1. MATERIAL: GLASS FILLED POLYESTER, UL 94V-0, COLOR: BLACK.
2. HOUSING TO BE USED WITH TERMINAL PART NUMBER 70021-****, AND TERMINAL POSITION ASSURANCE 73838.
3. SEE TABLE FOR CIRCUIT SIZES.
4. TO BE USED WITH 70400 SERIES CONNECTORS (STYLE "G").
5. PACKAGE PER PK-70107-100.

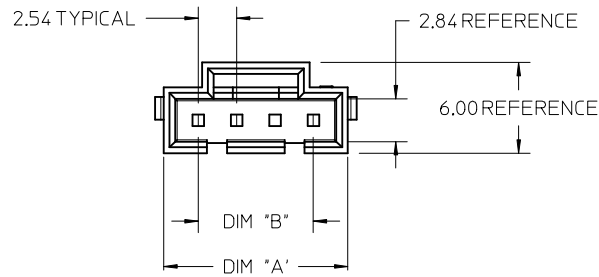

2 CIRCUIT

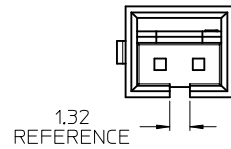

3 CIRCUIT

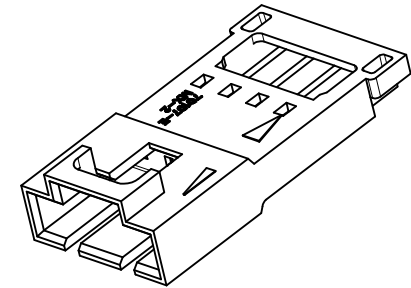
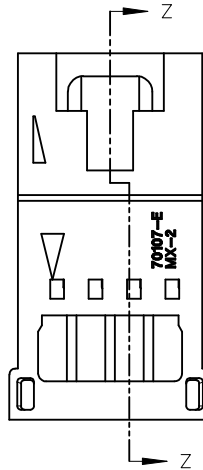
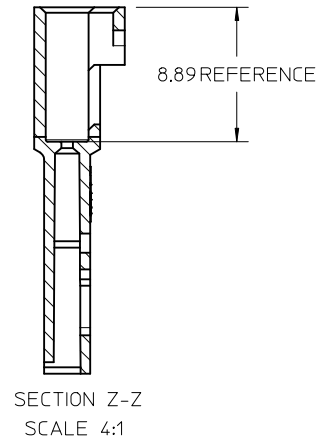
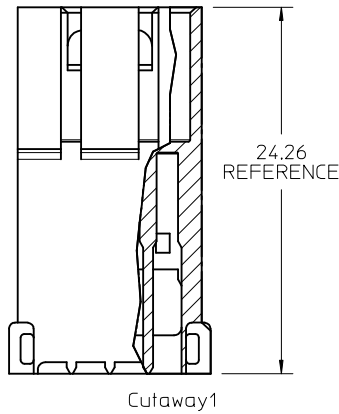
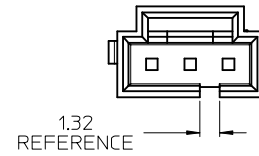

CHANGE P/N'S IN TABLE EC NO: UCP2015-0241 DRAWN: RWHIPPLE 2014/07/21 CHKD: MPOFF 2014/07/21 APPR: SMILLER 2014/08/04	QUALITY SYMBOLS 	GENERAL TOLERANCES (UNLESS SPECIFIED)		DIMENSION STYLE	SCALE	DESIGN UNITS	THIRD ANGLE PROJECTION		
				MM ONLY	10:1	METRIC			
				DRAWN BY DATE		TITLE			
				CHECKED BY DATE		HOUSING, CONNECTOR (2.54)/100 GRID VERSION E W/O LATCHES			
REV B	DESCRIPTION	ANGULAR ±1/2°		MATERIAL NO.	DOCUMENT NO.	SHEET NO.			
		DRAFT WHERE APPLICABLE MUST REMAIN WITHIN DIMENSIONS		SEE TABLE	SD-70107-500	1 OF 1			
				THIS DRAWING CONTAINS INFORMATION THAT IS PROPRIETARY TO MOLEX INCORPORATED AND SHOULD NOT BE USED WITHOUT WRITTEN PERMISSION					