



Chipsmall Limited consists of a professional team with an average of over 10 year of expertise in the distribution of electronic components. Based in Hongkong, we have already established firm and mutual-benefit business relationships with customers from,Europe,America and south Asia,supplying obsolete and hard-to-find components to meet their specific needs.

With the principle of “Quality Parts,Customers Priority,Honest Operation,and Considerate Service”,our business mainly focus on the distribution of electronic components. Line cards we deal with include Microchip,ALPS,ROHM,Xilinx,Pulse,ON,Everlight and Freescale. Main products comprise IC,Modules,Potentiometer,IC Socket,Relay,Connector.Our parts cover such applications as commercial,industrial, and automotives areas.

We are looking forward to setting up business relationship with you and hope to provide you with the best service and solution. Let us make a better world for our industry!



Contact us

Tel: +86-755-8981 8866 Fax: +86-755-8427 6832

Email & Skype: info@chipsmall.com Web: www.chipsmall.com

Address: A1208, Overseas Decoration Building, #122 Zhenhua RD., Futian, Shenzhen, China



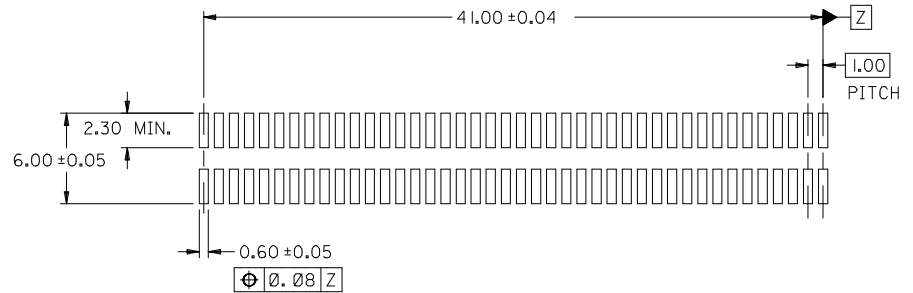
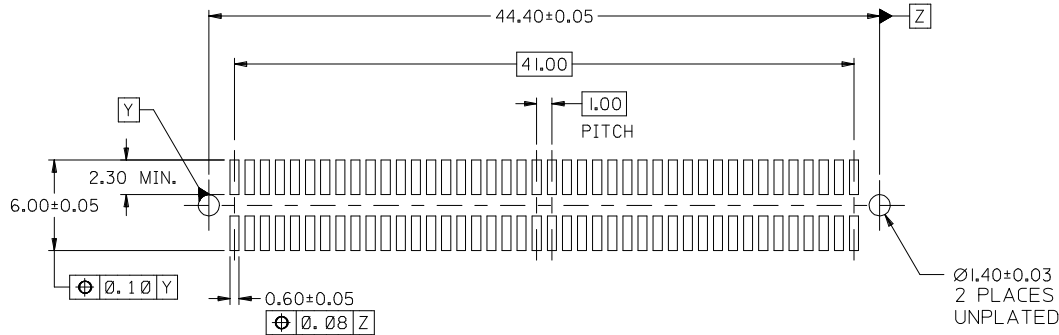
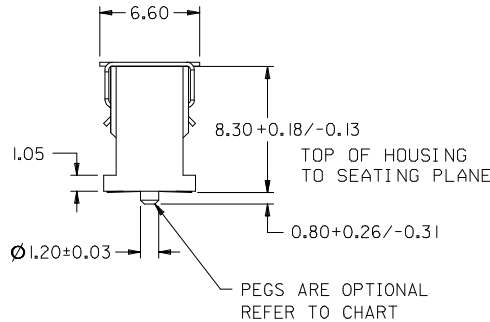
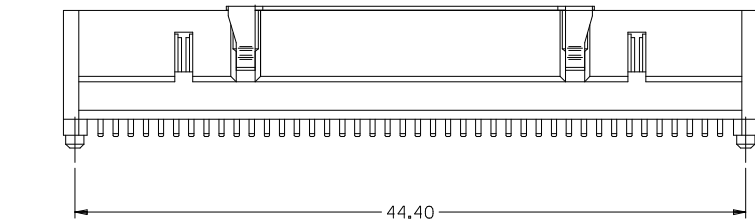
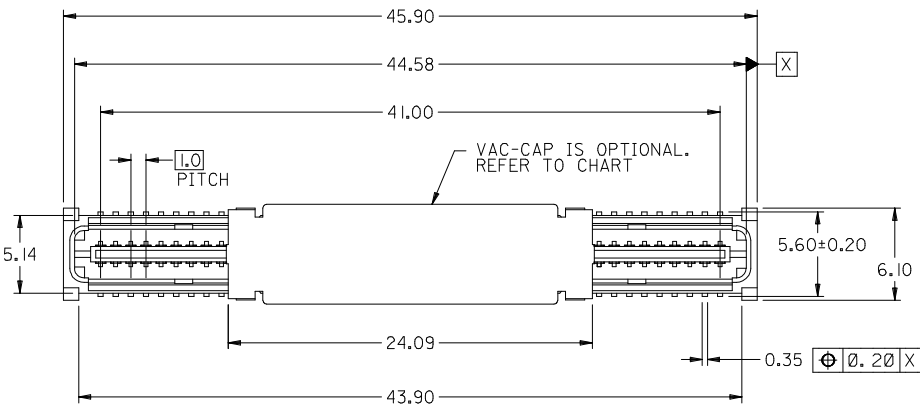

RECOMMENDED PCB LAYOUT

RECOMMENDED PCB THICKNESS: 1.0±0.1mm MIN.

**RECOMMENDED PCB LAYOUT
(WITHOUT PEGS)**

RECOMMENDED PCB THICKNESS: 1.0±0.1mm MIN.

71741-0004	YES	YES	PK-70873-063	TAPE & REEL	0.76 GOLD
71741-0003	NO	YES	PK-70873-063	TAPE & REEL	0.76 GOLD
71741-0002	YES	YES	PK-70873-063	TAPE & REEL	0.25 GOLD
71741-0001	YES	NO	PK-70873-0607	TUBE	0.25 GOLD
ITEM NUMBER	PEGS	PICK & PLACE CAP	PACKAGING SPEC. NUMBER	PACKAGING TYPE	TERMINAL PLATING

PLATING

0.76 GOLD - 0.76 MICROMETERS MINIMUM GOLD PLATING IN CONTACT AREA, 1.90 MICROMETERS MINIMUM TIN PLATING IN TERMINAL AREA, OVER NICKEL PLATING OVERALL

0.25 GOLD - 0.25 MICROMETERS MINIMUM GOLD PLATING IN CONTACT AREA, 1.00 MICROMETERS MINIMUM TIN PLATING IN TERMINAL AREA, OVER NICKEL PLATING OVERALL

NOTES:

- HOUSING MATERIAL: G.F. THERMOPLASTIC; UL RATING: 94V-0; COLOR: WHITE
TERMINAL MATERIAL: PHOSPHOR BRONZE
VACUUM CAP MATERIAL: STAINLESS STEEL
- COPLANARITY OF SMT TAILS: 0.10 MAX.
- PACKAGING SPECIFICATIONS: REFER TO CHART
- DIMENSIONS ARE IN MILLIMETERS.
- THIS PART, WHEN MATED WITH MOLEX U.S. PART NO. 71742-0*** OR MOLEX JAPAN PART NO. 52841-0848, CONFORMS TO MOLEX PRODUCT SPECIFICATION PS-71741-9999.

ADD 12 MM STACK EC NO: UCP2009-2408 IDRW:BBARKER 2009/04/20 CHKD:DMORGAN 2009/04/20 APPR:SMILLER 2009/04/21	QUALITY SYMBOLS	GENERAL TOLERANCES (UNLESS SPECIFIED)	DIMENSION STYLE	SCALE	DESIGN UNITS	THIRD ANGLE PROJECTION	
	$\nabla=0$ $\nabla=0$	mm INCH	MM ONLY	METRIC			
		4 PLACES ± --- ± --- 3 PLACES ± --- ± --- 2 PLACES ± 0.18 ± --- 1 PLACE ± 0.33 ± --- ANGULAR ± 1/2°	DRAWN BY DATE REED 96/07/15 CHECKED BY DATE REED 96/07/15 APPROVED BY DATE BIXLER 96/07/15	TITLE			
		DRAFT WHERE APPLICABLE MUST REMAIN WITHIN DIMENSIONS	SEE TABLE	SALES ASSEMBLY, 1 MM 84 CKT, BTB PLUG 4.30 MM STACK HEIGHT MOLEX INCORPORATED	DOCUMENT NO. SDA-71741-0***	SHEET NO. 1 OF 2	

THIS DRAWING CONTAINS INFORMATION THAT IS PROPRIETARY TO MOLEX INCORPORATED AND SHOULD NOT BE USED WITHOUT WRITTEN PERMISSION

RECOMMENDED PLUG/RECEPTACLE COMBINATION FOR
MATED STACK HEIGHT PER EIA STANDARD 700 AAAB

MATED STACK HEIGHT	RECEPTACLE HEIGHT	RECEPTACLE SERIES NO.	PLUG HEIGHT	PLUG SERIES NO.
10.00/.394	5.30/.209	71742-0***	4.30/.169	71741-0***
12.00/.472	7.30/.287	71742-2***		
15.00/.591	10.30/.406	71742-3***		

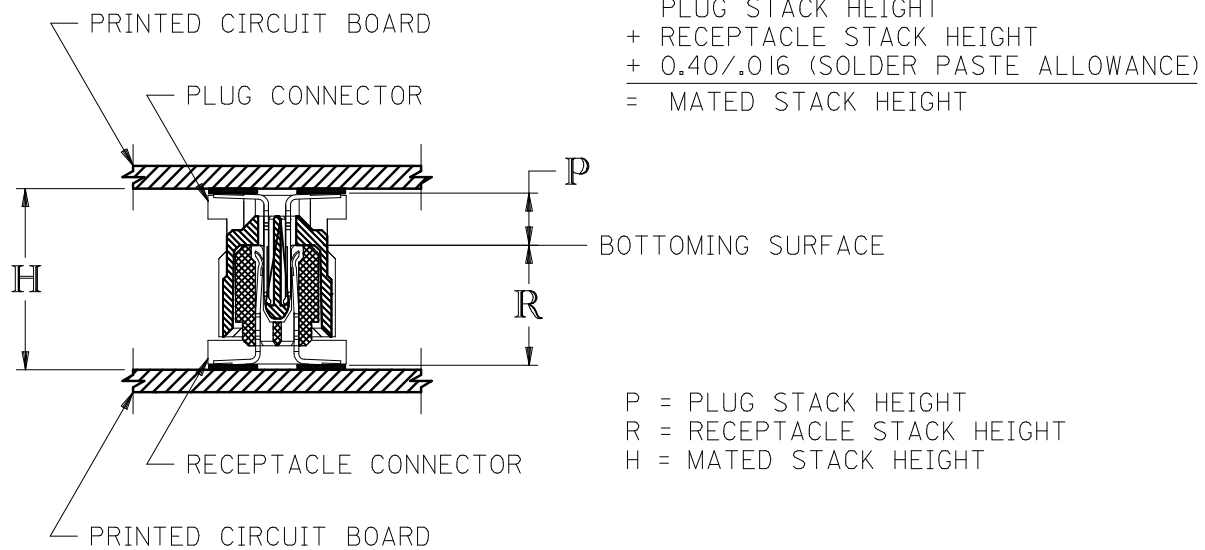

SEE SHEET 1 EC NO: UCP2009-2408 2009/04/20 DRWN:BBARKER 2009/04/20 CHKD:DMORGAN 2009/04/20 APPR:SMILLER 2009/04/21	QUALITY SYMBOLS	GENERAL TOLERANCES (UNLESS SPECIFIED)	DIMENSION STYLE	SCALE	DESIGN UNITS	THIRD ANGLE PROJECTION
	$\nabla=0$ $\nabla=0$	mm INCH	MM ONLY	1:1	METRIC	
		4 PLACES ± --- ± ---	DRAWN BY DATE	TITLE		
		3 PLACES ± --- ± ---	CHECKED BY DATE	SALES ASSEMBLY, 1 MM 84 CKT, BTB PLUG 4.30 MM STACK HEIGHT		
	2 PLACES ± 0.18 ± ---	REED DATE	MOLEX INCORPORATED			
	1 PLACE ± 0.33 ± ---	APPROVED BY DATE	SDA-71741-0***			
	ANGULAR ± 1/2°	BIXLER 96/07/15	SHEET NO. 2 OF 2			
	DRAFT WHERE APPLICABLE MUST REMAIN WITHIN DIMENSIONS	MATERIAL NO.	DOCUMENT NO.			
		SEE TABLE	THIS DRAWING CONTAINS INFORMATION THAT IS PROPRIETARY TO MOLEX INCORPORATED AND SHOULD NOT BE USED WITHOUT WRITTEN PERMISSION			

RECOMMENDED PLUG/RECEPTACLE COMBINATION FOR
MATED STACK HEIGHT PER EIA STANDARD 700 AAAB

MATED STACK HEIGHT	RECEPTACLE HEIGHT	RECEPTACLE SERIES NO.	PLUG HEIGHT	PLUG SERIES NO.
10.00/.394	5.30/.209	71742-0***	4.30/.169	71741-0***
15.00/.591	10.30/.406	71742-3***	4.30/.169	71741-0***

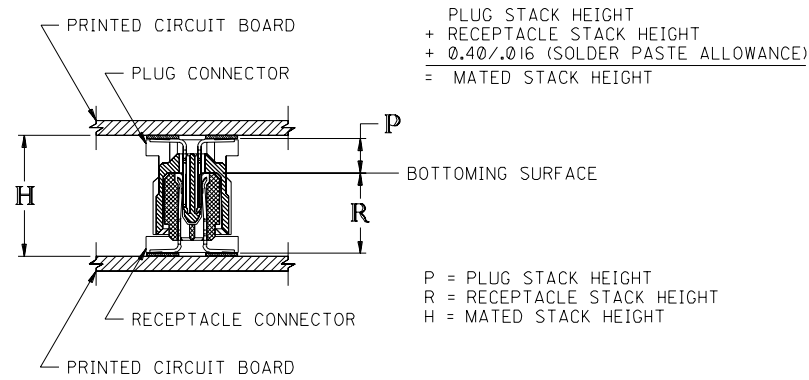

METRIC

REVISE ONLY ON CAD SYSTEM

UNLESS OTHERWISE SPECIFIED
TOLERANCES ANGULAR ± 1/2°

	INCH	METRIC
3 PLACE	± ----	----
2 PLACE	± ----	± ----
1 PLACE	----	± ----

DRAFT WHERE APPLICABLE MUST
REMAIN WITHIN DIMENSIONS

TITLE SALES ASSY, 1.0mm 84 CKT. BOARD-TO-BOARD PLUG 4.30/.169 STACK HEIGHT		SHEET NO. 2	DATE 98/12/28
MOLEX INCORPORATED L15LEJLL 60532 U.S.A.		PART NO. SEE SHT 1	DRWG. NO. SDA-71741-0***
FILE NAME S717410 DGN	THIS DRAWING CONTAINS INFORMATION THAT IS PROPRIETARY TO MOLEX INC. AND SHOULD NOT BE USED WITHOUT WRITTEN PERMISSION		DIV. CPP

DRWG. BY KAS	CHK'D. BY KAS
APP'D. BY DJB	SCALE NONE

LTR.	REVISIONS	LTR.	REVISIONS
------	-----------	------	-----------