



Chipsmall Limited consists of a professional team with an average of over 10 year of expertise in the distribution of electronic components. Based in Hongkong, we have already established firm and mutual-benefit business relationships with customers from,Europe,America and south Asia,supplying obsolete and hard-to-find components to meet their specific needs.

With the principle of “Quality Parts,Customers Priority,Honest Operation,and Considerate Service”,our business mainly focus on the distribution of electronic components. Line cards we deal with include Microchip,ALPS,ROHM,Xilinx,Pulse,ON,Everlight and Freescale. Main products comprise IC,Modules,Potentiometer,IC Socket,Relay,Connector.Our parts cover such applications as commercial,industrial, and automotives areas.

We are looking forward to setting up business relationship with you and hope to provide you with the best service and solution. Let us make a better world for our industry!



## Contact us

Tel: +86-755-8981 8866 Fax: +86-755-8427 6832

Email & Skype: info@chipsmall.com Web: www.chipsmall.com

Address: A1208, Overseas Decoration Building, #122 Zhenhua RD., Futian, Shenzhen, China



MATERIALS AND FINISHES :

BODY, COUPLING NUT, CRIMP TUBE BRASS  
PLATED NICKEL

CONTACT BERYLLIUM COPPER  
PLATED GOLD (SEE TABLE)

CABLE CONTACT BRASS  
PLATED GOLD

INSULATOR TEFLON

SHRINK TUBE ATUM OR EQUIVALENT

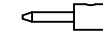
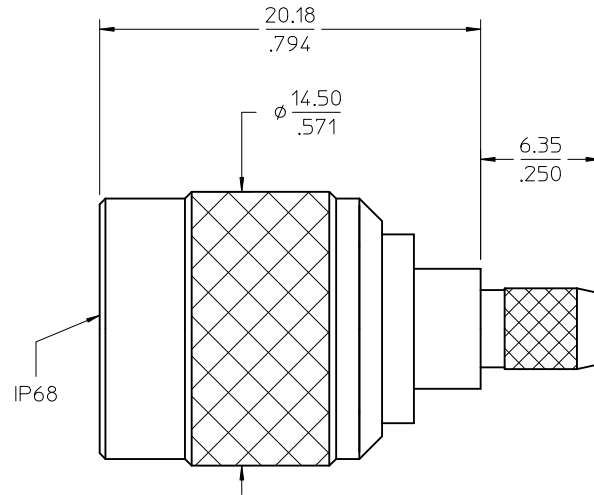
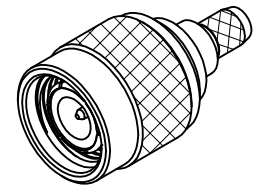

CONTACT

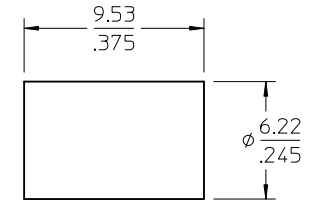

CRIMP TUBE

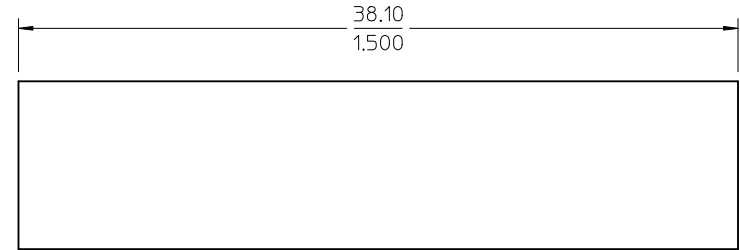

SHRINK TUBE

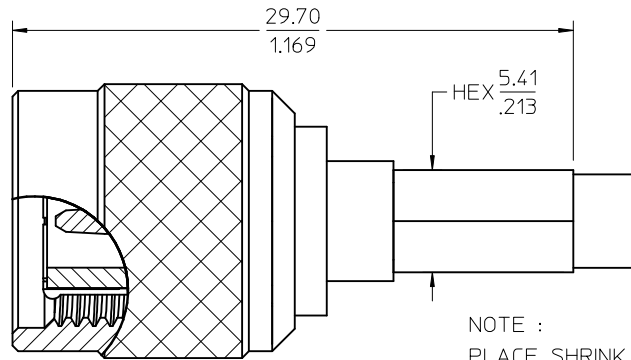

NOTE :  
PLACE SHRINK TUBE  
ONTO CABLE PRIOR  
TO INSERTION IN BODY

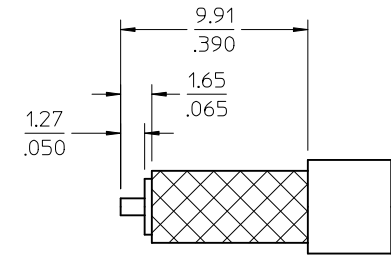
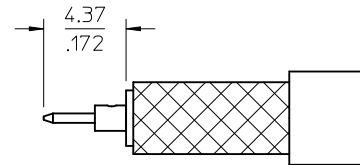

RECOMMENDED CABLE STRIP  
DIMENSIONS

MIL-STD-348A, FIG. 313.1	INTERFACE
SPECIFICATION	DESCRIPTION

73216-1982	10u"	ONE PER BAG
73216-1981	10u"	BULK
73216-1980	30u"	BULK
PART NO.	CONTACT PLTG	PACKAGING

CHG: ADD 73216-1982

EC NO: 2012/01/30  
DRWN:JIENER 2012/01/30  
CHKD:SSS 2012/01/30  
APPR:JIENER 2012/01/31

DESCRIPTION  
REV: A2

QUALITY SYMBOLS  
▽=0  
▽=0

GENERAL TOLERANCES (UNLESS SPECIFIED)  
4 PLACES ± .005 ± .005  
3 PLACES ± .005 ± .005  
2 PLACES ± .005 ± .005  
1 PLACE ± .005 ± .005  
ANGULAR ± 2°  
DRAFT WHERE APPLICABLE  
MUST REMAIN  
WITHIN DIMENSIONS

DIMENSION STYLE  
MM/IN  
DRAWN BY DATE  
AZR 2008/12/01  
CHECKED BY DATE  
SSS 2008/12/01  
APPROVED BY DATE  
JDW 2008/12/01  
MATERIAL NO.  
SEE NOTE  
SIZE C

SCALE  
DESIGN UNITS  
METRIC  
THIRD ANGLE PROJECTION  
TITLE  
TNC PLUG STRAIGHT IP68  
FOR RG58 50 OHMS  
TNC-PC, EWR-3829  
DOCUMENT NO.  
SD-73216-198  
SHEET NO.  
1 OF 1  
THIS DRAWING CONTAINS INFORMATION THAT IS PROPRIETARY TO MOLEX INCORPORATED AND SHOULD NOT BE USED WITHOUT WRITTEN PERMISSION