



Chipsmall Limited consists of a professional team with an average of over 10 year of expertise in the distribution of electronic components. Based in Hongkong, we have already established firm and mutual-benefit business relationships with customers from,Europe,America and south Asia,supplying obsolete and hard-to-find components to meet their specific needs.

With the principle of "Quality Parts,Customers Priority,Honest Operation,and Considerate Service",our business mainly focus on the distribution of electronic components. Line cards we deal with include Microchip,ALPS,ROHM,Xilinx,Pulse,ON,Everlight and Freescale. Main products comprise IC,Modules,Potentiometer,IC Socket,Relay,Connector.Our parts cover such applications as commercial,industrial, and automotives areas.

We are looking forward to setting up business relationship with you and hope to provide you with the best service and solution. Let us make a better world for our industry!



## Contact us

Tel: +86-755-8981 8866 Fax: +86-755-8427 6832

Email & Skype: info@chipsmall.com Web: www.chipsmall.com

Address: A1208, Overseas Decoration Building, #122 Zhenhua RD., Futian, Shenzhen, China





MATERIALS AND FINISHES

SEE SD-73412-050

P/N: 73118-0250: THIS IS P/N: 73412-0502 PLACED IN A SINGLE BAG WITH LABEL

CHG: TITLE CHG TO  
MCRF25 FROM UJFL  
EC NO: URF2016-0030 2015/07/27  
DRWN: YCHENG  
CHKD:  
APPR: YCHENG 2015/07/28  
A1

QUALITY SYMBOLS  
 = 0  
 = 0  
 DESCRIPTION  
 REV

GENERAL TOLERANCES (UNLESS SPECIFIED)

	mm	INCH
4 PLACES	± .---	± .---
3 PLACES	± .---	± .---
2 PLACES	± .---	± .---
1 PLACE	± .---	± .---
ANGULAR ± .---°		

DRAFT WHERE APPLICABLE  
MUST REMAIN  
WITHIN DIMENSIONS

DIMENSION STYLE  
MM/IN

DRAWN BY	DATE
AROBERTSON	2011/05/04
CHECKED BY	DATE
SSS	2011/05/04
APPROVED BY	DATE
JWIENER	2011/05/05

MATERIAL NO. SEE TABLE

SCALE DESIGN UNITS METRIC

THIRD ANGLE PROJECTION

TITLE  
CA MCRF25 TO MCRF25 WITH  
50 OHM ON 1.32 CABLE  
CA-MCRF25/MCRF25

 MOLEX INCORPORATED

DOCUMENT NO. SD-73118-025

SHEET NO. 1 OF 1

THIS DRAWING CONTAINS INFORMATION THAT IS PROPRIETARY TO MOLEX INCORPORATED AND SHOULD NOT BE USED WITHOUT WRITTEN PERMISSION

MATERIALS AND FINISHES

MATED HEIGHT : 2.5MM (.098)

BODY: PHOSPHOR BRONZE  
PLATED GOLD

CENTER CONTACT: PHOSPHOR BRONZE  
PLATED GOLD

HOUSING: PBT

CABLE: 1.32 CABLE

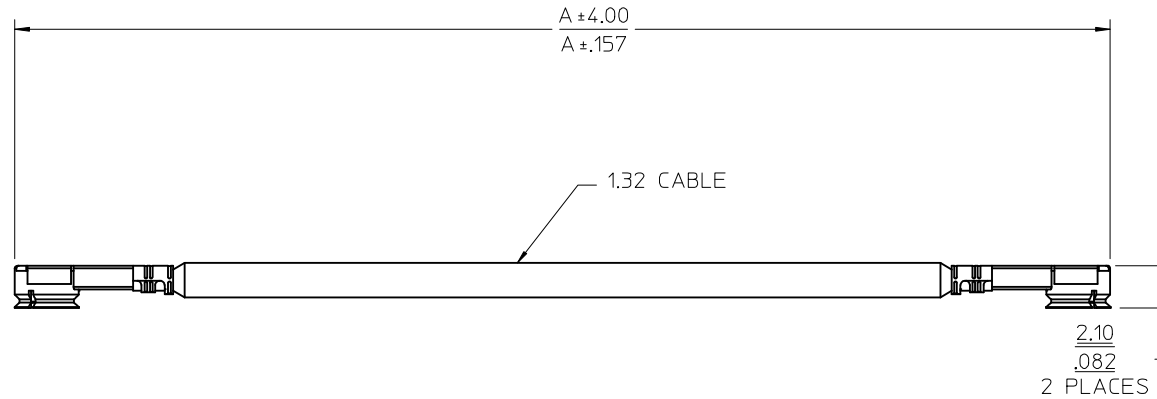
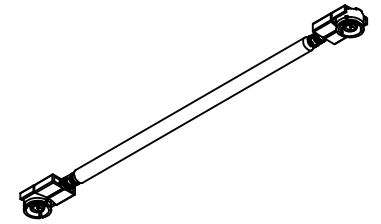

5	73412-0508	50.00	1.969
4	73412-0506	90.00	3.543
3	73412-0504	162.00	6.378
2	73412-0502	110.00	4.330
1	73412-0500	42.00	1.650
	PART NO.	DIMENSION A	

PART NO. 73118-0250 IS 73412-0502  
PACKAGED ONE PIECE PER BAG

CHG: 1) TITLE CHG TO MCRF25 2) DIM. UPDATE 2.10 WAS 2.00 3) REMOVE "U.F.L." EC NO: URF2016-0030 DRAWN: YCHENG 2015/07/16 CHKD: APPR: YCHENG 2015/07/28 C4	QUALITY SYMBOLS ▽=0 ▽=0	GENERAL TOLERANCES (UNLESS SPECIFIED) <table border="1"> <tr> <td></td> <td>mm</td> <td>INCH</td> </tr> <tr> <td>4 PLACES</td> <td>± .005</td> <td>± .0002</td> </tr> <tr> <td>3 PLACES</td> <td>± .005</td> <td>± .0002</td> </tr> <tr> <td>2 PLACES</td> <td>± .005</td> <td>± .0002</td> </tr> <tr> <td>1 PLACE</td> <td>± .005</td> <td>± .0002</td> </tr> </table> ANGULAR ± 2°		mm	INCH	4 PLACES	± .005	± .0002	3 PLACES	± .005	± .0002	2 PLACES	± .005	± .0002	1 PLACE	± .005	± .0002	DIMENSION STYLE MM/IN	SCALE DESIGN UNITS METRIC	THIRD ANGLE PROJECTION
		mm	INCH																	
	4 PLACES	± .005	± .0002																	
	3 PLACES	± .005	± .0002																	
2 PLACES	± .005	± .0002																		
1 PLACE	± .005	± .0002																		
DRAWN BY YCHENG	DATE 2010/04/30	TITLE CA MCRF25 TO MCRF25 WITH 1.32 CABLE CA-MCRF25/MCRF25																		
CHECKED BY KERRIE	DATE 2010/04/30																			
APPROVED BY MHUANG	DATE 2010/05/10	MOLEX INCORPORATED																		
MATERIAL NO. SEE TABLE		DOCUMENT NO. SD-73412-050		SHEET NO. 1 OF 2																
DRAFT WHERE APPLICABLE MUST REMAIN WITHIN DIMENSIONS THIS DRAWING CONTAINS INFORMATION THAT IS PROPRIETARY TO MOLEX INCORPORATED AND SHOULD NOT BE USED WITHOUT WRITTEN PERMISSION																				

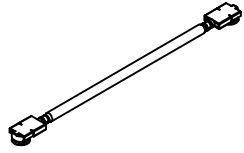

PART NO. 73412-050X

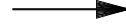

1000 PCS PER BAG  
BAG P/N: 89707-0176

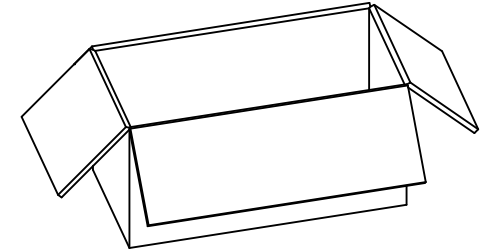

10000 PCS PER CARTON BOX  
CARTON BOX P/N: 96707-0002

SEE SHEET 1 EC NO: URF2016-0030 DRAWN: YCHENG 2015/07/16 CHKD: APPR: YCHENG 2015/07/28	DESCRIPTION REV	QUALITY SYMBOLS	GENERAL TOLERANCES (UNLESS SPECIFIED)		DIMENSION STYLE MM/IN		SCALE 1:5	DESIGN UNITS METRIC	THIRD ANGLE PROJECTION	
		▽=0	mm	INCH	DRAWN BY YCHENG	DATE 2010/04/30	TITLE CA MCRF25 TO MCRF25 WITH 1.32 CABLE CA-MCRF25/MCRF25 <b>molex</b>	DOCUMENT NO. SD-73412-050	SHEET NO. 2 OF 2	
		▽=0	4 PLACES ±	±	CHECKED BY KERRIE	DATE 2010/04/30				
		▽=0	3 PLACES ±	±	APPROVED BY MHUANG	DATE 2010/05/10				
	2 PLACES ±	±	MATERIAL NO.							
C4			ANGULAR ± 2 °		SEE SHEET 1					
			DRAFT WHERE APPLICABLE MUST REMAIN WITHIN DIMENSIONS		SIZE		THIS DRAWING CONTAINS INFORMATION THAT IS PROPRIETARY TO MOLEX INCORPORATED AND SHOULD NOT BE USED WITHOUT WRITTEN PERMISSION			