



Chipsmall Limited consists of a professional team with an average of over 10 year of expertise in the distribution of electronic components. Based in Hongkong, we have already established firm and mutual-benefit business relationships with customers from,Europe,America and south Asia,supplying obsolete and hard-to-find components to meet their specific needs.

With the principle of “Quality Parts,Customers Priority,Honest Operation,and Considerate Service”,our business mainly focus on the distribution of electronic components. Line cards we deal with include Microchip,ALPS,ROHM,Xilinx,Pulse,ON,Everlight and Freescale. Main products comprise IC,Modules,Potentiometer,IC Socket,Relay,Connector.Our parts cover such applications as commercial,industrial, and automotives areas.

We are looking forward to setting up business relationship with you and hope to provide you with the best service and solution. Let us make a better world for our industry!



## Contact us

Tel: +86-755-8981 8866 Fax: +86-755-8427 6832

Email & Skype: info@chipsmall.com Web: www.chipsmall.com

Address: A1208, Overseas Decoration Building, #122 Zhenhua RD., Futian, Shenzhen, China



# FUSEHOLDERS

## Accessories

### Accessories for fuseholders



Anti-rotation washer for fuseholders for round mounting holes

Order No.  
0696.0033 \*

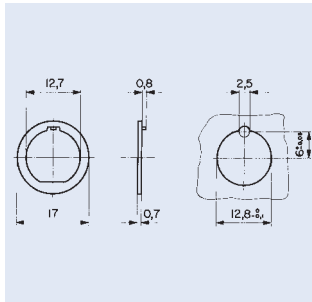

Transparent cover  
0853.0551



Reflow-Cover  
0853.0571

Order No.  
0853.0551 \* / 0853.0571 \*

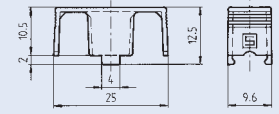

Reflow-Cover with clamp  
0853.0576

Order No.  
0853.0576 \*

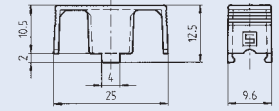

0583.0007

Metal nut

Order No.  
0098.0026 \*

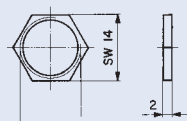

M 12,7 x 1,5  
double start thread



Marking plate self-adhesive

Order No.  
0880.0001 \*

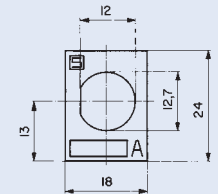

0583.0016

Plastic-nut (max. torque 1,2 Nm)

Order No.  
0098.0093 \*

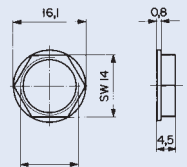

M 12,7 x 1,5  
double start thread



Marking plate self-adhesive

Order No.  
0880.0002 \*

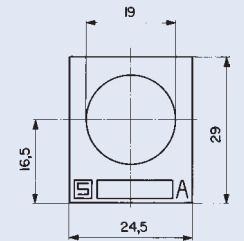

straight

Screw-adapter for quick connect-terminals 6,3 x 0,8 mm

Order No.  
0750.0141 \*

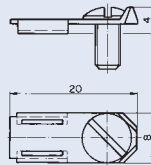

Insulating covers

a) to fuseholder types FIZ/FUL



b) to fuseholders with a socket diameter of 13 mm

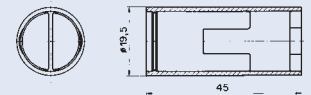

angled

Screw-adapter for quick connect-terminals 6,3 x 0,8 mm

Order No.  
0750.0142 \*

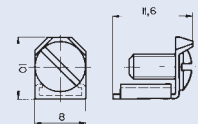

Order No.  
a) 0859.0046 \*  
b) 0859.0080 \*

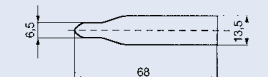

Cover for fuseholders  
OG 0751.0052/62,  
UHB 0031.5101, OG 0031.8001,  
UH 0031.5001, 0031.5010

Order No.  
0853.9561 \* 1,6 W  
0853.9562 \* 2,5 W

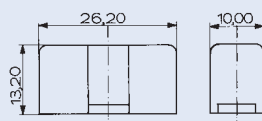

Insulating cover for fuseholders FEU

Order No.  
0859.0041 for FEU 0031.1653 \*  
0859.0042 for FEU 0031.1673 \*  
0031.1681 \*  
0859.0043 for FEU 0031.1694 \*

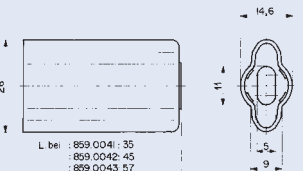

\* Packaging unit 100 pieces