



Chipsmall Limited consists of a professional team with an average of over 10 year of expertise in the distribution of electronic components. Based in Hongkong, we have already established firm and mutual-benefit business relationships with customers from,Europe,America and south Asia,supplying obsolete and hard-to-find components to meet their specific needs.

With the principle of "Quality Parts,Customers Priority,Honest Operation,and Considerate Service",our business mainly focus on the distribution of electronic components. Line cards we deal with include Microchip,ALPS,ROHM,Xilinx,Pulse,ON,Everlight and Freescale. Main products comprise IC,Modules,Potentiometer,IC Socket,Relay,Connector.Our parts cover such applications as commercial,industrial, and automotives areas.

We are looking forward to setting up business relationship with you and hope to provide you with the best service and solution. Let us make a better world for our industry!



Contact us

Tel: +86-755-8981 8866 Fax: +86-755-8427 6832

Email & Skype: info@chipsmall.com Web: www.chipsmall.com

Address: A1208, Overseas Decoration Building, #122 Zhenhua RD., Futian, Shenzhen, China



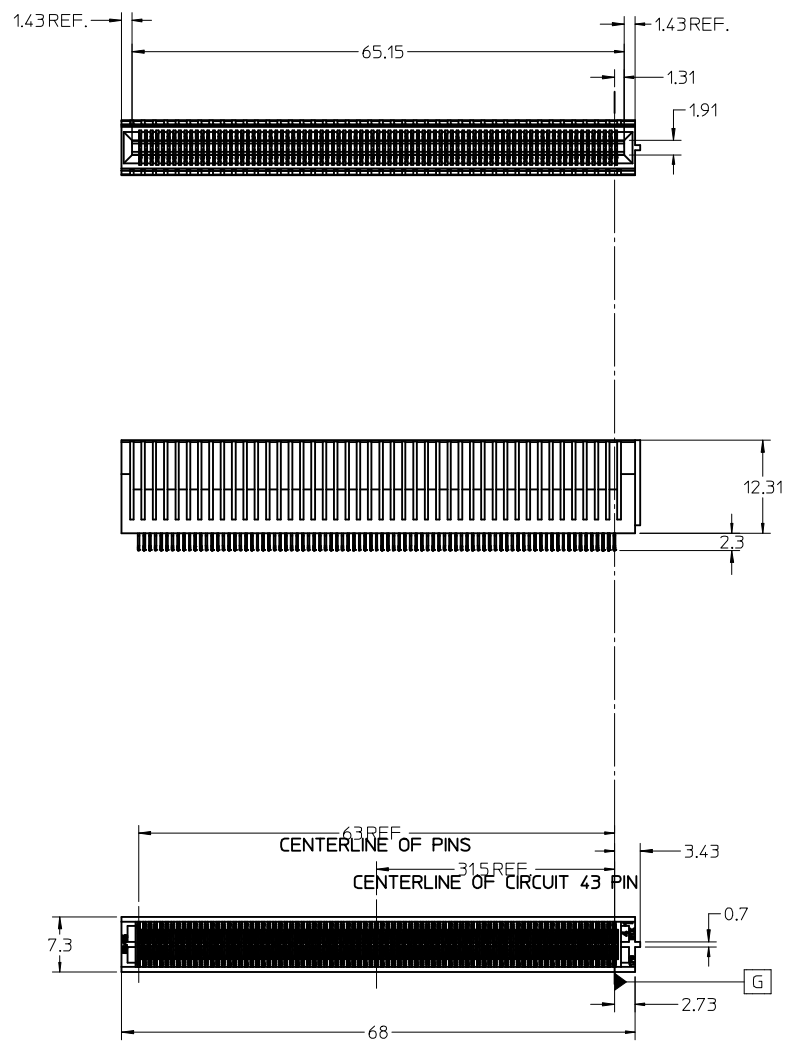

NOTES:

1. MATERIAL:
HOUSING - GLASS FILLED THERMOPLASTIC, 94-V0, BLACK
TERMINALS - BRASS
2. FINISH:
CONTACT AREA: HARD GOLD -0.76μm MIN OVER 3.80μ NICKEL
COMPLIANT AREA: TIN - 0.76/1.52μm OVERALL NICKEL
3. REFER TO PS-75594-999 PRODUCT SPECIFICATION FOR ALL ELECTRICAL, MECHANICAL AND ENVIROMENTAL SPECIFICATIONS.
4. REFER TO PK-75594-999 FOR ALL PACKAGING SPECIFICATIONS.
5. PROCESSING: PRESSFIT TO PC BOARD.
6. IN ORDER TO PROVIDE OPTIMAL ELECTRICAL PERFORMANCE, THE MATING BOARD MUST MEET REQUIREMENTS OF AMC.0 R2 SPECIFICATION.
7. MATING PC BOARD THICKNESS = 1.60±0.16MM OVER CONTACT PADS.

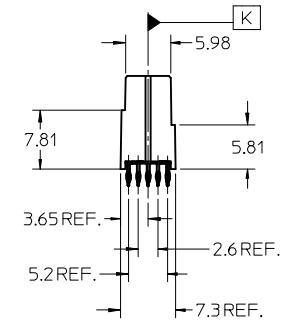

ADDED PAGE 3 EC NO: UCP2009-2429 DRWN: DROSCA 2009/05/18 CHKD: 2009/05/20 APPR: JCOMERC I 2009/05/20	QUALITY SYMBOLS ▽=0 ▽=0	GENERAL TOLERANCES (UNLESS SPECIFIED)		DIMENSION STYLE MM ONLY		SCALE 2:1	DESIGN UNITS METRIC	THIRD ANGLE PROJECTION		
			mm	INCH	DRAWN BY DROSCA	DATE 04/28/2008	SALES ASSEMBLY EDGE CARD, 75 MM PITCH 170 CIRCUIT			
		4 PLACES ± ---	± ---	± ---	CHECKED BY JCOMERC I	DATE 04/28/2008				
		3 PLACES ± ---	± ---	± ---	APPROVED BY JCOMERC I	DATE 04/28/2008	MOLEX INCORPORATED DOCUMENT NO. SD-75594-001 SHEET NO. 1 OF 3			
2 PLACES ± 0.13	± ---	± ---	MATERIAL NO. 755940000							
1 PLACE ± 0.25	± ---	± ---	SIZE C		THIS DRAWING CONTAINS INFORMATION THAT IS PROPRIETARY TO MOLEX INCORPORATED AND SHOULD NOT BE USED WITHOUT WRITTEN PERMISSION					
DRAFT WHERE APPLICABLE MUST REMAIN WITHIN DIMENSIONS										

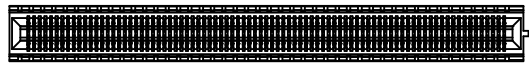

DAUGHTER CARD

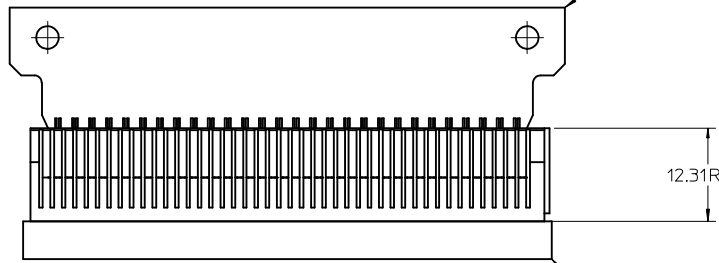

P.C. BOARD (BACKPLANE)

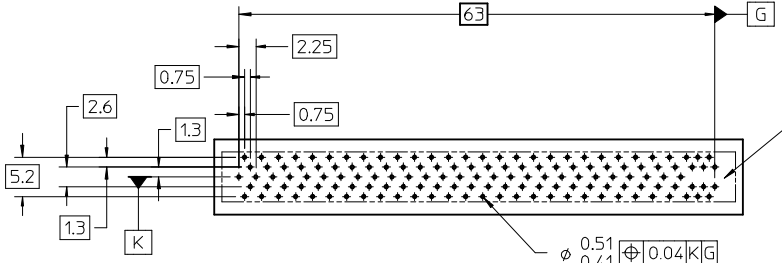
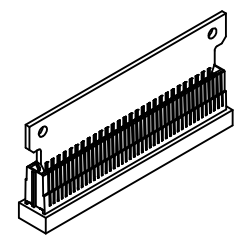
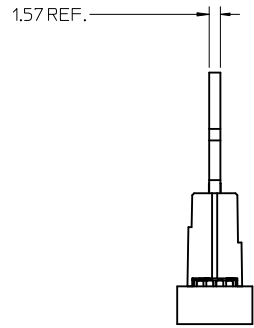

Note:
The holes located down the center are omitted within the last twelve circuit positions.
The center to center array remains constant.

ϕ 0.51
0.41 \oplus 0.04 K/G
FINISHED PLATED THRU HOLE SIZE
0.57 MM DRILLED HOLE SIZE
0.0254-0.0635 ELECTRO DEPOSITED COPPER

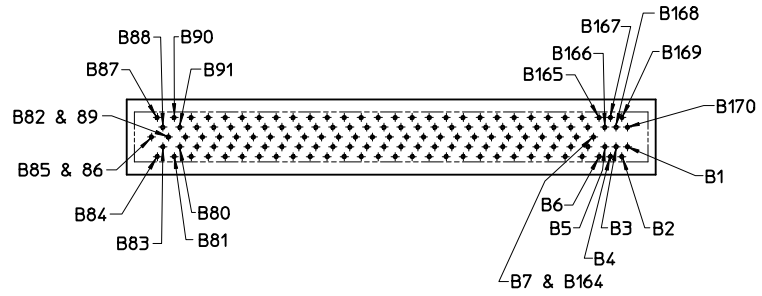

MOTHER BOARD HOLE LAYOUT

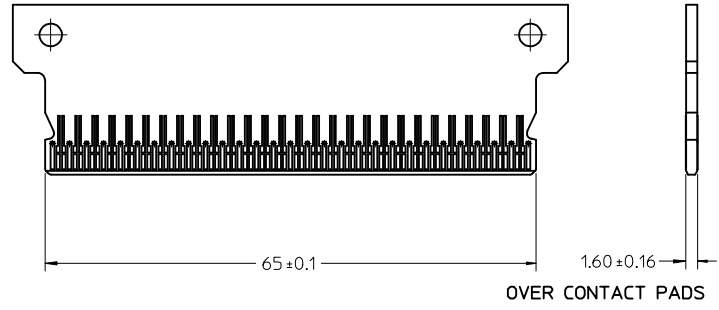

DAUGHTER CARD
SEE SPECIFICATION AMC.0 R2

SEE SHEET 1 IEC NO: UCP2009-2429 2009/05/18 DRWN:DROSCA 2009/05/20 CHKD: APPR: JCOMERC I 2009/05/20 REV:	QUALITY SYMBOLS	GENERAL TOLERANCES (UNLESS SPECIFIED)	DIMENSION STYLE	SCALE	DESIGN UNITS	THIRD ANGLE PROJECTION
	$\nabla=0$ $\nabla=0$	mm INCH	MM ONLY	1:1	METRIC	
		4 PLACES ± --- ± ---	DRAWN BY DATE	TITLE		
		3 PLACES ± --- ± ---	DROSCA 04/28/2008	SALES ASSEMBLY		
		2 PLACES ± 0.13 ± ---	CHECKED BY DATE	EDGE CARD, 75 MM PITCH		
	1 PLACE ± 0.25 ± ---	JCOMERC I 04/28/2008	170 CIRCUIT			
	ANGULAR ± 1/2°	APPROVED BY DATE	MOLEX INCORPORATED			
		JCOMERC I 04/28/2008	SD-75594-001			
		MATERIAL NO.	DOCUMENT NO.			
			SEE SHEET 1			
			SHEET NO. 2 OF 3			
			THIS DRAWING CONTAINS INFORMATION THAT IS PROPRIETARY TO MOLEX INCORPORATED AND SHOULD NOT BE USED WITHOUT WRITTEN PERMISSION			

75594-0000 LEGEND 170 CIRCUITS

COMPONENT SIDE 1					COMPONENT SIDE 2				
PIN NO.	SIGNAL	ALLEGRO PIN NO.			SIGNAL	PIN NO.			
170						1			
169		○	○	○	○	2			
168						3			
167		○	○	○	○	4			
166						5			
165		○	○	○	○	6			
164						7			
163		○	○	○	○	8			
162						9			
161		○	○	○	○	10			
160						11			
159		○	○	○	○	12			
158						13			
157		○	○	○	○	14			
156						15			
155		○	○	○	○	16			
154						17			
153		○	○	○	○	18			
152						19			
151		○	○	○	○	20			
150						21			
149		○	○	○	○	22			
148						23			
147		○	○	○	○	24			
146						25			
145		○	○	○	○	26			
144						27			
143		○	○	○	○	28			
142						29			
141		○	○	○	○	30			
140						31			
139		○	○	○	○	32			
138						33			
137		○	○	○	○	34			
136						35			
135		○	○	○	○	36			
134						37			
133		○	○	○	○	38			
132						39			
131		○	○	○	○	40			
130						41			
129		○	○	○	○	42			
128						43			
127		○	○	○	○	44			
126						45			
125		○	○	○	○	46			
124						47			
123		○	○	○	○	48			
122						49			
121		○	○	○	○	50			
120						51			
119		○	○	○	○	52			
118						53			
117		○	○	○	○	54			
116						55			
115		○	○	○	○	56			
114						57			
113		○	○	○	○	58			
112						59			
111		○	○	○	○	60			
110						61			
109		○	○	○	○	62			
108						63			
107		○	○	○	○	64			
106						65			
105		○	○	○	○	66			
104						67			
103		○	○	○	○	68			
102						69			
101		○	○	○	○	70			
100						71			
99		○	○	○	○	72			
98						73			
97		○	○	○	○	74			
96						75			
95		○	○	○	○	76			
94						77			
93		○	○	○	○	78			
92						79			
91		○	○	○	○	80			
90						81			
89		○	○	○	○	82			
88						83			
87		○	○	○	○	84			
86						85			

SEE SHEET 1 EC NO: UCP2009-2429 DRW: DROS CHKD: JCOMERCI APPR: JCOMERCI D1	QUALITY SYMBOLS = 0 = 0	GENERAL TOLERANCES (UNLESS SPECIFIED)		DIMENSION STYLE MM ONLY		SCALE 1:1	DESIGN UNITS METRIC	THIRD ANGLE PROJECTION		
						DRAWN BY DATE DROS CA 04/28/2008		TITLE SALES ASSEMBLY EDGE CARD, 75 MM PITCH 170 CIRCUIT		
						CHECKED BY DATE JCOMERCI 04/28/2008				
						APPROVED BY DATE JCOMERCI 04/28/2008		MOLEX INCORPORATED DOCUMENT NO. SD-75594-001		
				MATERIAL NO.		SHEET NO. 3 OF 3				
		DRAFT WHERE APPLICABLE MUST REMAIN WITHIN DIMENSIONS		SEE SHEET 1		THIS DRAWING CONTAINS INFORMATION THAT IS PROPRIETARY TO MOLEX INCORPORATED AND SHOULD NOT BE USED WITHOUT WRITTEN PERMISSION				

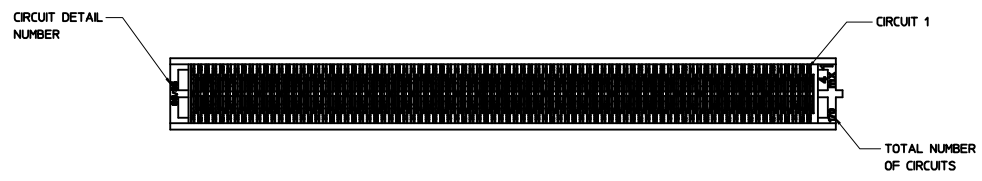
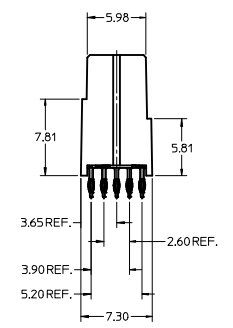
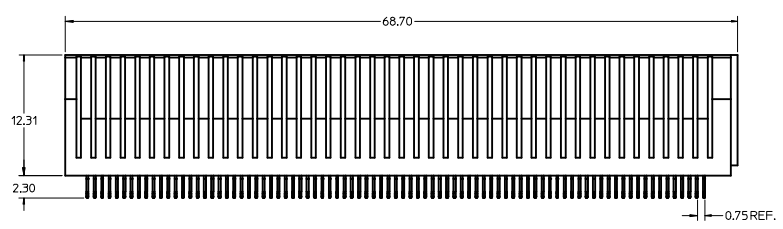
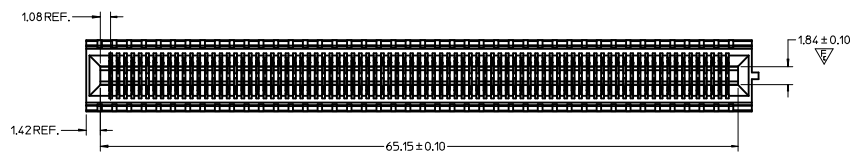

- NOTES:
- MATERIAL:
HOUSING - GLASS FILLED THERMOPLASTIC, 94-V0, BLACK
TERMINALS - COPPER ALLOY
 - FINISH:
TERMINALS - 0.76 MICRONS MINIMUM GOLD IN THE CONTACT AREA AND 0.76 - 152 MICRONS TIN IN PRESSFIT TAIL AREA OVER 1.27 MICRONS MINIMUM NICKEL OVERALL.
 - REFER TO PS-76421-001 PRODUCT SPECIFICATION FOR ALL ELECTRICAL, MECHANICAL AND ENVIRONMENTAL SPECIFICATIONS.
 - REFER TO PK-75594-999 FOR ALL PACKAGING SPECIFICATIONS.
 - PROCESSING: PRESSFIT TO PC BOARD.
 - MATING PC BOARD THICKNESS = 1.60±0.16MM OVER CONTACT PADS.
 - PRODUCT IS ELV AND RoHS COMPLIANT, LEVEL OF COMPLIANCE: 6/6
ALL BANNED SUBSTANCES ARE REMOVED:
Pb (LEAD)
HEXAVALENT CHROMIUM (CrVI)
CADMIUM
MERCURY
POLYBROMINATED BIPHENYL (PBB)
POLYBROMINATED DIPHENYL ETHER (PBDE)

INITIAL RELEASE EC NO: UCP2009-1091 DRAWN: DROSCA CHKD: JCOMERCI APPR: JCOMERCI REV DESCRIPTION	2008/12/05	2008/12/05	2008/12/09	QUALITY SYMBOLS	GENERAL TOLERANCES (UNLESS SPECIFIED)	DIMENSION STYLE	SCALE	DESIGN UNITS	THIRD ANGLE PROJECTION
				▽ = 0	mm INCH	MM ONLY	4:1	METRIC	
				▽ = 1	4 PLACES ± --- ± --- 3 PLACES ± --- ± --- 2 PLACES ± 0.13 ± --- 1 PLACE ± 0.25 ± ---	DRAWN BY DATE DROSCA 10/27/2008			TITLE EDGE LINE 12.5GB 0.062"PCB/0.75MM PITCH 170 CIRCUITS
				▽ = 1	ANGULAR ± 1/2°	CHECKED BY DATE JCOMERCI 10/27/2008			APPROVED BY DATE JCOMERCI 10/27/2008
				DRAFT WHERE APPLICABLE MUST REMAIN WITHIN DIMENSIONS	MATERIAL NO. 755940000	DOCUMENT NO. SD-75594-002			SHEET NO. 1 OF 5
					THIS DRAWING CONTAINS INFORMATION THAT IS PROPRIETARY TO MOLEX INCORPORATED AND SHOULD NOT BE USED WITHOUT WRITTEN PERMISSION				

P.C. BOARD MOUNTING

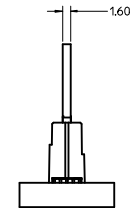
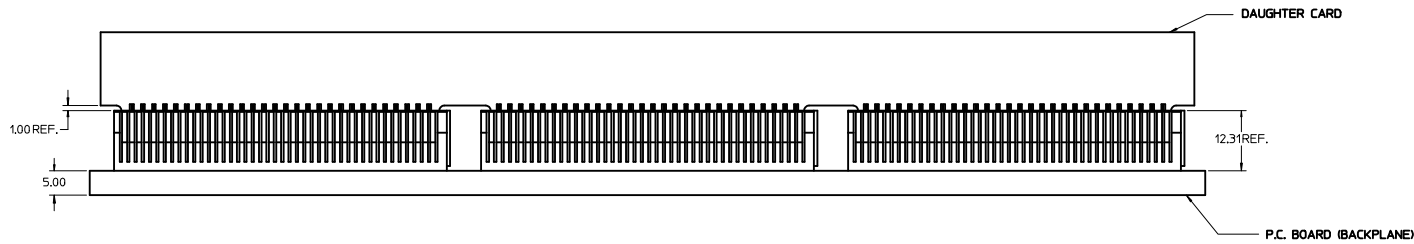

SEE SHEET 1 IEC NO: UCP2009-1091 DRAWN: DROSCA 2008/12/05 CHYK: 2008/12/05 APPR: JCOMERCI 2008/12/09	QUALITY SYMBOLS	DESCRIPTION	GENERAL TOLERANCES (UNLESS SPECIFIED)	DIMENSION STYLE	SCALE	DESIGN UNITS	THIRD ANGLE PROJECTION
	▽ - 0	4 PLACES	± ---	mm	MM ONLY	2:1	M
	▽ - 0	3 PLACES	± ---	INCH	DRAWN BY	DATE	TITLE
	▽ - 0	2 PLACES	± 0.13	± ---	DROSCA	10/27/2008	EDGE LINE 12.5GB 0.062"PCB/0.75MM PITCH 170 CIRCUITS
▽ - 0	1 PLACE	± 0.25	± ---	CHECKED BY	DATE	APPROVED BY	DATE
			ANGULAR ±1/2°	JCOMERCI	10/27/2008	JCOMERCI	10/27/2008
			DRAFT WHERE APPLICABLE MUST REMAIN WITHIN DIMENSIONS	WATERL NO.	DOCUMENT NO.		
				SEE SHEET 1	SD-75594-002		
				SIZE D	THIS DRAWING CONTAINS INFORMATION THAT IS PROPRIETARY TO MOLEX INCORPORATED AND SHOULD NOT BE USED WITHOUT WRITTEN PERMISSION		

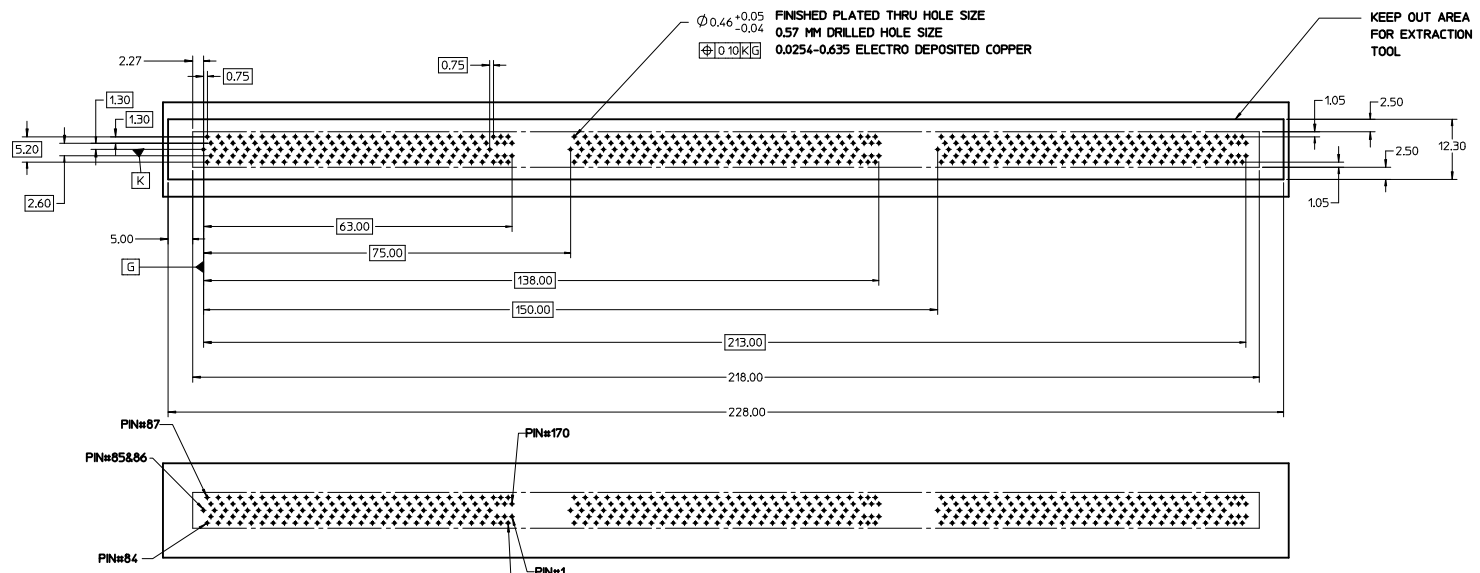

MOTHER BOARD HOLE LAYOUT
(COMPONENT SIDE)

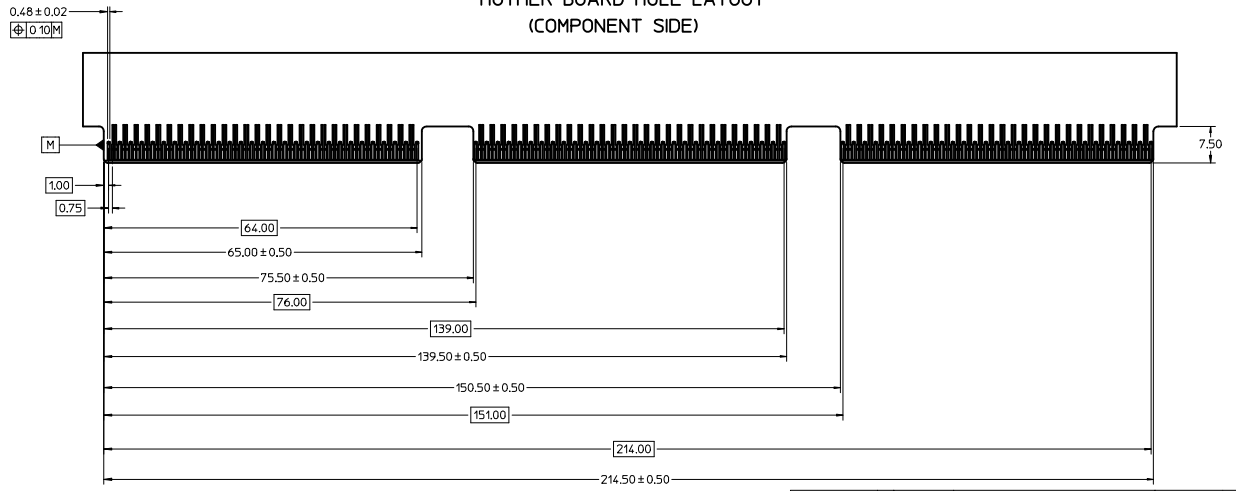

SEE SHEET 1 IEC NO: UCP2009-1091 DRAWN: DROSCA 2008/12/05 CHYK: 2008/12/05 APPR: JCOMERCI 2008/12/09	QUALITY SYMBOLS ▽=0 ▽=0	GENERAL TOLERANCES (UNLESS SPECIFIED) <table border="1"> <thead> <tr> <th></th> <th>mm</th> <th>INCH</th> </tr> </thead> <tbody> <tr> <td>4 PLACES</td> <td>± 0.13</td> <td>± 0.005</td> </tr> <tr> <td>3 PLACES</td> <td>± 0.25</td> <td>± 0.010</td> </tr> <tr> <td>2 PLACES</td> <td>± 0.38</td> <td>± 0.015</td> </tr> <tr> <td>1 PLACE</td> <td>± 0.51</td> <td>± 0.020</td> </tr> </tbody> </table>		mm	INCH	4 PLACES	± 0.13	± 0.005	3 PLACES	± 0.25	± 0.010	2 PLACES	± 0.38	± 0.015	1 PLACE	± 0.51	± 0.020	DIMENSION STYLE MM ONLY	SCALE 2:1	DESIGN UNITS METRIC	THIRD ANGLE PROJECTION
		mm	INCH																		
	4 PLACES	± 0.13	± 0.005																		
	3 PLACES	± 0.25	± 0.010																		
2 PLACES	± 0.38	± 0.015																			
1 PLACE	± 0.51	± 0.020																			
DRAWN BY DROSCA 10/27/2008	CHECKED BY DATE	APPROVED BY JCOMERCI 10/27/2008	MATERIAL NO. SEE SHEET 1	DOCUMENT NO. SD-75594-002	TITLE EDGE LINE 12.5GB 0.062"PCB/0.75MM PITCH 170 CIRCUITS	SHEET NO. 3 OF 5															
DRAFT WHERE APPLICABLE MUST REMAIN WITHIN DIMENSIONS			MOLEX INCORPORATED																		
THIS DRAWING CONTAINS INFORMATION THAT IS PROPRIETARY TO MOLEX INCORPORATED AND SHOULD NOT BE USED WITHOUT WRITTEN PERMISSION																					

MODULE EDGE CARD CONTACT DETAIL

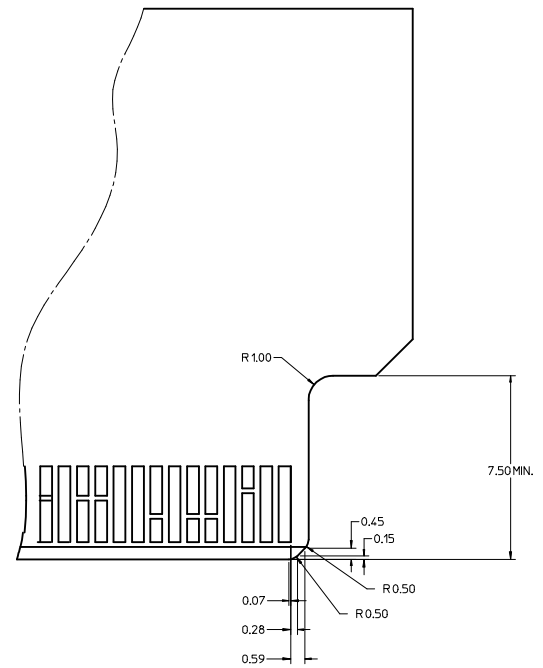
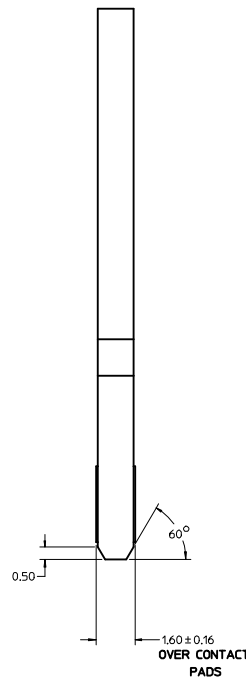
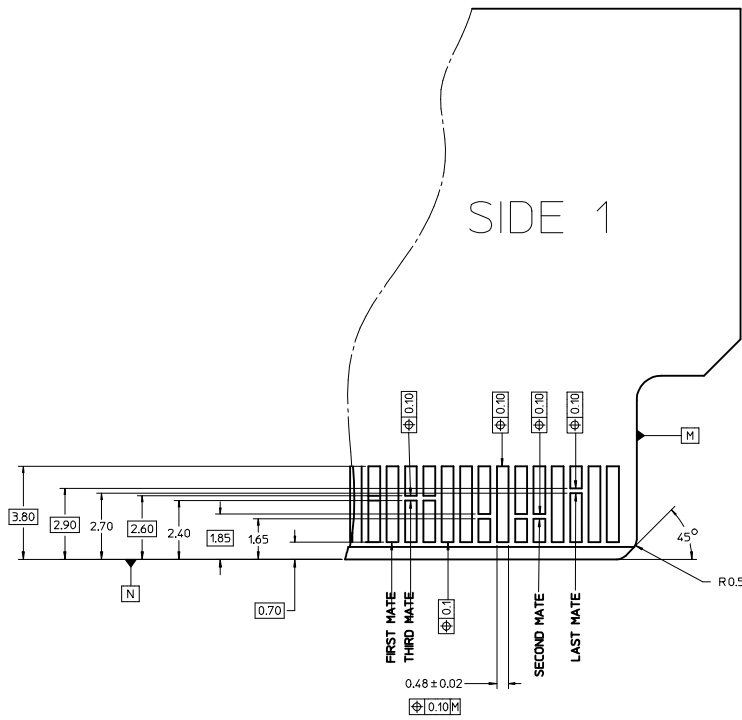

Note:

These are generic details that describe the configuration of various PCB design elements. The customer must determine where and when to use each element to accommodate their specific application.

SEE SHEET 1 IEC NO: UCP2009-1091 DRAWN: DROSCA 2008/12/05 CHKD: JCOMERCI 2008/12/05 APPR: JCOMERCI 2008/12/09	QUALITY SYMBOLS ▽=0 ▽=0	GENERAL TOLERANCES (UNLESS SPECIFIED)		DIMENSION STYLE MM ONLY	SCALE 10:1	DESIGN UNITS METRIC	THIRD ANGLE PROJECTION
		4 PLACES ± mm ± INCH 3 PLACES ± --- ± --- 2 PLACES ± 0.13 ± --- 1 PLACE ± 0.25 ± --- ANGULAR ± 1/2°	DRAWN BY DROSCA 10/27/2008 CHECKED BY JCOMERCI 10/27/2008 APPROVED BY JCOMERCI 10/27/2008	TITLE EDGE LINE 12.5GB 0.062"PCB/0.75MM PITCH 170 CIRCUITS		MATERIAL NO. SEE SHEET 1	
DRAFT WHERE APPLICABLE MUST REMAIN WITHIN DIMENSIONS		THIS DRAWING CONTAINS INFORMATION THAT IS PROPRIETARY TO MOLEX INCORPORATED AND SHOULD NOT BE USED WITHOUT WRITTEN PERMISSION					

LEGEND 170 CIRCUITS				
COMPONENT SIDE 1		ALLEGRO PIN NO.	COMPONENT SIDE 2	
PIN NO.	SIGNAL		SIGNAL	PIN NO.
920				1
919				2
918				3
917				4
916				5
915				6
914				7
913				8
912				9
911				10
910				11
909				12
908				13
907				14
906				15
905				16
904				17
903				18
902				19
901				20
900				21
899				22
898				23
897				24
896				25
895				26
894				27
893				28
892				29
891				30
890				31
889				32
888				33
887				34
886				35
885				36
884				37
883				38
882				39
881				40
880				41
879				42
878				43
877				44
876				45
875				46
874				47
873				48
872				49
871				50
870				51
869				52
868				53
867				54
866				55
865				56
864				57
863				58
862				59
861				60
860				61
859				62
858				63
857				64
856				65
855				66
854				67
853				68
852				69
851				70
850				71
849				72
848				73
847				74
846				75
845				76
844				77
843				78
842				79
841				80
840				81
839				82
838				83
837				84
836				85

SEE SHEET 1 IEC NO: UCP2009-1091 DRAWN: DROSCA 2008/12/05 CHYK: 2008/12/05 APPR: JCOMERCI 2008/12/09	QUALITY SYMBOLS ▽=0 ▽=0	GENERAL TOLERANCES (UNLESS SPECIFIED)		DIMENSION STYLE MM ONLY	SCALE 4:1	DESIGN UNITS METRIC	THIRD ANGLE PROJECTION		
		4 PLACES ± mm ± INCH 3 PLACES ± --- ± --- 2 PLACES ± 0.13 ± --- 1 PLACE ± 0.25 ± --- ANGULAR ±1/2°	DRAWN BY DROSCA 10/27/2008	CHECKED BY JCOMERCI 10/27/2008	APPROVED BY JCOMERCI 10/27/2008	TITLE EDGE LINE 12.5GB 0.062"PCB/0.75MM PITCH 170 CIRCUITS	MOLEX INCORPORATED		
		DRAFT WHERE APPLICABLE MUST REMAIN WITHIN DIMENSIONS	MATERIAL NO. SEE SHEET 1	DOCUMENT NO. SD-75594-002	SHEET NO. 5 OF 5	THIS DRAWING CONTAINS INFORMATION THAT IS PROPRIETARY TO MOLEX INCORPORATED AND SHOULD NOT BE USED WITHOUT WRITTEN PERMISSION			