



Chipsmall Limited consists of a professional team with an average of over 10 year of expertise in the distribution of electronic components. Based in Hongkong, we have already established firm and mutual-benefit business relationships with customers from,Europe,America and south Asia,supplying obsolete and hard-to-find components to meet their specific needs.

With the principle of “Quality Parts,Customers Priority,Honest Operation,and Considerate Service”,our business mainly focus on the distribution of electronic components. Line cards we deal with include Microchip,ALPS,ROHM,Xilinx,Pulse,ON,Everlight and Freescale. Main products comprise IC,Modules,Potentiometer,IC Socket,Relay,Connector.Our parts cover such applications as commercial,industrial, and automotives areas.

We are looking forward to setting up business relationship with you and hope to provide you with the best service and solution. Let us make a better world for our industry!



Contact us

Tel: +86-755-8981 8866 Fax: +86-755-8427 6832

Email & Skype: info@chipsmall.com Web: www.chipsmall.com

Address: A1208, Overseas Decoration Building, #122 Zhenhua RD., Futian, Shenzhen, China



RETENTION FIT SHELL

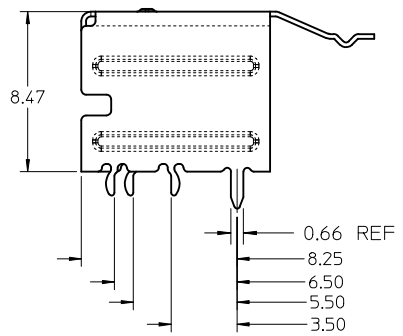
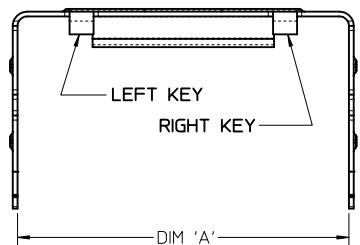
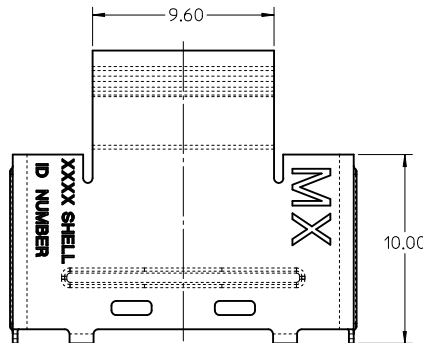
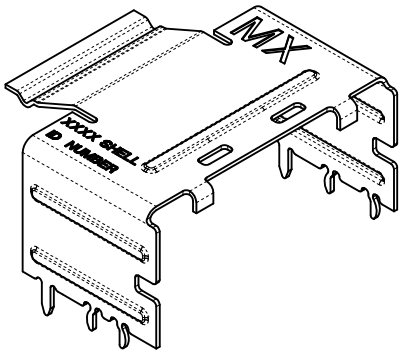

ITEM NUMBER	CIRCUIT SIZE	DIM 'A'	KEY
76010-5000	26	13.55	LEFT
76010-5010	26	13.55	RIGHT
76010-5020	26	13.55	DUAL
76010-5100	36	17.55	LEFT
76010-5110	36	17.55	RIGHT
76010-5120	36	17.55	DUAL
76010-5030	26	13.55	UNIVERSAL
76010-5130	36	17.55	UNIVERSAL
76010-5200	50	23.15	LEFT
76010-5210	50	23.15	RIGHT
76010-5220	50	23.15	DUAL
76010-5300	68	30.35	LEFT
76010-5310	68	30.35	RIGHT
76010-5320	68	30.35	DUAL
76010-5230	50	23.15	UNIVERSAL
76010-5330	68	30.35	UNIVERSAL

UNIVERSAL - NO KEY

- NOTES:
1. MATERIAL: SILVER NICKEL, THICKNESS: 0.250/0.254
 2. TO BE USED WITH CONNECTOR SERIES 75586, CABLE SERIES 79575/74563/79576/74573/79536/74562/74569/74586
 3. PACKAGED PER PACKAGING SPECIFICATION PK-76010-001
 4. DATE CODE WILL APPEAR ON SHIPPING CARTON ONLY

iPass™ IS A TRADEMARK OF MOLEX

ADD REF DIMENSION EC NO: UCP2012-1863 DRW:KLANG 2011/12/09 CHKD: APPR:MBANAKIS 2011/12/09	QUALITY SYMBOLS ▽=0 ▽=0	GENERAL TOLERANCES (UNLESS SPECIFIED)		DIMENSION STYLE MM ONLY	SCALE 5:1	DESIGN UNITS METRIC	THIRD ANGLE PROJECTION		
		4 PLACES ± --- ± --- 3 PLACES ± 0.13 ± --- 2 PLACES ± 0.13 ± --- 1 PLACE ± 0.25 ± ---	mm INCH	DRAWN BY JLSWENSON	DATE 2006/02/16	TITLE I-PASS SHELL RIGHT ANGLE INTERNAL CABLE			
		ANGULAR ±1/2°		CHECKED BY KLANG	DATE 2006/02/16	MOLEX MOLEX INCORPORATED			
		DRAFT WHERE APPLICABLE MUST REMAIN WITHIN DIMENSIONS		APPROVED BY MBANAKIS	DATE 2006/02/16	MATERIAL NO. SEE CHART	DOCUMENT NO. SD-76010-001	SHEET NO. 1 OF 7	

SMT SHELL

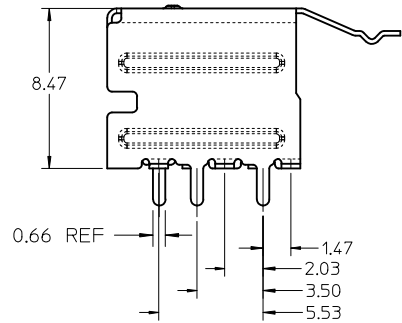
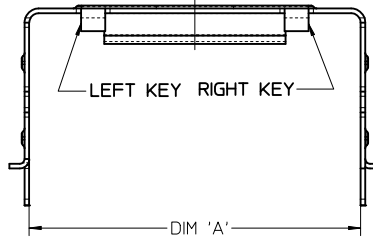
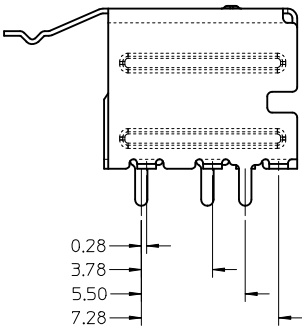
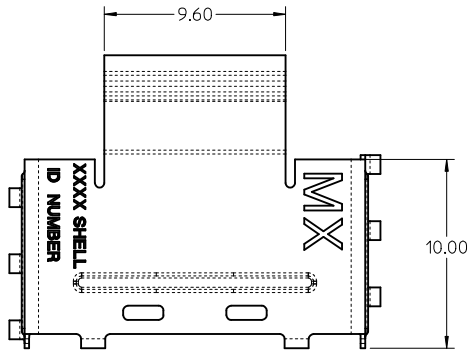
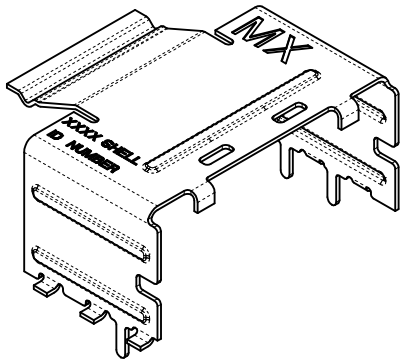

ITEM NUMBER	CIRCUIT SIZE	DIM 'A'	KEY
76010-5001	26	13.55	LEFT
76010-5011	26	13.55	RIGHT
76010-5021	26	13.55	DUAL
76010-5101	36	17.55	LEFT
76010-5111	36	17.55	RIGHT
76010-5121	36	17.55	DUAL
76010-5031	26	13.55	UNIVERSAL
76010-5131	36	17.55	UNIVERSAL
76010-5201	50	23.15	LEFT
76010-5211	50	23.15	RIGHT
76010-5221	50	23.15	DUAL
76010-5301	68	30.35	LEFT
76010-5311	68	30.35	RIGHT
76010-5321	68	30.35	DUAL
76010-5231	50	23.15	UNIVERSAL
76010-5331	68	30.35	UNIVERSAL

UNIVERSAL - NO KEY

iPass™ IS A TRADEMARK OF MOLEX

SEE SHEET 1 EC NO: UCP2012-1863 DRW:KLANG 2011/12/09 CHKD: APPR:MBANAKIS 2011/12/09	QUALITY SYMBOLS ▽=0 ▽=0	GENERAL TOLERANCES (UNLESS SPECIFIED) <table border="1"> <tr><th colspan="2">mm</th><th colspan="2">INCH</th></tr> <tr><td>4 PLACES</td><td>± .---</td><td>± .---</td><td></td></tr> <tr><td>3 PLACES</td><td>± 0.13</td><td>± .---</td><td></td></tr> <tr><td>2 PLACES</td><td>± 0.13</td><td>± .---</td><td></td></tr> <tr><td>1 PLACE</td><td>± 0.25</td><td>± .---</td><td></td></tr> </table> ANGULAR ±1/2°	mm		INCH		4 PLACES	± .---	± .---		3 PLACES	± 0.13	± .---		2 PLACES	± 0.13	± .---		1 PLACE	± 0.25	± .---		DIMENSION STYLE MM ONLY DRAWN BY: JLSWENSON DATE: 2006/02/16 CHECKED BY: KLANG DATE: 2006/02/16 APPROVED BY: MBANAKIS DATE: 2006/02/16 MATERIAL NO.	SCALE 5:1 DESIGN UNITS METRIC THIRD ANGLE PROJECTION	TITLE I-PASS SHELL RIGHT ANGLE INTERNAL CABLE	MOLEX MOLEX INCORPORATED	DOCUMENT NO. SD-76010-001	SHEET NO. 2 OF 7
	mm		INCH																									
	4 PLACES	± .---	± .---																									
	3 PLACES	± 0.13	± .---																									
2 PLACES	± 0.13	± .---																										
1 PLACE	± 0.25	± .---																										
DRAFT WHERE APPLICABLE MUST REMAIN WITHIN DIMENSIONS		SEE CHART	THIS DRAWING CONTAINS INFORMATION THAT IS PROPRIETARY TO MOLEX INCORPORATED AND SHOULD NOT BE USED WITHOUT WRITTEN PERMISSION																									

THROUGH HOLE SHELL (PART NUMBERS ON SHEET 4)

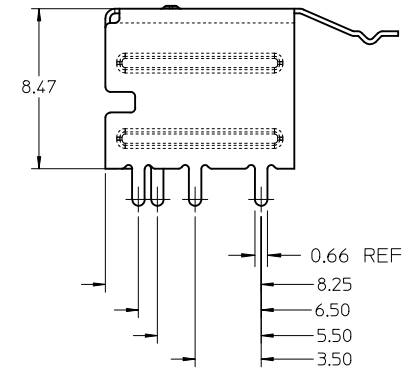
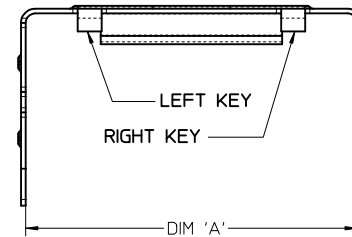
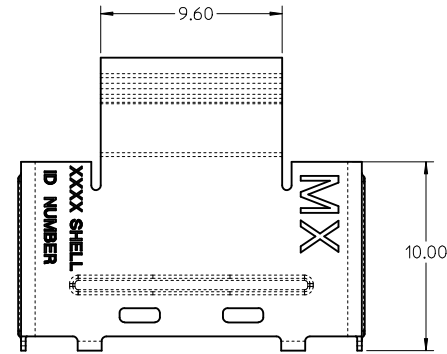
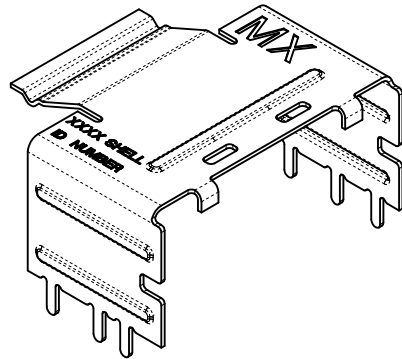

iPass™ IS A TRADEMARK OF MOLEX

SEE SHEET 1 EC NO: UCP2012-1863 DRW: KLANG 2011/12/09 CHKD: APPR: MBANAKIS 2011/12/09	QUALITY SYMBOLS ▽=0 ▽=0	GENERAL TOLERANCES (UNLESS SPECIFIED)		DIMENSION STYLE MM ONLY		SCALE 5:1	DESIGN UNITS METRIC	THIRD ANGLE PROJECTION		
		4 PLACES ± --- ± ---	DRAWN BY JLSWENSON	DATE 2006/02/16	TITLE I-PASS SHELL RIGHT ANGLE INTERNAL CABLE					
		3 PLACES ± 0.13 ± ---	CHECKED BY KLANG	DATE 2006/02/16	MOLEX MOLEX INCORPORATED					
		2 PLACES ± 0.13 ± ---	APPROVED BY MBANAKIS		DATE 2006/02/16	DOCUMENT NO. SD-76010-001		SHEET NO. 3 OF 7		
1 PLACE ± 0.25 ± ---	ANGULAR ± 1/2°		MATERIAL NO. SEE CHART		THIS DRAWING CONTAINS INFORMATION THAT IS PROPRIETARY TO MOLEX INCORPORATED AND SHOULD NOT BE USED WITHOUT WRITTEN PERMISSION					
DRAFT WHERE APPLICABLE MUST REMAIN WITHIN DIMENSIONS										

ITEM NUMBER	CIRCUIT SIZE	DIM 'A'	DIM 'B'	KEY
76010-5002	26	13.55	1.96	LEFT
76010-5012	26	13.55	1.96	RIGHT
76010-5022	26	13.55	1.96	DUAL
76010-5102	36	17.55	1.96	LEFT
76010-5112	36	17.55	1.96	RIGHT
76010-5122	36	17.55	1.96	DUAL
76010-5032	26	13.55	1.96	UNIVERSAL
76010-5132	36	17.55	1.96	UNIVERSAL
76010-5103	36	17.55	2.79	LEFT
76010-5113	36	17.55	2.79	RIGHT
76010-5123	36	17.55	2.79	DUAL
76010-5133	36	17.55	2.79	UNIVERSAL
76010-5104	36	17.55	3.18	LEFT
76010-5114	36	17.55	3.18	RIGHT
76010-5124	36	17.55	3.18	DUAL
76010-5134	36	17.55	3.18	UNIVERSAL
76010-5141	36	17.55	3.56	LEFT
76010-5151	36	17.55	3.56	RIGHT
76010-5161	36	17.55	3.56	DUAL
76010-5171	36	17.55	3.56	UNIVERSAL
76010-5202	50	23.15	1.96	LEFT
76010-5212	50	23.15	1.96	RIGHT
76010-5222	50	23.15	1.96	DUAL
76010-5302	68	30.35	1.96	LEFT
76010-5312	68	30.35	1.96	RIGHT
76010-5322	68	30.35	1.96	DUAL
76010-5232	50	23.15	1.96	UNIVERSAL
76010-5332	68	30.35	1.96	UNIVERSAL

ITEM NUMBER	CIRCUIT SIZE	DIM 'A'	DIM 'B'	KEY
76010-5003	26	13.55	2.79	LEFT
76010-5013	26	13.55	2.79	RIGHT
76010-5023	26	13.55	2.79	DUAL
76010-5033	26	13.55	2.79	UNIVERSAL
76010-5004	26	13.55	3.18	LEFT
76010-5014	26	13.55	3.18	RIGHT
76010-5024	26	13.55	3.18	DUAL
76010-5034	26	13.55	3.18	UNIVERSAL
76010-5203	50	23.15	2.79	LEFT
76010-5213	50	23.15	2.79	RIGHT
76010-5223	50	23.15	2.79	DUAL
76010-5233	50	23.15	2.79	UNIVERSAL
76010-5204	50	23.15	3.18	LEFT
76010-5214	50	23.15	3.18	RIGHT
76010-5224	50	23.15	3.18	DUAL
76010-5234	50	23.15	3.18	UNIVERSAL
76010-5303	68	30.35	2.79	LEFT
76010-5313	68	30.35	2.79	RIGHT
76010-5323	68	30.35	2.79	DUAL
76010-5333	68	30.35	2.79	UNIVERSAL
76010-5304	68	30.35	3.18	LEFT
76010-5314	68	30.35	3.18	RIGHT
76010-5324	68	30.35	3.18	DUAL
76010-5334	68	30.35	3.18	UNIVERSAL

UNIVERSAL = NO KEY

THROUGH HOLE SHELL (PART NUMBERS)

iPass™ IS A TRADEMARK OF MOLEX

SEE SHEET 1 EC NO: UCP2012-1863 DRW:KLANG 2011/12/09 CHKD: APPR:MBANAKIS 2011/12/09 REV: C1	QUALITY SYMBOLS 	GENERAL TOLERANCES (UNLESS SPECIFIED) <table border="1"> <tr> <th></th> <th>mm</th> <th>INCH</th> </tr> <tr> <td>4 PLACES</td> <td>± 0.13</td> <td>± 0.005</td> </tr> <tr> <td>3 PLACES</td> <td>± 0.13</td> <td>± 0.005</td> </tr> <tr> <td>2 PLACES</td> <td>± 0.13</td> <td>± 0.005</td> </tr> <tr> <td>1 PLACE</td> <td>± 0.25</td> <td>± 0.010</td> </tr> </table>		mm	INCH	4 PLACES	± 0.13	± 0.005	3 PLACES	± 0.13	± 0.005	2 PLACES	± 0.13	± 0.005	1 PLACE	± 0.25	± 0.010	DIMENSION STYLE MM ONLY	SCALE 5:1	DESIGN UNITS METRIC		TITLE I-PASS SHELL RIGHT ANGLE INTERNAL CABLE
		mm	INCH																			
	4 PLACES	± 0.13	± 0.005																			
	3 PLACES	± 0.13	± 0.005																			
2 PLACES	± 0.13	± 0.005																				
1 PLACE	± 0.25	± 0.010																				
DRAFT WHERE APPLICABLE MUST REMAIN WITHIN DIMENSIONS	DRAWN BY JLSWENSON	DATE 2006/02/16	CHECKED BY KLANG	DATE 2006/02/16	APPROVED BY MBANAKIS	DATE 2006/02/16																
SEE CHART	MATERIAL NO.	DOCUMENT NO.	MOLEX INCORPORATED	SD-76010-001	SHEET NO. 4 OF 7																	
SIZE C	THIS DRAWING CONTAINS INFORMATION THAT IS PROPRIETARY TO MOLEX INCORPORATED AND SHOULD NOT BE USED WITHOUT WRITTEN PERMISSION																					

RIGHT ANGLE RETENTION FIT AND THROUGH HOLE SHELL PCB FOOT PRINT

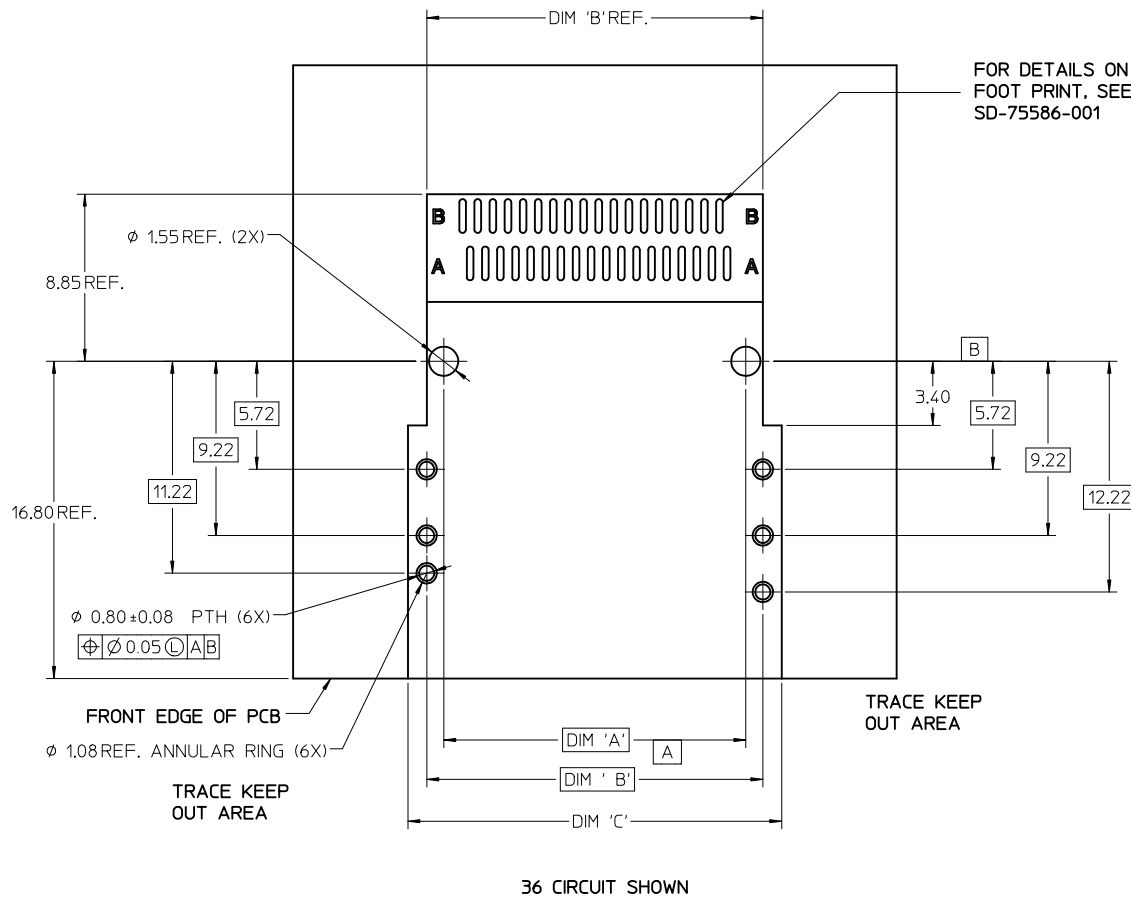

FOR DETAILS ON CONNECTOR
FOOT PRINT, SEE SALES DRAWING
SD-75586-001

CIRCUIT SIZE	CONNECTOR PEG TO PEG		
	DIM 'A'	DIM 'B'	DIM 'C'
26	12.00	13.80	16.80
36	16.00	17.80	20.80
50	21.60	23.40	25.40
68	28.80	30.60	32.60

iPass™ IS A TRADEMARK OF MOLEX

SEE SHEET 1 EC NO: UCP2012-1863 DRW:KLANG 2011/12/09 CHKD: APPR:MBANAKIS 2011/12/09	QUALITY SYMBOLS ▽=0 ▽=0	GENERAL TOLERANCES (UNLESS SPECIFIED)		DIMENSION STYLE MM ONLY	SCALE 5:1	DESIGN UNITS METRIC	THIRD ANGLE PROJECTION		
		mm	INCH	DRAWN BY JLSWENSON	DATE 2006/02/16	I-PASS SHELL RIGHT ANGLE INTERNAL CABLE			
		4 PLACES ± --- ± ---		CHECKED BY KLANG					
		3 PLACES ± 0.13 ± ---		APPROVED BY MBANAKIS		DATE 2006/02/16		MOLEX MOLEX INCORPORATED	
2 PLACES ± 0.13 ± ---		MATERIAL NO.		DOCUMENT NO.		SHEET NO.			
1 PLACE ± 0.25 ± ---		ANGULAR ± 1/2°		SEE CHART		SD-76010-001			
DRAFT WHERE APPLICABLE MUST REMAIN WITHIN DIMENSIONS		SIZE		THIS DRAWING CONTAINS INFORMATION THAT IS PROPRIETARY TO MOLEX INCORPORATED AND SHOULD NOT BE USED WITHOUT WRITTEN PERMISSION					
C1	REV					5 OF 7			

RIGHT ANGLE SMT SHELL PCB FOOT PRINT

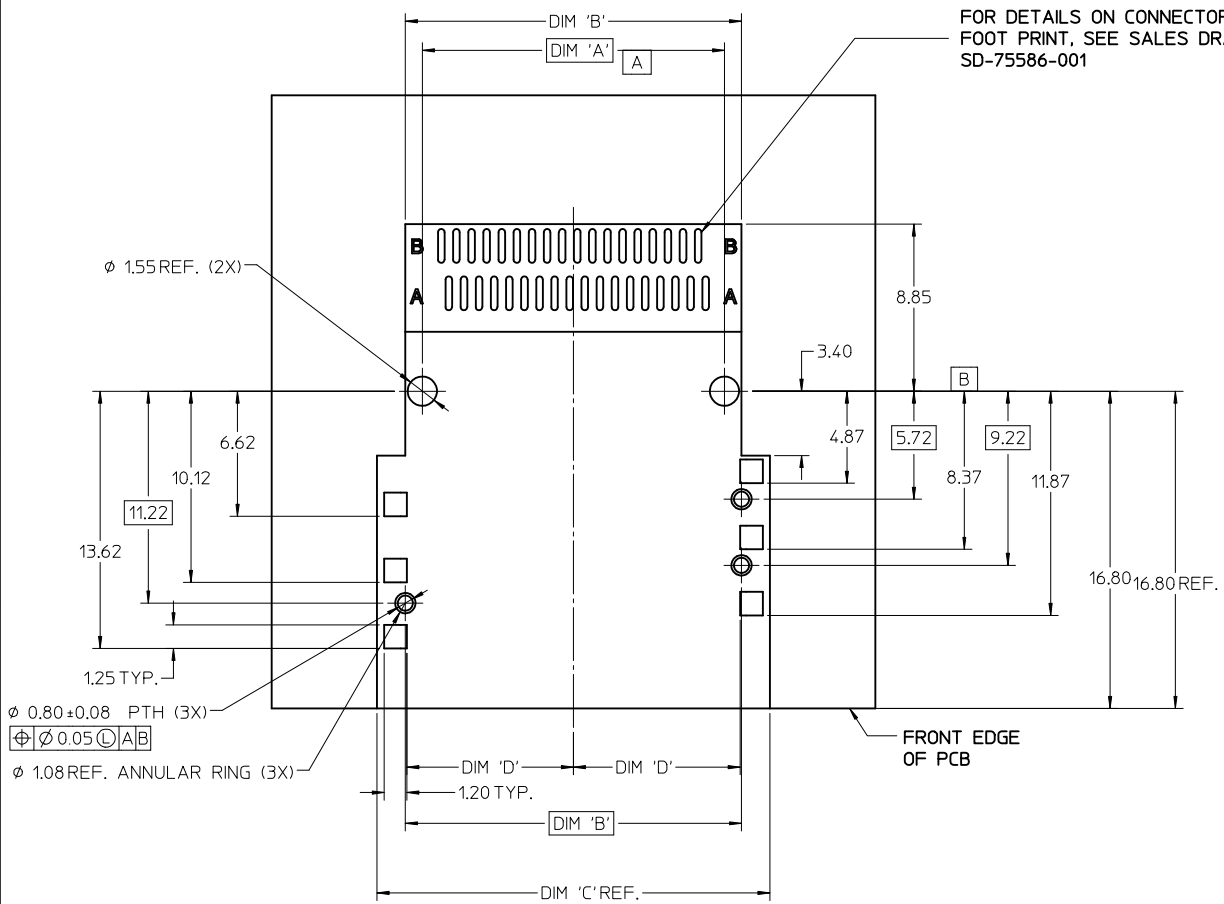

FOR DETAILS ON CONNECTOR
FOOT PRINT, SEE SALES DRAWING
SD-75586-001

CIRCUIT SIZE	<table border="1" style="width: 100%; text-align: center;"> <tr> <td style="width: 25%;">CONNECTOR PEG TO PEG</td> <td style="width: 25%;">SHELL PEG TO PEG</td> <td style="width: 25%;">SHELL FOOT PRINT WIDTH</td> <td style="width: 25%;">CENTERLINE TO PAD EDGE</td> </tr> </table>				CONNECTOR PEG TO PEG	SHELL PEG TO PEG	SHELL FOOT PRINT WIDTH	CENTERLINE TO PAD EDGE
	CONNECTOR PEG TO PEG	SHELL PEG TO PEG	SHELL FOOT PRINT WIDTH	CENTERLINE TO PAD EDGE				
DIM 'A'	DIM 'B'	DIM 'C'	DIM 'D'					
26	12.00	13.80	16.80	6.825				
36	16.00	17.80	20.80	8.825				
50	21.60	23.40	26.40	11.625				
68	28.80	30.60	33.60	15.225				

36 CIRCUIT SHOWN

iPass™ IS A TRADEMARK OF MOLEX

SEE SHEET 1 EC NO: UCP2012-1863 DRW: KLANG 2011/12/09 CHKD: APPR: MBANAKIS 2011/12/09 REV: C1	QUALITY SYMBOLS ▽=0 ▽=0	GENERAL TOLERANCES (UNLESS SPECIFIED) <table border="1" style="width: 100%; text-align: center;"> <tr> <th></th> <th>mm</th> <th>INCH</th> </tr> <tr> <td>4 PLACES</td> <td>± ---</td> <td>± ---</td> </tr> <tr> <td>3 PLACES</td> <td>± 0.13</td> <td>± ---</td> </tr> <tr> <td>2 PLACES</td> <td>± 0.13</td> <td>± ---</td> </tr> <tr> <td>1 PLACE</td> <td>± 0.25</td> <td>± ---</td> </tr> <tr> <td colspan="3">ANGULAR ± 1/2°</td> </tr> </table>		mm	INCH	4 PLACES	± ---	± ---	3 PLACES	± 0.13	± ---	2 PLACES	± 0.13	± ---	1 PLACE	± 0.25	± ---	ANGULAR ± 1/2°			DIMENSION STYLE MM ONLY DRAWN BY: JLSWENSON DATE: 2006/02/16 CHECKED BY: KLANG DATE: 2006/02/16 APPROVED BY: MBANAKIS DATE: 2006/02/16	SCALE 5:1	DESIGN UNITS METRIC	THIRD ANGLE PROJECTION	I-PASS SHELL RIGHT ANGLE INTERNAL CABLE
		mm	INCH																						
	4 PLACES	± ---	± ---																						
	3 PLACES	± 0.13	± ---																						
2 PLACES	± 0.13	± ---																							
1 PLACE	± 0.25	± ---																							
ANGULAR ± 1/2°																									
MOLEX INCORPORATED							SHEET NO. 6 OF 7																		
DRAFT WHERE APPLICABLE MUST REMAIN WITHIN DIMENSIONS							SEE CHART																		
THIS DRAWING CONTAINS INFORMATION THAT IS PROPRIETARY TO MOLEX INCORPORATED AND SHOULD NOT BE USED WITHOUT WRITTEN PERMISSION							DOCUMENT NO. SD-76010-001																		

RIGHT ANGLE SHELL PCB FOOT PRINT DESCRIPTIONS

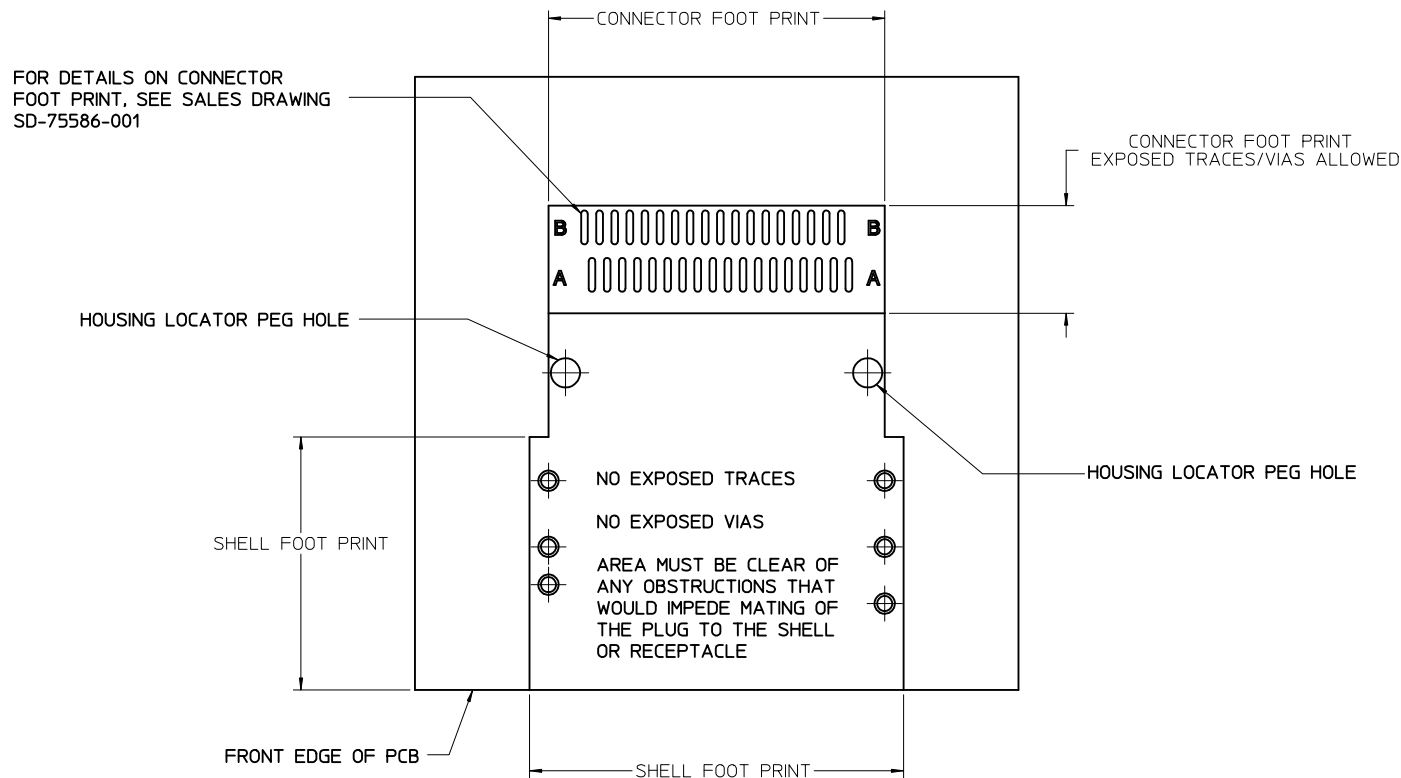

NOTE: IF RECEPTACLE AND SHELL ARE NOT PLACED AT EDGE OF PCB AS SHOWN, ADDITIONAL CLEARANCE IS NEEDED FOR BODY OF PLUG AND CABLE

iPass™ IS A TRADEMARK OF MOLEX

SEE SHEET 1 EC NO: UCP2012-1863 DRW: KLANG 2011/12/09 CHKD: MBANAKIS APPR: MBANAKIS 2011/12/09	QUALITY SYMBOLS	GENERAL TOLERANCES (UNLESS SPECIFIED)	DIMENSION STYLE	SCALE	DESIGN UNITS	THIRD ANGLE PROJECTION
	▽=0 ▽=0	mm INCH 4 PLACES ± --- ± --- 3 PLACES ± 0.13 ± --- 2 PLACES ± 0.13 ± --- 1 PLACE ± 0.25 ± --- ANGULAR ± 1/2°	MM ONLY	5:1	METRIC	
	DESCRIPTION	DRAFT WHERE APPLICABLE MUST REMAIN WITHIN DIMENSIONS	DRAWN BY DATE JLSWENSON 2006/02/16 CHECKED BY DATE KLANG 2006/02/16 APPROVED BY DATE MBANAKIS 2006/02/16	TITLE I-PASS SHELL RIGHT ANGLE INTERNAL CABLE		
	REV		SEE CHART	MOLEX MOLEX INCORPORATED DOCUMENT NO. SD-76010-001		SHEET NO. 7 OF 7