



Chipsmall Limited consists of a professional team with an average of over 10 year of expertise in the distribution of electronic components. Based in Hongkong, we have already established firm and mutual-benefit business relationships with customers from,Europe,America and south Asia,supplying obsolete and hard-to-find components to meet their specific needs.

With the principle of "Quality Parts,Customers Priority,Honest Operation,and Considerate Service",our business mainly focus on the distribution of electronic components. Line cards we deal with include Microchip,ALPS,ROHM,Xilinx,Pulse,ON,Everlight and Freescale. Main products comprise IC,Modules,Potentiometer,IC Socket,Relay,Connector.Our parts cover such applications as commercial,industrial, and automotives areas.

We are looking forward to setting up business relationship with you and hope to provide you with the best service and solution. Let us make a better world for our industry!



Contact us

Tel: +86-755-8981 8866 Fax: +86-755-8427 6832

Email & Skype: info@chipsmall.com Web: www.chipsmall.com

Address: A1208, Overseas Decoration Building, #122 Zhenhua RD., Futian, Shenzhen, China



10 9 8 7 6 5 4 3 2 1

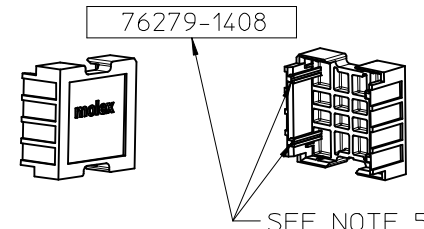
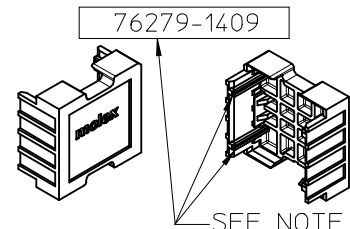
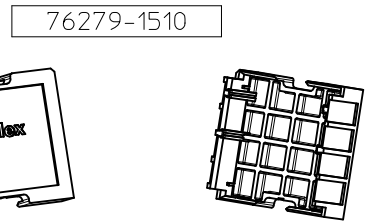
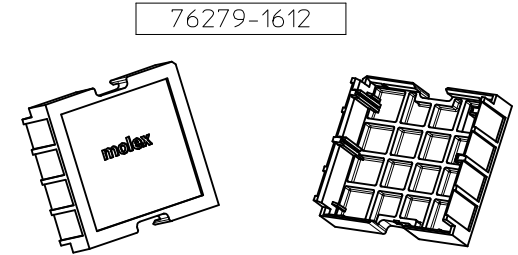
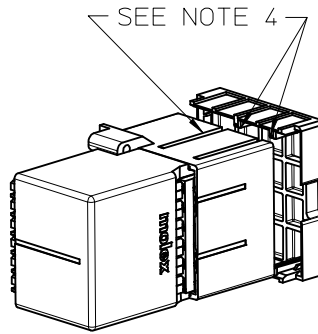
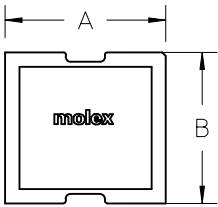
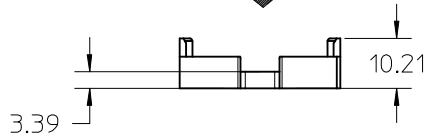
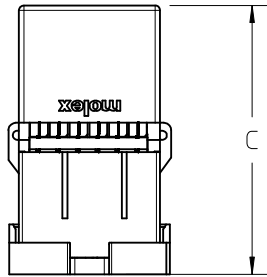
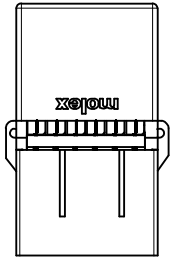

- NOTES:
- MATERIAL: ABS
COLOR: NATURAL (WHITE)
 - COVERS FIT BOTH GUIDED AND UNGUIDED CONFIGURATIONS.
 - THIS PART CONFORMS TO CLASS B REQUIREMENTS OF COSMETIC SPEC PS-45499-002
 - INTERNAL COVER RIBS ALIGN WITH SLOTS ON CONNECTOR HOUSING
 - ONLY MATES WITH TWO SLOT 4 PAIR OD-RAM
 - PLEASE SEE RAS-76279-9999 FOR DUST COVER USAGE AND REAPPLICATION GUIDELINES.

PART NUMBER	NUMBER OF PAIRS	NUMBER OF COLUMNS	DIM "A"	DIM "B"	DIM "C"
76279-1612	6 PAIR	12 COLUMN	32.9	30.9	55
76279-1510	5 PAIR	10 COLUMN	27.9	26.9	50
76279-1408	4 PAIR	8 COLUMN	23.8	22.8	46
76279-1409	4 PAIR/TOP GUIDE	8 COLUMN			

ADD 76279-1409 EC NO: UCP2015-3274 DRWN:BJ MILLER 2015/01/12 CHKD: APPR:TELO 2015/02/12 REV A	QUALITY SYMBOLS	GENERAL TOLERANCES (UNLESS SPECIFIED)	DIMENSION STYLE	SCALE	DESIGN UNITS	THIRD ANGLE PROJECTION
	▽/0	mm INCH	MM ONLY	1:1	METRIC	
	▽/0	4 PLACES ± --- ± ---	DRAWN BY DATE	TITLE IMPACT ORTHOGONAL DIRECT PROTECTIVE DUST COVERS		
	▽/0	3 PLACES ± --- ± ---	BJ MILLER 2013/08/09			
	2 PLACES ± 0.13 ± ---	CHECKED BY DATE	DOCUMENT NO. SD-76279-1612			
	1 PLACE ± 0.25 ± ---	APPROVED BY DATE				
	0 PLACE ± --- ± ---	TELO 2015/02/12	SHEET NO. 1 OF 1			
ANGULAR ± 1/2°		MATERIAL NO.				
DRAFT WHERE APPLICABLE		SEE CHART	THIS DRAWING CONTAINS INFORMATION THAT IS PROPRIETARY TO MOLEX INCORPORATED AND SHOULD NOT BE USED WITHOUT WRITTEN PERMISSION			
MUST REMAIN WITHIN DIMENSIONS		SIZE B				

9 8 7 6 5 4 3 2 1