



Chipsmall Limited consists of a professional team with an average of over 10 year of expertise in the distribution of electronic components. Based in Hongkong, we have already established firm and mutual-benefit business relationships with customers from,Europe,America and south Asia,supplying obsolete and hard-to-find components to meet their specific needs.

With the principle of “Quality Parts,Customers Priority,Honest Operation,and Considerate Service”,our business mainly focus on the distribution of electronic components. Line cards we deal with include Microchip,ALPS,ROHM,Xilinx,Pulse,ON,Everlight and Freescale. Main products comprise IC,Modules,Potentiometer,IC Socket,Relay,Connector.Our parts cover such applications as commercial,industrial, and automotives areas.

We are looking forward to setting up business relationship with you and hope to provide you with the best service and solution. Let us make a better world for our industry!



Contact us

Tel: +86-755-8981 8866 Fax: +86-755-8427 6832

Email & Skype: info@chipsmall.com Web: www.chipsmall.com

Address: A1208, Overseas Decoration Building, #122 Zhenhua RD., Futian, Shenzhen, China



10 9 8 7 6 5 4 3 2 1

F

E

D

C

B

A

F

E

D

C

B

A

NOTE:

- MATERIAL: HOUSING : LIQUID CRYSTAL POLYMER, GLASS FILLED, UL94-V0, COLOR: BLACK
TERMINAL : PHOSPHOR BRONZE
METAL SHELL : STAINLESS STEEL
- FINISH:
TERMINAL:-
CONTACT : 0.38µM MIN. GOLD OVER 1.27µM MIN NICKEL UNDERPLATE.
SOLDERTAIL: 1.27µM MIN. MATTE TIN OVER 1.27µM MIN NICKEL UNDERPLATE.
SHELL :-
: NO PLATING
- PRODUCT SPECIFICATION: PS-78800-001
PACKAGING SPECIFICATION: PK-78800-001
- SOLDERTAIL (10X) COPLANARITY 0.08MM MAX (BEFORE REFLOW).
- CAVITY NUMBER LOCATION.
- COMPLIANT TO RoHS DIRECTIVE 2011/65/EU AND ELV DIRECTIVE 2000/53/EC
- MANUFACTURER ID AND DATE CODE LOCATION.
DATE CODE ON SHELL : * * * * *

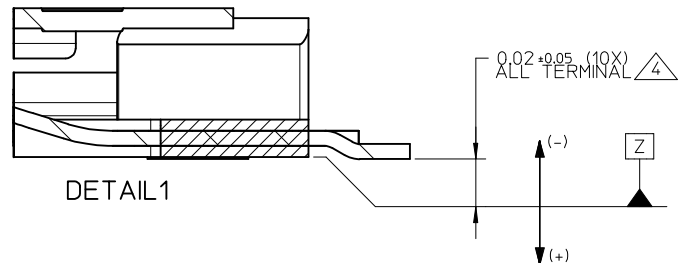
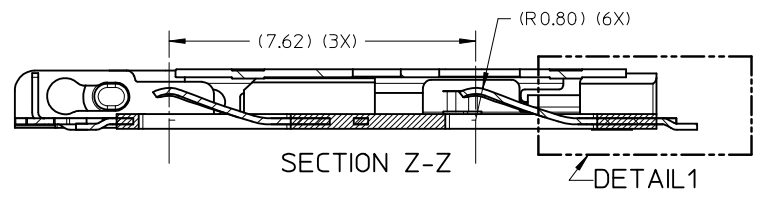
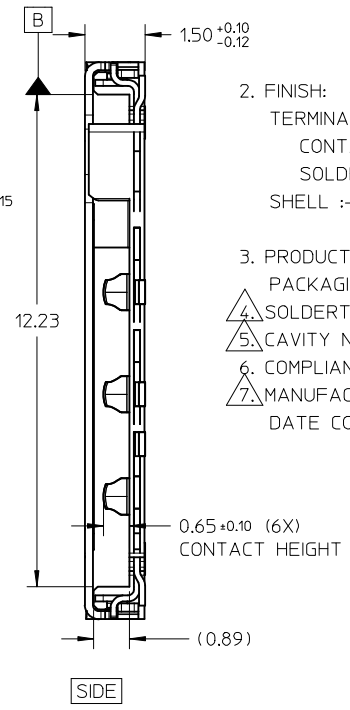
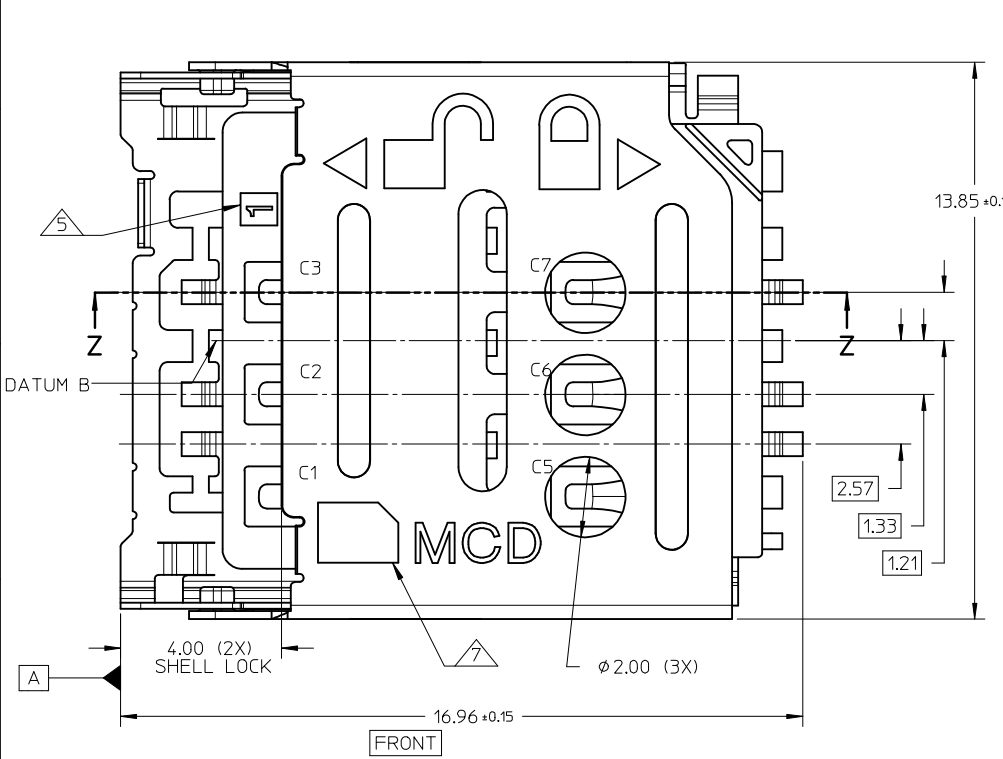
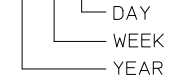

UPDATE VIEWS EC NO: S2015-0120 DRW: EANG CHKD: JTAN02 APPR: KHL IM	QUALITY SYMBOLS $F_A=0$ $F_C=0$ $F_P=0$	GENERAL TOLERANCES (UNLESS SPECIFIED) mm INCH 4 PLACES ± --- ± --- 3 PLACES ± --- ± --- 2 PLACES ± 0.20 ± --- 1 PLACE ± --- ± --- 0 PLACE ± --- ± --- ANGULAR ± 3 °	DIMENSION STYLE MM ONLY DRAWN BY: EANG DATE: 2012/11/29 CHECKED BY: JTAN02 DATE: 2013/03/11 APPROVED BY: KHL IM DATE: 2013/03/14	SCALE: NTS DESIGN UNITS: METRIC THIRD ANGLE PROJECTION	TITLE: SALES DRAWING MICRO SIM CONNECTOR 1.50MM HEIGHT, HINGED molex	MATERIAL NO.: 788000001 DOCUMENT NO.: SD-78800-001 SHEET NO.: 1 OF 3
	DRAFT WHERE APPLICABLE MUST REMAIN WITHIN DIMENSIONS	THIS DRAWING CONTAINS INFORMATION THAT IS PROPRIETARY TO MOLEX INCORPORATED AND SHOULD NOT BE USED WITHOUT WRITTEN PERMISSION				
	SIZE: A3					
	REV: A					

9 8 7 6 5 4 3 2 1

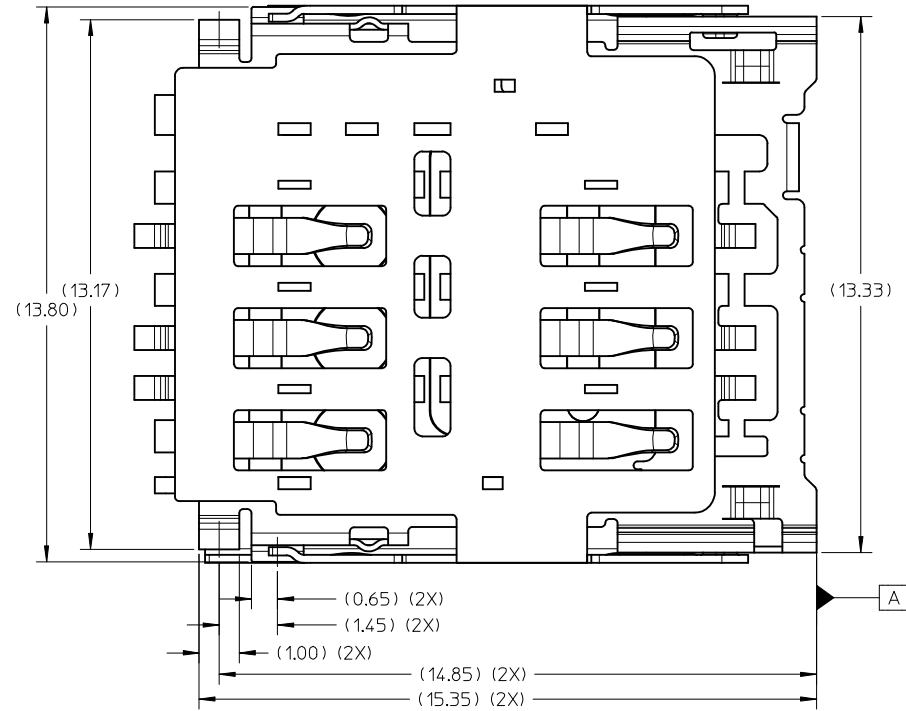
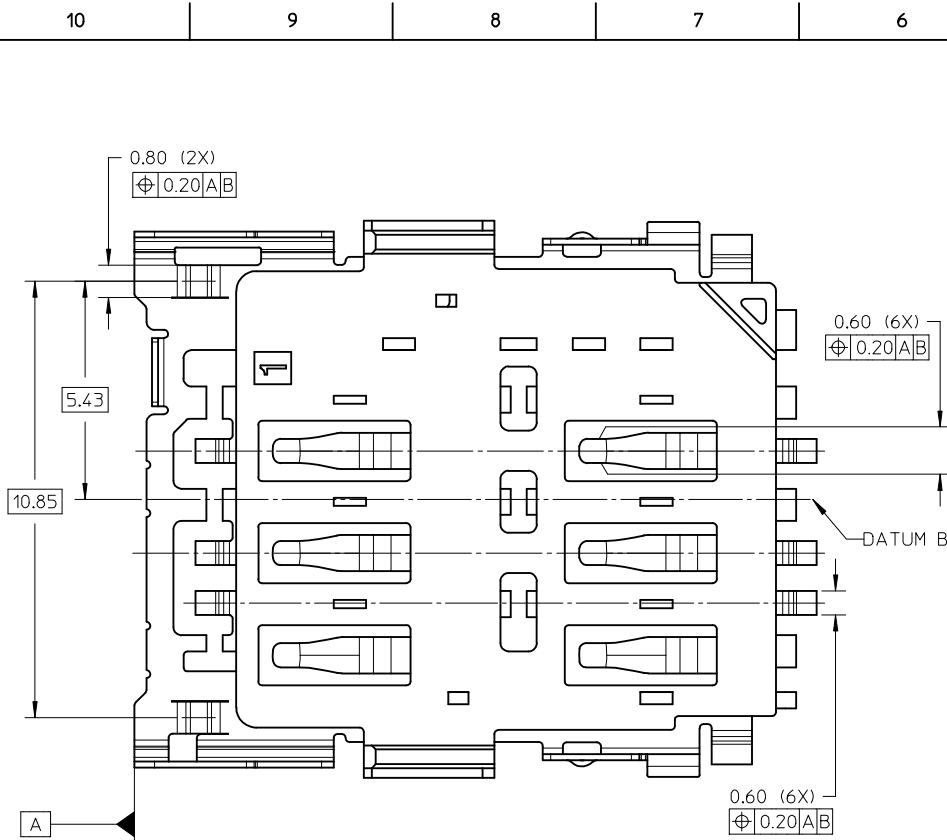

BOTTOM VIEW

UPDATE VIEWS IEC NO: S2015-0120 DRW: EANG CH: KD: JTAN02 APPR: KHL IM	2015/06/26	2015/08/26	2015/08/27	QUALITY SYMBOLS $\nabla = 0$ $\nabla = 0$ $\nabla = 0$	GENERAL TOLERANCES (UNLESS SPECIFIED)		DIMENSION STYLE MM ONLY		SCALE NTS	DESIGN UNITS METRIC	THIRD ANGLE PROJECTION	
					4 PLACES	± ---	± ---	DRAWN BY EANG	DATE 2012/11/29	TITLE SALES DRAWING MICRO SIM CONNECTOR 1.50MM HEIGHT, HINGED		
					3 PLACES	± ---	± ---	CHECKED BY JTAN02	DATE 2013/03/11			
					2 PLACES	± 0.20	± ---	APPROVED BY KHL IM	DATE 2013/03/14	MATERIAL NO. 788000001	DOCUMENT NO. SD-78800-001	SHEET NO. 2 OF 3
			1 PLACE	± ---	± ---	ANGULAR ± 3 °		THIS DRAWING CONTAINS INFORMATION THAT IS PROPRIETARY TO MOLEX INCORPORATED AND SHOULD NOT BE USED WITHOUT WRITTEN PERMISSION				
			0 PLACE	± ---	± ---	DRAFT WHERE APPLICABLE MUST REMAIN WITHIN DIMENSIONS						

10 9 8 7 6 5 4 3 2 1

F

E

D

C

B

A

F

E

D

C

B

A

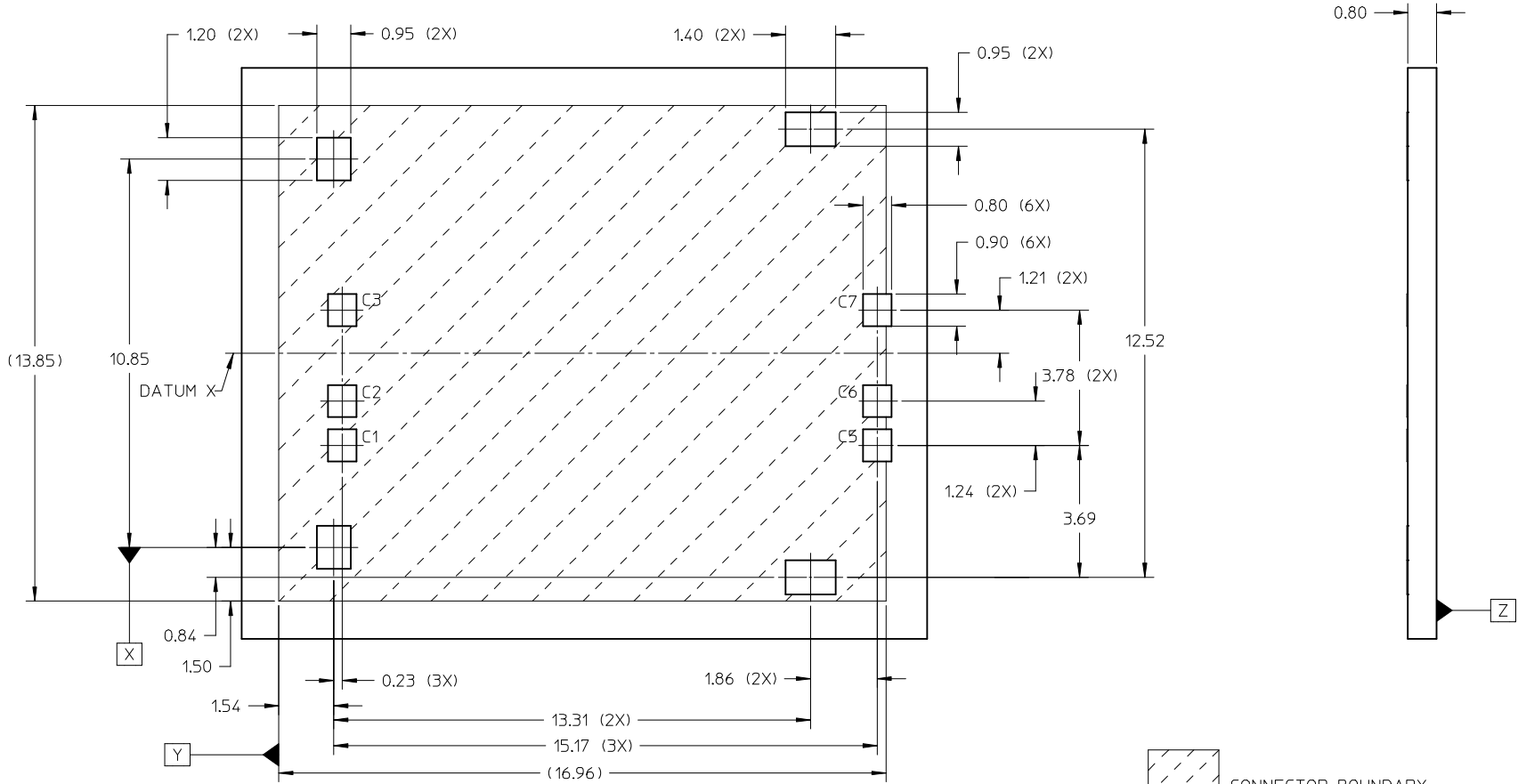

CONNECTOR BOUNDARY

----- KEEP OUT ZONE

RECOMMENDED PCB LAYOUT
PWB TOLERANCE: ±0.05MM

UPDATE VIEWS EC NO: S2015-0120 DRW: EANG CHKD: JTAN02 APPR: KHL IM	2015/06/26 2015/08/26 2015/08/27	DESCRIPTION REV	QUALITY SYMBOLS $\nabla_A = 0$ $\nabla_C = 0$ $\nabla_P = 0$	GENERAL TOLERANCES (UNLESS SPECIFIED)		DIMENSION STYLE MM ONLY		SCALE NTS	DESIGN UNITS METRIC	THIRD ANGLE PROJECTION		
			4 PLACES ± --- ± --- 3 PLACES ± --- ± --- 2 PLACES ± 0.20 ± --- 1 PLACE ± --- ± --- 0 PLACE ± --- ± ---	mm INCH	DRAWN BY EANG	DATE 2012/11/29	TITLE SALES DRAWING MICRO SIM CONNECTOR 1.50MM HEIGHT, HINGED					
			DRAFT WHERE APPLICABLE MUST REMAIN WITHIN DIMENSIONS		CHECKED BY JTAN02	DATE 2013/03/11	MATERIAL NO. 788000001				DOCUMENT NO. SD-78800-001	SHEET NO. 3 OF 3
					APPROVED BY KHL IM	DATE 2013/03/14	THIS DRAWING CONTAINS INFORMATION THAT IS PROPRIETARY TO MOLEX INCORPORATED AND SHOULD NOT BE USED WITHOUT WRITTEN PERMISSION					

9 8 7 6 5 4 3 2 1