



Chipsmall Limited consists of a professional team with an average of over 10 year of expertise in the distribution of electronic components. Based in Hongkong, we have already established firm and mutual-benefit business relationships with customers from,Europe,America and south Asia,supplying obsolete and hard-to-find components to meet their specific needs.

With the principle of “Quality Parts,Customers Priority,Honest Operation,and Considerate Service”,our business mainly focus on the distribution of electronic components. Line cards we deal with include Microchip,ALPS,ROHM,Xilinx,Pulse,ON,Everlight and Freescale. Main products comprise IC,Modules,Potentiometer,IC Socket,Relay,Connector.Our parts cover such applications as commercial,industrial, and automotives areas.

We are looking forward to setting up business relationship with you and hope to provide you with the best service and solution. Let us make a better world for our industry!



Contact us

Tel: +86-755-8981 8866 Fax: +86-755-8427 6832

Email & Skype: info@chipsmall.com Web: www.chipsmall.com

Address: A1208, Overseas Decoration Building, #122 Zhenhua RD., Futian, Shenzhen, China



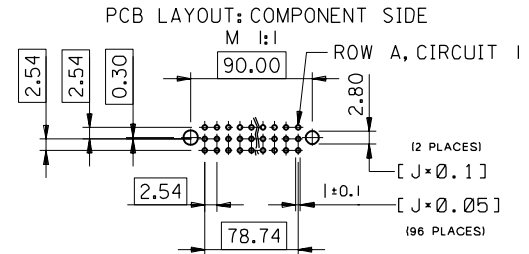
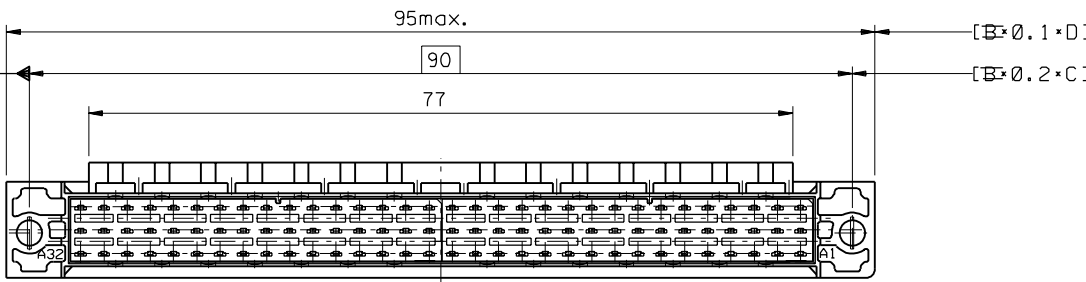

l) tails to fit in PC-board layout

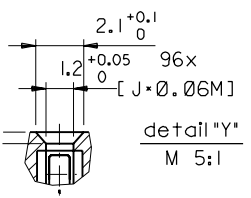
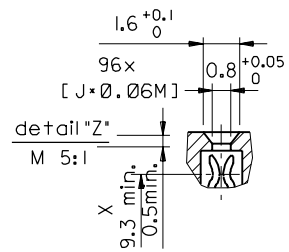
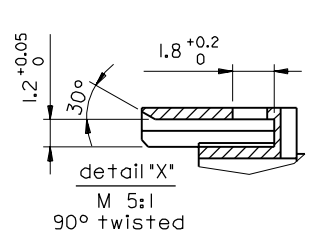
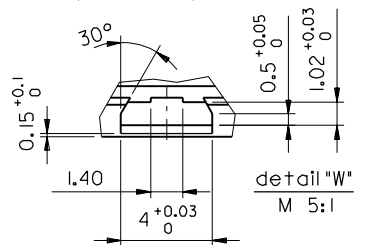
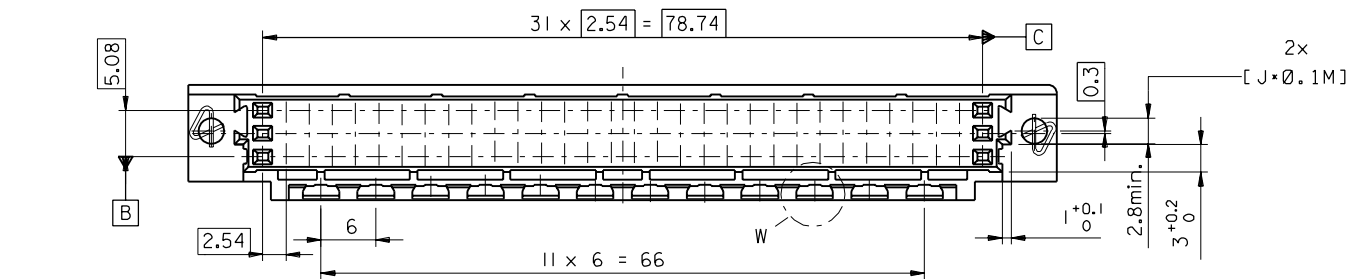
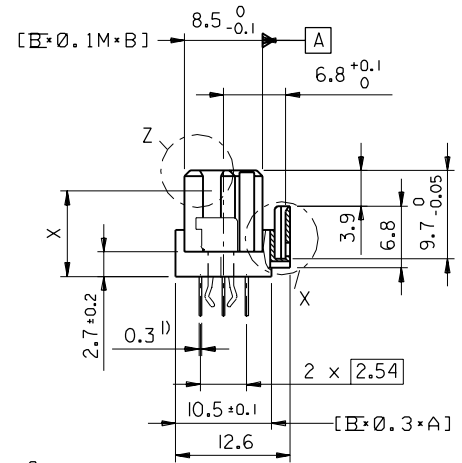
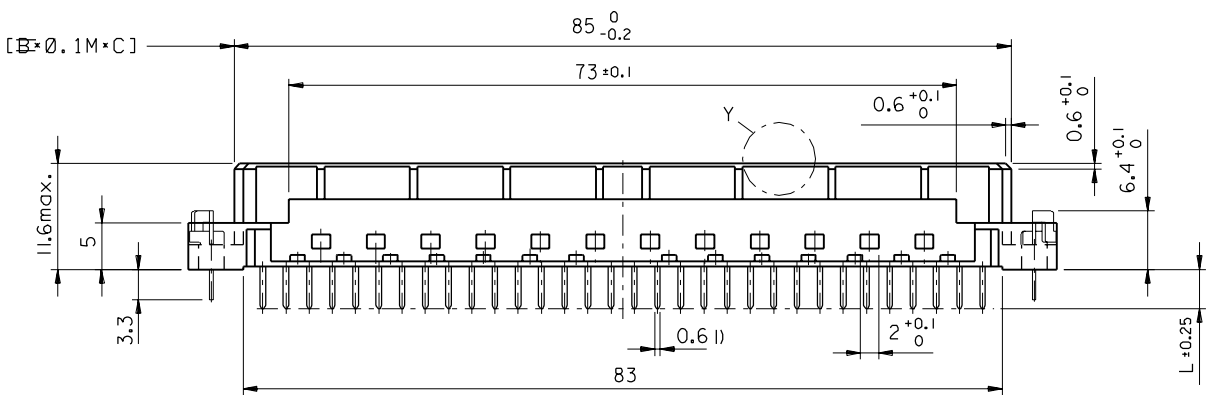

FIRST ANGLE PROJECTION

REVISE ONLY ON CAD SYSTEM

ECN MG1998-2583
Schraege, Lochbild
97-09-17 KN

REVISIONS	3 PLACE ±	±
	2 PLACE ±	±
	1 PLACE ±	±
DRAFT WHERE APPLICABLE MUST REMAIN WITHIN DIMENSIONS		
DESIGN DIMENSION	<input checked="" type="checkbox"/> MM	<input type="checkbox"/> IN.
EQUIVALENT DIMENSION	<input type="checkbox"/> MM	<input type="checkbox"/> IN.
IF TWO DIMENSIONS ARE SHOWN THE UPPER IS THE DESIGN DIMENSION, LOWER IS SECONDARY		

DRWG BY: KN
CHK'D BY: Ca
APP'D BY: JB
SCALE: 2:1

CAD/CAM PROJECT NAME: 85042000 s12
THIS DRAWING CONTAINS INFORMATION THAT IS PROPRIETARY TO MOLEX INC. & SHOULD NOT BE USED WITHOUT WRITTEN PERMISSION

TITLE: 96 pos. female connector
DIN 41612 style C, + clip
with coding, dimensions

MOLEX MOLEX EUROPE
SHEET NO. DATE: 2 OF 2 96/04/30
PART NO.: SDA-85042-0001
DWG NO.:
SIZE: B

