



Chipsmall Limited consists of a professional team with an average of over 10 year of expertise in the distribution of electronic components. Based in Hongkong, we have already established firm and mutual-benefit business relationships with customers from,Europe,America and south Asia,supplying obsolete and hard-to-find components to meet their specific needs.

With the principle of “Quality Parts,Customers Priority,Honest Operation,and Considerate Service”,our business mainly focus on the distribution of electronic components. Line cards we deal with include Microchip,ALPS,ROHM,Xilinx,Pulse,ON,Everlight and Freescale. Main products comprise IC,Modules,Potentiometer,IC Socket,Relay,Connector.Our parts cover such applications as commercial,industrial, and automotives areas.

We are looking forward to setting up business relationship with you and hope to provide you with the best service and solution. Let us make a better world for our industry!



Contact us

Tel: +86-755-8981 8866 Fax: +86-755-8427 6832

Email & Skype: info@chipsmall.com Web: www.chipsmall.com

Address: A1208, Overseas Decoration Building, #122 Zhenhua RD., Futian, Shenzhen, China



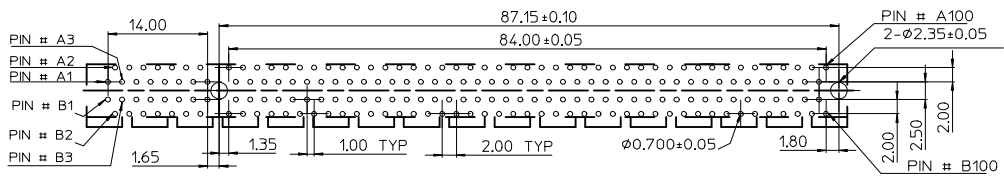
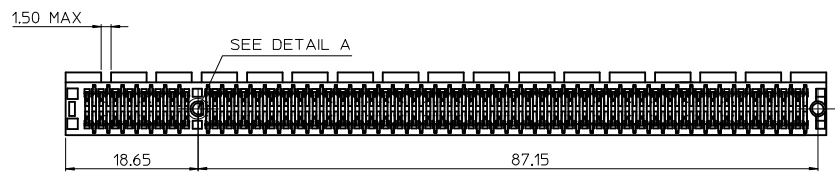
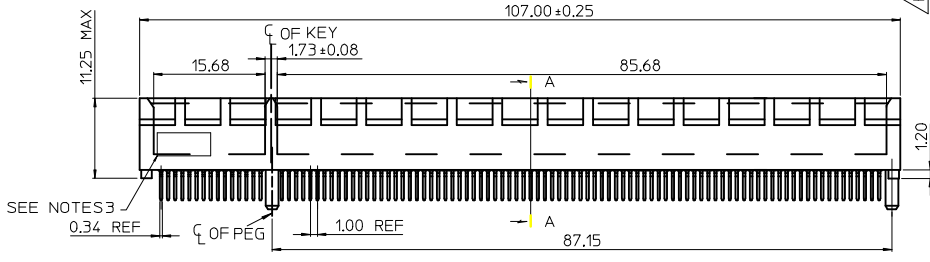
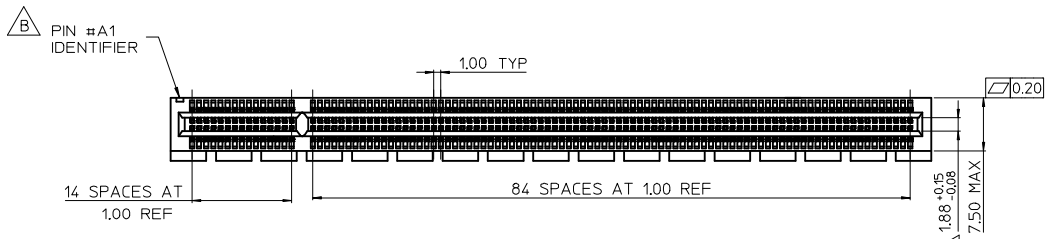

MOLEX P/N	CIRCUIT SIZE	HOUSING MATERIAL	HOUSING COLOR	TERMINAL MATERIAL	CONTACT PLATING	SOLDERTAIL PLATING	DIM "B"
87715-9920	200	NYLON46	BLACK	PHOSPHOR BRONZE	GOLD 30 MICROINCH	100 MICROINCH TIN OVER NICKEL OVERALL	2.54
87715-9921							3.00

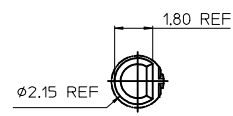

DETAIL A

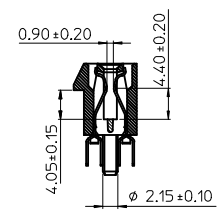
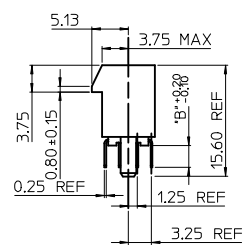

SECTION A-A

△ NOTES:

- MATERIALS:
 - HOUSING:SEE TABLE, GLASS FIBER FILLED, UL94V-0, COLOR:SEE TABLE
 - CONTACT:SEE TABLE
- PLATING:
 - CONTACT AREA:SEE TABLE
 - SOLDER TAIL:SEE TABLE
 - UNDER PLATING:SEE TABLE
- DATE CODE:TO BE PRINTED
- PRODUCT SPECIFICATION REFER TO PS-87715-200
- PACKAGING SPECIFICATION REFER TO PK-87715-212
- TEST SUMMARY:REFER TO TS-87715-212
- LEAD-FREE AND ROHS COMPLIANT PRODUCT

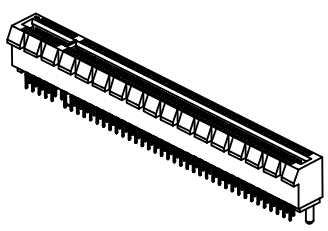

DRAWING ERROR EC NO: SH2007-0602 DRWN:ALL IN 2007/02/14 CHKD: 2007/02/14 APPR:WMSCHANG 2007/02/14	QUALITY SYMBOLS ▽=0 ▽=0	GENERAL TOLERANCES (UNLESS SPECIFIED)		DIMENSION STYLE MM ONLY		SCALE	DESIGN UNITS METRIC	THIRD ANGLE PROJECTION △ 1.00 PITCH EDGE CARD 200 PIN VERT DIP CONN	
			mm	INCH	DRAWN BY	DATE	TITLE		
		4 PLACES ± --- ± ---	3 PLACES ± --- ± ---	2 PLACES ± 0.25 ± ---	1 PLACE ± 0.25 ± ---	TOM	2005/03/13	WILSON CHANG	2005/03/13
		ANGULAR ± 3 °				APPROVED BY		DATE	
DRAFT WHERE APPLICABLE MUST REMAIN WITHIN DIMENSIONS				WILSON CHANG		2005/03/13		MOLEX INCORPORATED DOCUMENT NO. SD-87715-212 SHEET NO. 1 OF 2	
				MATERIAL NO.		SEE TABLE			
				THIS DRAWING CONTAINS INFORMATION THAT IS PROPRIETARY TO MOLEX INCORPORATED AND SHOULD NOT BE USED WITHOUT WRITTEN PERMISSION					

7 6 5 4 3 2 1

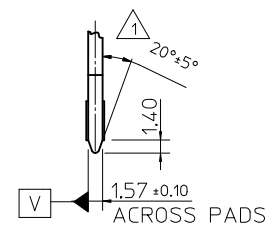
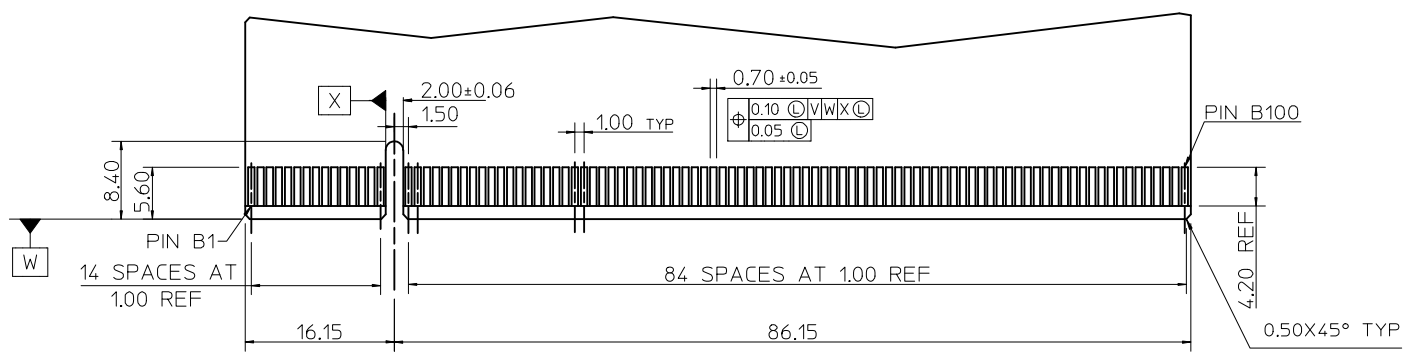

← I/O PANEL DIRECTION
 △ PRIMARY (COMPONENT) SIDE

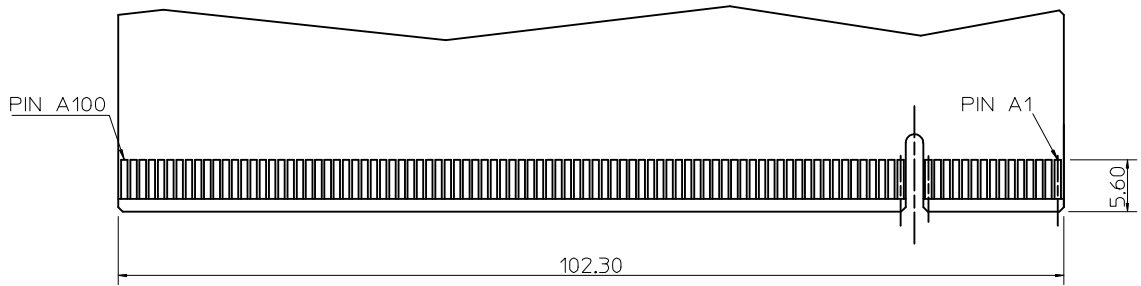

I/O PANEL → DIRECTION
 SECONDARY (SOLDER) SIDE

NOTES :
 △ CHAMFER EDGES MUST BE FREE OF CUTTING BURRS.

SEE SHEET 1 EC NO: SH2007-0602 2007/02/14 DRWN: ALL IN 2007/02/14 CHKD: 2007/02/14 APPR: WMSCHANG 2007/02/14	QUALITY SYMBOLS	GENERAL TOLERANCES (UNLESS SPECIFIED)		DIMENSION STYLE MM ONLY		SCALE 1:1	DESIGN UNITS METRIC	THIRD ANGLE PROJECTION	
	▽=0	mm	INCH	DRAWN BY	DATE	TITLE △ 1.00 PITCH EDGE CARD 200 PIN VERT DIP CONN			
	∇=0	4 PLACES ± ---	± ---	TOM	2005/03/13				
		3 PLACES ± ---	± ---	CHECKED BY	DATE	MOLEX MOLEX INCORPORATED			
		2 PLACES ± 0.25	± ---	ALLEN LIN	2005/03/13				
	1 PLACE ± 0.25	± ---	APPROVED BY	DATE	DOCUMENT NO. SD-87715-212		SHEET NO. 2 OF 2		
		ANGULAR ± 3 °		MATERIAL NO. SEE TABLE		THIS DRAWING CONTAINS INFORMATION THAT IS PROPRIETARY TO MOLEX INCORPORATED AND SHOULD NOT BE USED WITHOUT WRITTEN PERMISSION			
		DRAFT WHERE APPLICABLE MUST REMAIN WITHIN DIMENSIONS							

6 5 4 3 2 1