



Chipsmall Limited consists of a professional team with an average of over 10 year of expertise in the distribution of electronic components. Based in Hongkong, we have already established firm and mutual-benefit business relationships with customers from,Europe,America and south Asia,supplying obsolete and hard-to-find components to meet their specific needs.

With the principle of “Quality Parts,Customers Priority,Honest Operation,and Considerate Service”,our business mainly focus on the distribution of electronic components. Line cards we deal with include Microchip,ALPS,ROHM,Xilinx,Pulse,ON,Everlight and Freescale. Main products comprise IC,Modules,Potentiometer,IC Socket,Relay,Connector.Our parts cover such applications as commercial,industrial, and automotives areas.

We are looking forward to setting up business relationship with you and hope to provide you with the best service and solution. Let us make a better world for our industry!



Contact us

Tel: +86-755-8981 8866 Fax: +86-755-8427 6832

Email & Skype: info@chipsmall.com Web: www.chipsmall.com

Address: A1208, Overseas Decoration Building, #122 Zhenhua RD., Futian, Shenzhen, China



NOTES:

1. MATERIAL:
HSG: NYLON, GLASS-FILLED, UL94V-0 COLOR: BLACK
PIN: 0.50MM SQ, COPPER ALLOY

2. PLATING FINISH:

- (1) 0.38µm MIN. GOLD OVER
1.25µm MIN. NICKEL OVERALL.
- (2) GOLD FLASH ON CONTACT AND
2.50µm MIN. TIN ON SOLDER TAIL OVER
1.25µm MIN. NICKEL OVERALL.
- (3) 0.38µm MIN. GOLD PLATE ON CONTACT AND
2.00µm MIN. TIN ON SOLDER TAIL OVER
1.25µm MIN. NICKEL OVERALL.
- (4) 0.75µm MIN. GOLD PLATE ON CONTACT AND
2.00µm MIN. TIN ON SOLDER TAIL OVER
1.25µm MIN. NICKEL OVERALL.
- (5) 2.50µm MIN. TIN OVERALL
1.25µm MIN. NICKEL OVERALL.
- (6) 0.38µm MIN. GOLD PLATE ON CONTACT AND
0.05µm MIN. GOLD ON SOLDER TAIL OVER
1.25µm MIN. NICKEL OVERALL.
- (7) 0.75µm MIN. GOLD PLATE ON CONTACT AND
0.05µm MIN. GOLD ON SOLDER TAIL OVER
1.25µm MIN. NICKEL OVERALL.
- (8) 0.75µm MIN. GOLD OVERALL
1.25µm MIN. NICKEL OVERALL.
- (9) 0.05µm MIN. GOLD OVERALL
1.25µm MIN. NICKEL OVERALL.

- 3. PIN PUSHOUT FORCE: 0.85Kgf MIN IN EITHER DIRECTION.
- 4. THE ABOVE 16CKTS SHOWN IS FOR ILLUSTRATION ONLY.
- 5. FOR PACKING OPTION PLEASE REFER TO THE TABLE.
- 6. IRREGULAR CIRCUIT CUTOFF WITHIN BREAKAWAY SECTION IS PERMISSIBLE. CUTTING OR CHIPPING OF THE MAIN BODY IS NOT ACCEPTABLE
- 7. PRODUCT SPEC PS-87761-001 APPLIES.
- 8. RECOMMENDED PCB THICKNESS 1.60MM.
- 9. WAFER TO BE FLAT WITHIN 0.003 mm/mm
- 10. PACKAGING SPECIFICATION:
TRAY: PK-89990-487
BULK: PK-89990-490
TUBE: PK-89990-475

11. WHEN WAFER ARE STACK TOGETHER, DIMENSION 'H' SHOULD BE TAKEN AS REFERENCE.

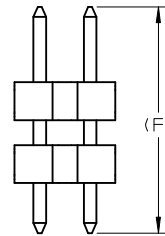
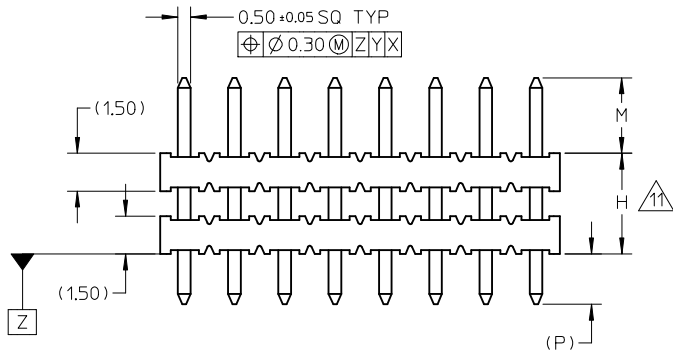
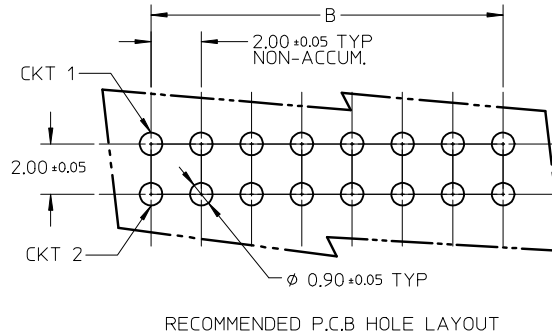
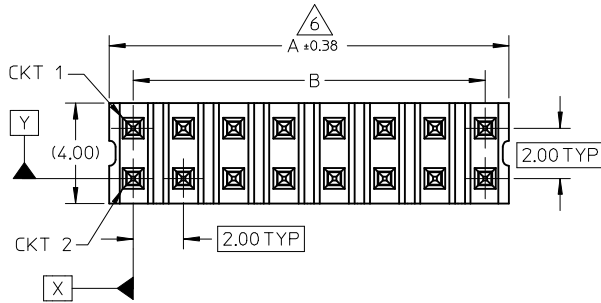

REVISION OF DRAWINGS MAYBE CHANGED DURING FINAL RELEASED FOR PRODUCTION

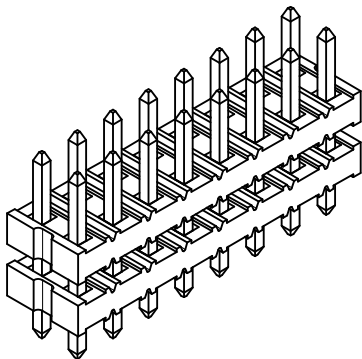

ADD P/N: 87761-4001 EC NO: S2012-0955 DRWN: SKANG 2012/06/26 CHKD: ATSEE 2012/07/16 APPR: MLONG 2012/07/17	QUALITY SYMBOLS $\nabla F = 0$ $\nabla F = 0$ $\nabla F = 0$	GENERAL TOLERANCES (UNLESS SPECIFIED)		DIMENSION STYLE MM ONLY		SCALE NTS	DESIGN UNITS METRIC	THIRD ANGLE PROJECTION		
			mm	INCH	DRAWN BY	DATE	TITLE 2MM DUAL ROW DUAL WAFER HEADER, VERTICAL T/H			
		4 PLACES	± ---	± ---	KCHO	2005/02/23				
		3 PLACES	± ---	± ---	CHECKED BY	DATE				
			2 PLACES	± 0.20	± ---	PTL IM	2005/04/26			
			1 PLACE	± ---	± ---	APPROVED BY	DATE			
			ANGULAR ± 3 °		MLONG	2010/11/11				
			DRAFT WHERE APPLICABLE MUST REMAIN WITHIN DIMENSIONS		MATERIAL NO.	DOCUMENT NO.		SHEET NO.		
					SEE TABLE	SD-87761-052		1 OF 3		
					SIZE A3	THIS DRAWING CONTAINS INFORMATION THAT IS PROPRIETARY TO MOLEX INCORPORATED AND SHOULD NOT BE USED WITHOUT WRITTEN PERMISSION				

CKT SIZE	DIMENSION	
	A	B
04	4.00	2.00
06	6.00	4.00
08	8.00	6.00
10	10.00	8.00
12	12.00	10.00
14	14.00	12.00
16	16.00	14.00
18	18.00	16.00
20	20.00	18.00
22	22.00	20.00
24	24.00	22.00
26	26.00	24.00
28	28.00	26.00
30	30.00	28.00
32	32.00	30.00
34	34.00	32.00
36	36.00	34.00
38	38.00	36.00
40	40.00	38.00
42	42.00	40.00
44	44.00	42.00
46	46.00	44.00
48	48.00	46.00
50	50.00	48.00

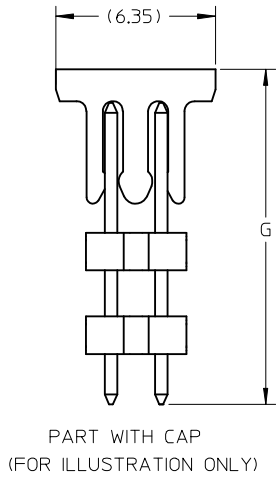

PART NUMBERS	CKT SIZE	VOID POSITION	KINK POSITION	CAP OPTION	DIMENSION				(G)	PLATING OPTION	PACKAGING TYPE
					MATING END (M)	STACKER HEIGHT (H)	SOLDER TAIL (P)	(F)			
87761-0401	4	----	----	----	4.00	15.50	3.50	23.00	-	3	TRAY
87761-0600	6	----	----	----	7.00	5.00	2.80	14.80	-	5	
87761-0801	8	3,4,5,6	----	----	4.00	15.50	3.50	23.00	-	3	
87761-0800	8	----	----	----	8.70	16.00	3.50	28.20	-	4	BULK
87761-0802	8	----	----	----	3.50	21.34	3.50	28.34	-	8	TRAY
87761-1006	10	1	----	----	1.16	3.05	3.99	8.20	-	5	
87761-1009	10	----	----	----	1.16	3.05	3.99	8.20	-	5	
87761-1007	10	----	----	----	2.60	34.00	2.60	39.20	-	5	
87761-1000	10	----	----	----	5.50	27.50	3.43	36.43	-	4	
87761-1001	10	----	----	----	2.50	14.50	4.00	21.00	-	4	
87761-0012	12	----	----	----	2.60	10.00	3.70	16.30	-	5	
87761-1200	12	----	----	----	4.00	24.00	2.79	30.79	-	4	
87761-1400	14	----	----	----	1.90	3.00	4.50	9.40	-	5	
87761-0016	16	----	----	----	4.00	9.15	3.85	17.00	-	3	
87761-1601	16	----	----	YES	4.50	4.00	4.50	13.00	14.27	5	TUBE
87761-0017	16	----	----	----	3.00	3.00	2.70	8.70	-	5	TRAY
87761-1600	16	----	----	----	7.00	5.00	2.80	14.80	-	5	
87761-0020	20	----	----	----	6.00	4.00	2.90	12.90	-	5	
87761-0031	20	----	----	----	3.00	4.00	2.03	9.00	-	6	
87761-2000	20	----	----	----	4.00	24.00	2.79	30.79	-	4	
87761-2001	20	----	----	----	2.50	14.50	4.00	21.00	-	4	
87761-2018	20	----	----	----	4.50	10.16	4.45	19.10	-	3	
87761-2400	24	----	----	----	5.50	27.50	2.80	35.80	-	4	
87761-2401	24	----	----	----	2.00	60.00	2.00	64.00	-	7	
87761-2402	24	----	----	----	2.00	42.00	2.00	46.00	-	7	
87761-2610	26	----	----	----	5.30	6.30	2.70	14.30	-	4	
87761-3000	30	----	----	----	4.00	17.30	4.00	25.30	-	1	
87761-0024	40	----	----	----	8.89	15.88	3.43	28.20	-	4	
87761-4000	40	----	----	----	2.60	3.00	2.60	8.20	-	5	
87761-4001	40	----	----	----	4.65	19.30	4.65	28.60	-	9	
87761-4218	42	----	----	----	4.50	10.16	4.45	19.10	-	3	

NOTES:
 APPLY ONLY FOR PART#87761-5021 & 87761-5022

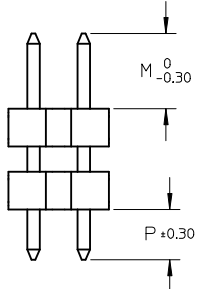

ADD P/N:87761-4001 EC NO: S2012-0955 DRWN:SKANG 2012/06/26 CHKD:ATSEE 2012/07/16 APPR:MLONG 2012/07/17	QUALITY SYMBOLS	GENERAL TOLERANCES (UNLESS SPECIFIED)	DIMENSION STYLE	SCALE	DESIGN UNITS	THIRD ANGLE PROJECTION	
	$F_A = 0$ $F_G = 0$ $F_P = 0$	mm INCH 4 PLACES ± --- ± --- 3 PLACES ± --- ± --- 2 PLACES ± 0.20 ± --- 1 PLACE ± --- ± --- ANGULAR ± 3°	MM ONLY	NTS	METRIC		
		DRAFT WHERE APPLICABLE MUST REMAIN WITHIN DIMENSIONS	DRAWN BY DATE	TITLE	2MM DUAL ROW DUAL WAFER HEADER, VERTICAL T/H		
			CHECKED BY DATE	APPROVED BY DATE	MOLEX INCORPORATED		
			MATERIAL NO.	DOCUMENT NO.	SD-87761-052		
			SIZE	THIS DRAWING CONTAINS INFORMATION THAT IS PROPRIETARY TO MOLEX INCORPORATED AND SHOULD NOT BE USED WITHOUT WRITTEN PERMISSION			

PART NUMBERS	CKT SIZE	VOID POSITION	KINK POSITION	DIMENSION				PLATING OPTION	PACKAGING TYPE
				MATING END	STACKER HEIGHT	SOLDER TAIL	(F)		
				M	H	(P)			
87761-4400	44	----	----	7.00	5.00	4.00	16.00	5	TRAY
87761-0026	50	----	----	8.89	15.88	3.43	28.20	4	
87761-5000	50	----	----	3.50	10.00	3.50	17.00	5	
87761-5001	50	----	----	2.50	10.30	4.00	16.80	4	
87761-5002	50	----	----	2.50	11.70	2.60	16.80	4	
△ 87761-5021	50	----	----	4.00	8.70	2.50	15.20	3	
△ 87761-5022	50	----	----	4.00	5.71	2.50	12.21	3	

ADD P/N: 87761-4001 EC NO: S2012-0955 DRWN: SKANG 2012/06/26 CHKD: ATSEE 2012/07/16 APPR: MLONG 2012/07/17	DESCRIPTION REV	QUALITY SYMBOLS	GENERAL TOLERANCES (UNLESS SPECIFIED)	DIMENSION STYLE	SCALE	DESIGN UNITS	THIRD ANGLE PROJECTION															
		$\nabla_A = 0$ $\nabla_C = 0$ $\nabla_P = 0$	<table border="1"> <tr> <th></th> <th>mm</th> <th>INCH</th> </tr> <tr> <td>4 PLACES</td> <td>± ---</td> <td>± ---</td> </tr> <tr> <td>3 PLACES</td> <td>± ---</td> <td>± ---</td> </tr> <tr> <td>2 PLACES</td> <td>± 0.20</td> <td>± ---</td> </tr> <tr> <td>1 PLACE</td> <td>± ---</td> <td>± ---</td> </tr> </table>		mm	INCH	4 PLACES	± ---	± ---	3 PLACES	± ---	± ---	2 PLACES	± 0.20	± ---	1 PLACE	± ---	± ---	MM ONLY	NTS	METRIC	
			mm	INCH																		
		4 PLACES	± ---	± ---																		
3 PLACES	± ---	± ---																				
2 PLACES	± 0.20	± ---																				
1 PLACE	± ---	± ---																				
	<table border="1"> <tr> <th>DRAWN BY</th> <th>DATE</th> <th>TITLE</th> </tr> <tr> <td>KCHO</td> <td>2005/02/23</td> <td rowspan="3">2MM DUAL ROW DUAL WAFER HEADER, VERTICAL T/H</td> </tr> <tr> <th>CHECKED BY</th> <th>DATE</th> </tr> <tr> <td>PTLIM</td> <td>2005/04/26</td> </tr> </table>	DRAWN BY	DATE	TITLE	KCHO	2005/02/23	2MM DUAL ROW DUAL WAFER HEADER, VERTICAL T/H	CHECKED BY	DATE	PTLIM	2005/04/26											
DRAWN BY	DATE	TITLE																				
KCHO	2005/02/23	2MM DUAL ROW DUAL WAFER HEADER, VERTICAL T/H																				
CHECKED BY	DATE																					
PTLIM	2005/04/26																					
	<table border="1"> <tr> <th>APPROVED BY</th> <th>DATE</th> <th>MATERIAL NO.</th> <th>DOCUMENT NO.</th> <th>SHEET NO.</th> </tr> <tr> <td>MLONG</td> <td>2010/11/11</td> <td>SEE TABLE</td> <td>SD-87761-052</td> <td>3 OF 3</td> </tr> </table>	APPROVED BY	DATE	MATERIAL NO.	DOCUMENT NO.	SHEET NO.	MLONG	2010/11/11	SEE TABLE	SD-87761-052	3 OF 3											
APPROVED BY	DATE	MATERIAL NO.	DOCUMENT NO.	SHEET NO.																		
MLONG	2010/11/11	SEE TABLE	SD-87761-052	3 OF 3																		

THIS DRAWING CONTAINS INFORMATION THAT IS PROPRIETARY TO MOLEX INCORPORATED AND SHOULD NOT BE USED WITHOUT WRITTEN PERMISSION