



Chipsmall Limited consists of a professional team with an average of over 10 year of expertise in the distribution of electronic components. Based in Hongkong, we have already established firm and mutual-benefit business relationships with customers from,Europe,America and south Asia,supplying obsolete and hard-to-find components to meet their specific needs.

With the principle of “Quality Parts,Customers Priority,Honest Operation,and Considerate Service”,our business mainly focus on the distribution of electronic components. Line cards we deal with include Microchip,ALPS,ROHM,Xilinx,Pulse,ON,Everlight and Freescale. Main products comprise IC,Modules,Potentiometer,IC Socket,Relay,Connector.Our parts cover such applications as commercial,industrial, and automotives areas.

We are looking forward to setting up business relationship with you and hope to provide you with the best service and solution. Let us make a better world for our industry!



## Contact us

Tel: +86-755-8981 8866 Fax: +86-755-8427 6832

Email & Skype: info@chipsmall.com Web: www.chipsmall.com

Address: A1208, Overseas Decoration Building, #122 Zhenhua RD., Futian, Shenzhen, China



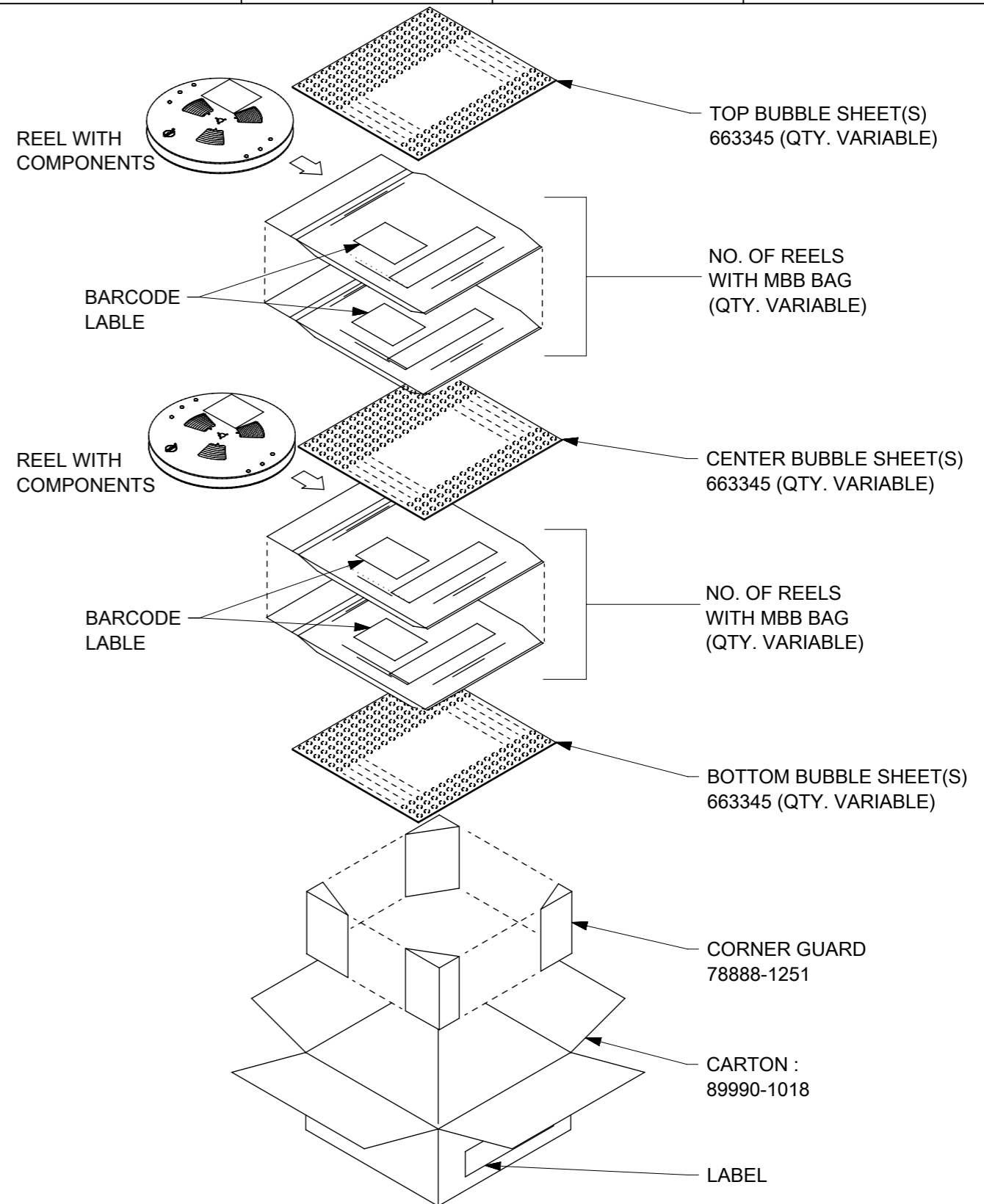
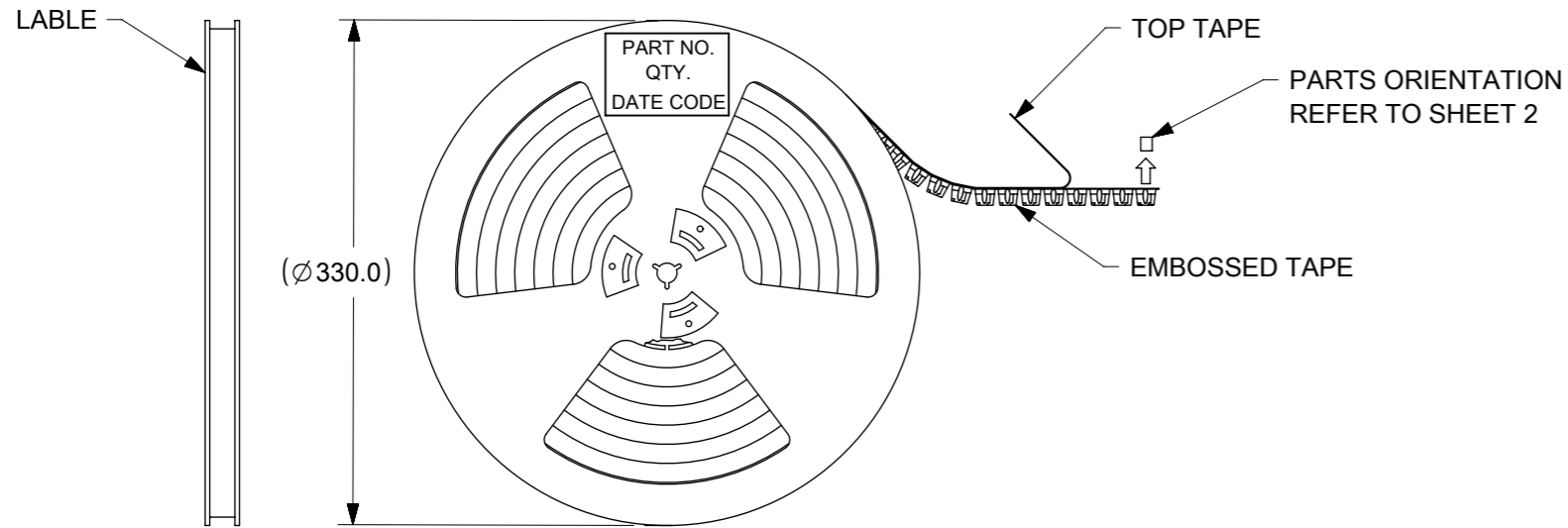

- NOTES:
1. ALL REQUIREMENTS FOR TAPING SURFACE MOUNT COMPONENTS IS AS PER EIA-481 STANDARD.
  3. THE TOP COVER TAPE SHALL BE CLEAR ONLY, AND SHALL NOT EXTEND OVER THE EDGES OF THE CARRIER TAPE OR COVER ANY PART OF THE SPROCKET HOLES.
  4. THE TOP COVER TAPE MUST BE SECURELY ATTACHED TO THE EMBOSSED CARRIER TAPE BY USE OF HEAT.
  5. EACH REEL SHALL HAVE A LABEL AFFIXED TO IT WITH THE FOLLOWING INFORMATION:  
PART NO., QUANTITY, DATE CODE
  6. EACH REEL MUST BE PACKED IN AN MBB BAG.
  7. TAPE SPLICES ARE NOT PERMITTED.

THIS DRAWING CONTAINS INFORMATION THAT IS PROPRIETARY TO MOLEX ELECTRONIC TECHNOLOGIES, LLC AND SHOULD NOT BE USED WITHOUT WRITTEN PERMISSION												
QUALITY SYMBOLS ▽A = 0 ▽E = 0 ▽B = 0 ▼ = 0 ▽C = 0 ⊠ = 0 ■ = 0 ▽ = 0	RE-MASTERED IN ELECTR EC NO: 119993 DRWN: MUM CHK'D: GMENARLY REV APPR: KHLIM	GENERAL TOLERANCES (UNLESS SPECIFIED)		DIMENSION UNITS		SCALE						
				MM	INCH	MM	NTS					
				4 PLACES ±	±	DRWN BY	DATE		PACKAGING SPECIFICATION FOR 87832 IN T&R			
				3 PLACES ±	±	ATSEE	2015/08/24					
				2 PLACES ±	±	CHK'D BY	DATE		PACKAGING DESIGN DRAWING			
				1 PLACES ±	±	CGOH	2015/08/24					
				0 PLACES ±	±	APPR BY	DATE		SERIES: 87832 MATERIAL NUMBER: SEE TABLE CUSTOMER: GENERAL MARKET			
				ANGULAR TOL = 1.0		KHLIM	2017/05/26					
				DRAFT WHERE APPLICABLE MUST REMAIN WITHIN DIMENSIONS		DRAWING SIZE	THIRD ANGLE PROJECTION		DOCUMENT NUMBER: PK-87832-300 DOC TYPE: PDD DOC PART: 001 SHEET NUMBER: 1 OF 12			
						A3						

# TAPE AND REEL PACKAGING SPECIFICATIONS

## EMBOSSED TAPE WIDTH FROM 16.00mm TO 24.00mm

8 CKT USE FOR ILLUSTRATION ONLY.

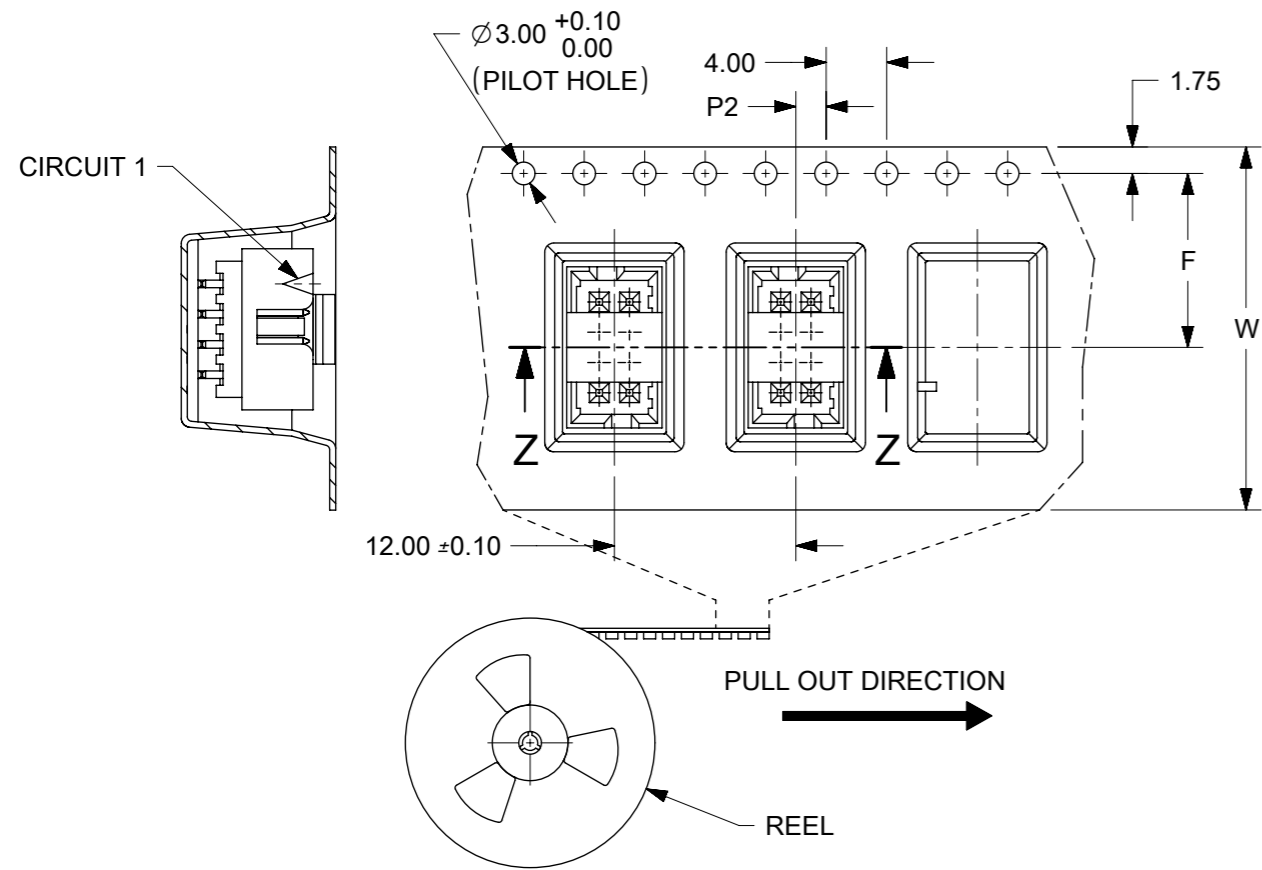

## EMBOSSED TAPE WIDTH FROM 44.00mm TO 72.00mm

24 CKT USE FOR ILLUSTRATION ONLY.

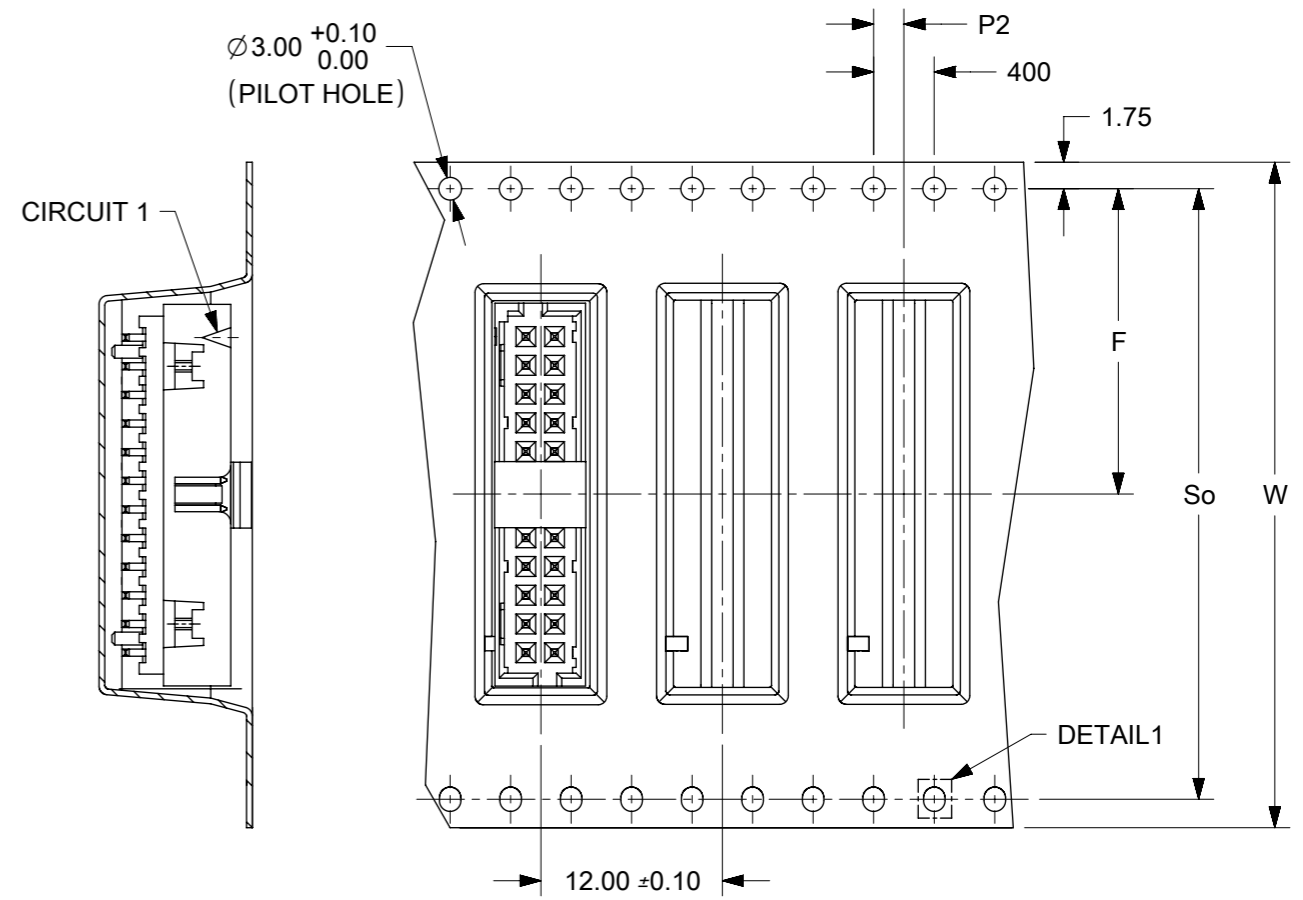

### NOTES:

1. LEADER AND TRAILER TAPE

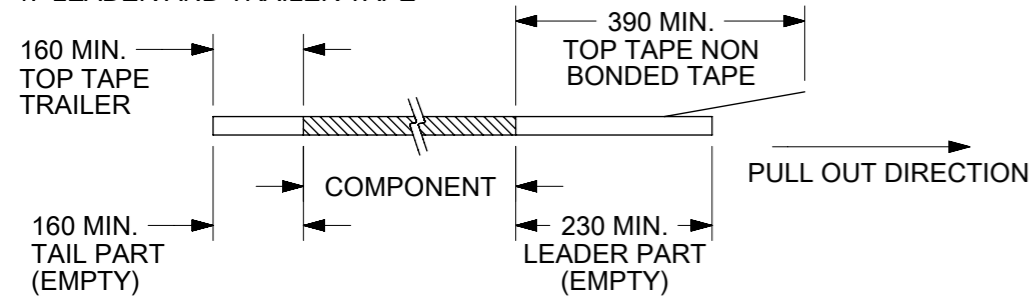

2. PEELING OFF FORCE OF THE TOP TAPE: 10 - 130gf.  
(PEELING DIRECTION AS SHOWN IN FOLLOWING FIGURE)

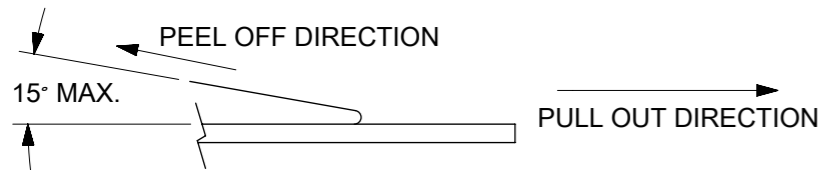

- 3. TAPE AND REEL SPECIFICATION IS AS PER EIA-481.
- 4. TAPE AND REEL QUANTITY : SEE TABLE
- 5. THE TAPE IS TREATED FOR ANTI-STATIC.

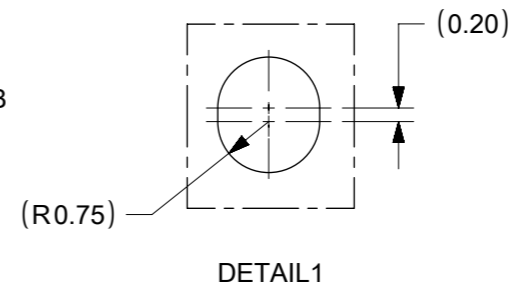
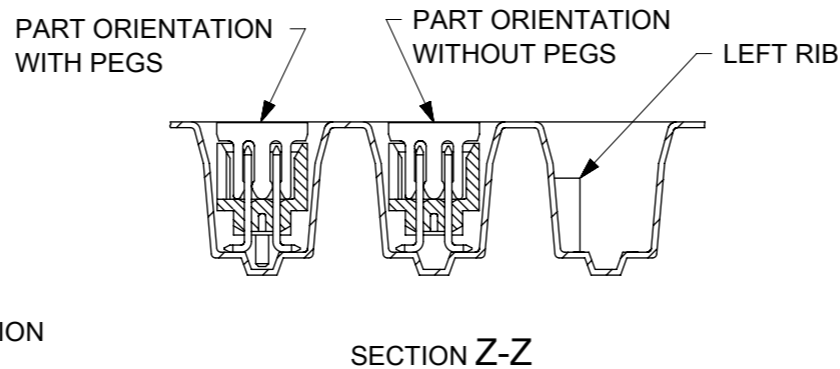

W	F	So	P2
16	7.50±0.10	-	2.00±0.10
24	11.50±0.10	-	2.00±0.10
32	14.20±0.10	28.40±0.10	2.00±0.10
44	20.20±0.15	40.40±0.10	2.00±0.15
56	26.20±0.15	52.40±0.10	2.00±0.15
72	34.20±0.30	68.40±0.10	2.00±0.20

THIS DRAWING CONTAINS INFORMATION THAT IS PROPRIETARY TO MOLEX ELECTRONIC TECHNOLOGIES, LLC AND SHOULD NOT BE USED WITHOUT WRITTEN PERMISSION											
QUALITY SYMBOLS	RE-MASTERED IN ELECTR	EC NO: 119993	DRWN: MUM	CHKD: GMENARLY	REV APPR: KHLIM	GENERAL TOLERANCES (UNLESS SPECIFIED)		DIMENSION UNITS	SCALE		
						MM	INCH	MM	NTS		
▽A = 0						4 PLACES ± ±	DRWN BY	DATE	PACKAGING SPECIFICATION FOR 87832 IN T&R		
▽E = 0						3 PLACES ± ±	ATSEE	2015/08/24			
▽B = 0						2 PLACES ± ±	CHK'D BY	DATE	PACKAGING DESIGN DRAWING		
▼ = 0						1 PLACES ± ±	CGOH	2015/08/24			
▽C = 0						0 PLACES ± ±	APPR BY	DATE	SERIES: 87832    MATERIAL NUMBER: SEE TABLE    CUSTOMER: GENERAL MARKET		
⊠ = 0						ANGULAR TOL = 1.0	KHLIM	2017/05/26			
■ = 0						DRAFT WHERE APPLICABLE MUST REMAIN WITHIN DIMENSIONS	DRAWING SIZE	THIRD ANGLE PROJECTION	DOCUMENT NUMBER: PK-87832-300    DOC TYPE: PDD    DOC PART: 001    SHEET NUMBER: 2 OF 12		
▽ = 0							A3				













CKTS	PART NUMBER	EMBOSSSED TAPE	REEL	TOP TAPE	OPTION (SEE SHEET 12)	EMBOSS WIDTH	QTY./REEL	REELS/CARTON	BUBBLE SHEETS QTY.			CORNER GUIDES 78888-1251
									TOP	CENTER	BOTTOM	
4	87832-0406	89990-0145	89990-5709	89990-5602	1	16	500	7	-	-	-	-
	87832-0407	89990-0145	89990-5709	89990-5602	1	16	500	7	-	-	-	-
	87832-5122	89990-7601	89990-5709	89990-5602	1	16	500	7	-	-	-	-
	87832-5123	89990-7601	89990-5709	89990-5602	1	16	500	7	-	-	-	-
	87832-5162	89990-7601	89990-5709	89990-5602	1	16	500	7	-	-	-	-
	87832-5172	89990-7601	89990-5709	89990-5602	1	16	500	7	-	-	-	-
	87832-5106	151000-4241	89990-5710	89990-5603	2	24	500	5	-	-	-	-
6	87832-0606	89990-7752	89990-5710	89990-5603	1	24	500	5	-	-	-	-
	87832-0607	89990-7752	89990-5710	89990-5603	1	24	500	5	-	-	-	-
	87832-0614	89990-7602	89990-5710	89990-5603	1	24	500	5	-	-	-	-
	87832-0615	89990-7602	89990-5710	89990-5603	1	24	500	5	-	-	-	-
	87832-0628	89990-7752	89990-5710	89990-5603	1	24	500	5	-	-	-	-
	87832-0629	89990-7752	89990-5710	89990-5603	1	24	500	5	-	-	-	-
	87832-0642	89990-7752	89990-5710	89990-5603	1	24	500	4	-	-	-	-
	87832-5222	89990-7602	89990-5710	89990-5603	1	24	500	5	-	-	-	-
	87832-5223	89990-7602	89990-5710	89990-5603	1	24	500	5	-	-	-	-
	87832-5262	89990-7602	89990-5710	89990-5603	1	24	500	5	-	-	-	-
	87832-5272	89990-7602	89990-5710	89990-5603	1	24	500	5	-	-	-	-

<b>QUALITY SYMBOLS</b> 	THIS DRAWING CONTAINS INFORMATION THAT IS PROPRIETARY TO MOLEX ELECTRONIC TECHNOLOGIES, LLC AND SHOULD NOT BE USED WITHOUT WRITTEN PERMISSION																			
	RE-MASTERED IN ELECTRICAL			2017/06/27		2017/08/10		2017/08/10		GENERAL TOLERANCES (UNLESS SPECIFIED)		DIMENSION UNITS		SCALE		 <b>PACKAGING SPECIFICATION FOR 87832 IN T&amp;R</b> <b>PACKAGING DESIGN DRAWING</b> SERIES: 87832    MATERIAL NUMBER: SEE TABLE    CUSTOMER: GENERAL MARKET				
	EC NO: 119993		DRWN: MUM		CHK'D: GMENARLY		REV APPR: KHLIM		MM		INCH		MM		NTS					
	4 PLACES		±		±		±		DRWN BY		DATE		ATSEE		2015/08/24					
	3 PLACES		±		±		±		CHK'D BY		DATE		CGOH		2015/08/24					
	2 PLACES		±		±		±		APPR BY		DATE		KHLIM		2017/05/26					
	1 PLACES		±		±		±		DRAWING SIZE		THIRD ANGLE PROJECTION		A3							
	0 PLACES		±		±		±		ANGULAR TOL = 1.0		DRAFT WHERE APPLICABLE MUST REMAIN WITHIN DIMENSIONS									
	DOCUMENT NUMBER		PK-87832-300		DOC TYPE		PDD		DOC PART		001		SHEET NUMBER		3 OF 12					

CKTS	PART NUMBER	EMBOSSSED TAPE	REEL	TOP TAPE	OPTION (SEE SHEET 12)	EMBOSS WIDTH	QTY./REEL	REELS/CARTON	BUBBLE SHEETS QTY.			CORNER GUIDES 78888-1251
									TOP	CENTER	BOTTOM	
8	87832-0806	89990-7753	89990-5710	89990-5603	1	24	500	5	-	-	-	-
	87832-0807	89990-7753	89990-5710	89990-5603	1	24	500	5	-	-	-	-
	87832-0814	89990-7603	89990-5710	89990-5603	1	24	500	5	-	-	-	-
	87832-0828	89990-7753	89990-5710	89990-5603	1	24	500	5	-	-	-	-
	87832-0829	89990-7753	89990-5710	89990-5603	1	24	500	5	-	-	-	-
	87832-0836	89990-7753	89990-5710	89990-5603	1	24	500	5	-	-	-	-
	87832-0842	89990-7753	89990-5710	89990-5603	1	24	500	5	-	-	-	-
	87832-5322	89990-7603	89990-5710	89990-5603	1	24	500	5	-	-	-	-
	87832-5323	89990-7603	89990-5710	89990-5603	1	24	500	5	-	-	-	-
	87832-5352	89990-7603	89990-5710	89990-5603	1	24	500	5	-	-	-	-
	87832-5362	89990-7603	89990-5710	89990-5603	1	24	500	5	-	-	-	-
	87832-5372	89990-7603	89990-5710	89990-5603	1	24	500	5	-	-	-	-

THIS DRAWING CONTAINS INFORMATION THAT IS PROPRIETARY TO MOLEX ELECTRONIC TECHNOLOGIES, LLC AND SHOULD NOT BE USED WITHOUT WRITTEN PERMISSION											
QUALITY SYMBOLS		RE-MASTERED IN ECTR		GENERAL TOLERANCES (UNLESS SPECIFIED)		DIMENSION UNITS		SCALE		 PACKAGING SPECIFICATION FOR 87832 IN T&R	
▽A = 0	▽B = 0	2017/06/27	2017/08/10	MM	INCH	MM	NTS	DRWN BY: ATSEE      DATE: 2015/08/24 CHK'D BY: CGOH      DATE: 2015/08/24 APPR BY: KHLIM      DATE: 2017/05/26			
▽C = 0	▽D = 0	EC NO: 119993	DRWN: MUM	4 PLACES ±	3 PLACES ±	3 PLACES ±	2 PLACES ±	2 PLACES ±	1 PLACES ±	0 PLACES ±	SERIES: 87832      MATERIAL NUMBER: SEE TABLE      CUSTOMER: GENERAL MARKET DOCUMENT NUMBER: PK-87832-300      DOC TYPE: PDD      DOC PART: 001      SHEET NUMBER: 4 OF 12
▽E = 0	▽F = 0	CHKD: GMENARLY	APP: KHLIM	2 PLACES ±	1 PLACES ±	1 PLACES ±	0 PLACES ±	ANGULAR TOL = 1.0	DRAWING SIZE: A3      THIRD ANGLE PROJECTION		
▽G = 0	▽H = 0	DRAFT WHERE APPLICABLE MUST REMAIN WITHIN DIMENSIONS									

CKTS	PART NUMBER	EMBOSSSED TAPE	REEL	TOP TAPE	OPTION (SEE SHEET 12)	EMBOSS WIDTH	QTY./REEL	REELS/CARTON	BUBBLE SHEETS QTY.			CORNER GUIDES 78888-1251
									TOP	CENTER	BOTTOM	
10	87832-1006	89990-7754	89990-5710	89990-5603	1	24	500	5	-	-	-	-
	87832-1007	89990-7754	89990-5710	89990-5603	1	24	500	5	-	-	-	-
	87832-1014	89990-7604	89990-5710	89990-5603	1	24	500	5	-	-	-	-
	87832-1028	89990-7754	89990-5710	89990-5603	1	24	500	5	-	-	-	-
	87832-1029	89990-7754	89990-5710	89990-5603	1	24	500	5	-	-	-	-
	87832-1040	89990-7754	89990-5710	89990-5603	1	24	500	5	-	-	-	-
	87832-1042	89990-7754	89990-5710	89990-5603	1	24	500	5	-	-	-	-
	87832-5422	89990-7604	89990-5710	89990-5603	1	24	500	5	-	-	-	-
	87832-5423	89990-7604	89990-5710	89990-5603	1	24	500	5	-	-	-	-
	87832-5462	89990-7604	89990-5710	89990-5603	1	24	500	5	-	-	-	-
	87832-5472	89990-7604	89990-5710	89990-5603	1	24	500	5	-	-	-	-
	87832-9423	89990-7704	89990-5710	89990-5603	2	24	400	5	-	-	-	-

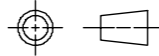
THIS DRAWING CONTAINS INFORMATION THAT IS PROPRIETARY TO MOLEX ELECTRONIC TECHNOLOGIES, LLC AND SHOULD NOT BE USED WITHOUT WRITTEN PERMISSION														
QUALITY SYMBOLS		RE-MASTERED IN ECTR		GENERAL TOLERANCES (UNLESS SPECIFIED)		DIMENSION UNITS		SCALE		 PACKAGING SPECIFICATION FOR 87832 IN T&R				
 = 0	 = 0	2017/06/27	2017/08/10	MM	INCH	MM	NTS	DRWN BY DATE						
 = 0	 = 0	2017/08/10	2017/08/10	4 PLACES ± ±		ATSEE		2015/08/24		PACKAGING DESIGN DRAWING				
 = 0	 = 0	EC NO: 119993	DRWN: MUM	3 PLACES ± ±		CHK'D BY DATE		2015/08/24						
 = 0	 = 0	CHK'D: GMENARLY	APP: KHLIM	2 PLACES ± ±		APPR BY DATE		2017/05/26		SERIES MATERIAL NUMBER CUSTOMER				
 = 0	 = 0	REV		1 PLACES ± ±		KHLIM				87832	SEE TABLE	GENERAL MARKET		
 = 0	= 0	A		0 PLACES ± ±		DRAWING SIZE	THIRD ANGLE PROJECTION			DOCUMENT NUMBER		DOC TYPE	DOC PART	SHEET NUMBER
				ANGULAR TOL = 1.0		A3				PK-87832-300		PDD	001	5 OF 12
				DRAFT WHERE APPLICABLE MUST REMAIN WITHIN DIMENSIONS										

CKTS	PART NUMBER	EMBOSSSED TAPE	REEL	TOP TAPE	OPTION (SEE SHEET 12)	EMBOSS WIDTH	QTY./REEL	REELS/CARTON	BUBBLE SHEETS QTY.			CORNER GUIDES 78888-1251
									TOP	CENTER	BOTTOM	
12	87832-1206	89990-7755	89990-5711	89990-5604	1	32	500	4	-	-	-	-
	87832-1207	89990-7755	89990-5711	89990-5604	1	32	500	4	-	-	-	-
	87832-1242	89990-7755	89990-5711	89990-5604	1	32	500	4	-	-	-	-
	87832-1228	89990-7755	89990-5711	89990-5604	1	32	500	4	-	-	-	-
	87832-1229	89990-7755	89990-5711	89990-5604	1	32	500	4	-	-	-	-
	87832-5522	89990-7605	89990-5711	89990-5604	1	32	500	4	-	-	-	-
	87832-5523	89990-7605	89990-5711	89990-5604	1	32	500	4	-	-	-	-
	87832-5562	89990-7605	89990-5711	89990-5604	1	32	500	4	-	-	-	-
	87832-5572	89990-7605	89990-5711	89990-5604	1	32	500	4	-	-	-	-
14	87832-1414	89990-7756	89990-5711	89990-5604	1	32	500	4	-	-	-	-
	87832-5622	89990-7756	89990-5711	89990-5604	1	32	500	4	-	-	-	-
	87832-5623	89990-7756	89990-5711	89990-5604	1	32	500	4	-	-	-	-
	87832-5662	89990-7756	89990-5711	89990-5604	1	32	500	4	-	-	-	-
	87832-5672	89990-7756	89990-5711	89990-5604	1	32	500	4	-	-	-	-
	87832-9523	89990-7706	89990-5711	89990-5604	2	32	500	4	-	-	-	-

<b>QUALITY SYMBOLS</b> 	THIS DRAWING CONTAINS INFORMATION THAT IS PROPRIETARY TO MOLEX ELECTRONIC TECHNOLOGIES, LLC AND SHOULD NOT BE USED WITHOUT WRITTEN PERMISSION														
	<b>RE-MASTERED IN ELECTR</b> EC NO: 119993 DRWN: MUM CHK'D: GMENARLY REV APPR: KHLIM	2017/06/27		2017/08/10		2017/08/10		GENERAL TOLERANCES (UNLESS SPECIFIED)		DIMENSION UNITS		SCALE			
		MM		INCH		MM		NTS		DRWN BY		DATE			
		4 PLACES ±		±		ATSEE		2015/08/24							
		3 PLACES ±		±		CHK'D BY		DATE		PACKAGING SPECIFICATION FOR 87832 IN T&R					
		2 PLACES ±		±		CGOH		2015/08/24							
		1 PLACES ±		±		APPR BY		DATE							
		0 PLACES ±		±		KHLIM		2017/05/26		PACKAGING DESIGN DRAWING					
		ANGULAR TOL = 1.0		DRAFT WHERE APPLICABLE MUST REMAIN WITHIN DIMENSIONS		DRAWING SIZE		THIRD ANGLE PROJECTION						SERIES	
		A		A3		A3				87832		SEE TABLE		GENERAL MARKET	
								DOCUMENT NUMBER		DOC TYPE		DOC PART		SHEET NUMBER	
								PK-87832-300		PDD		001		6 OF 12	

CKTS	PART NUMBER	EMBOSSSED TAPE	REEL	TOP TAPE	OPTION (SEE SHEET 12)	EMBOSS WIDTH	QTY./REEL	REELS/CARTON	BUBBLE SHEETS QTY.			CORNER GUIDES 78888-1251
									TOP	CENTER	BOTTOM	
16	87832-1614	89990-7757	89990-5711	89990-5604	1	32	500	4	-	-	-	-
	87832-5722	89990-7757	89990-5711	89990-5604	1	32	500	4	-	-	-	-
	87832-5723	89990-7757	89990-5711	89990-5604	1	32	500	4	-	-	-	-
	87832-5762	89990-7757	89990-5711	89990-5604	1	32	500	4	-	-	-	-
	87832-5772	89990-7757	89990-5711	89990-5604	1	32	500	4	-	-	-	-
18	87832-1814	89990-7658	89990-5712	89990-5605	3	44	500	3	-	-	-	-
	87832-1815	89990-7658	89990-5712	89990-5605	3	44	500	3	-	-	-	-
	87832-5822	89990-7758	89990-5712	89990-5605	1	44	500	3	-	-	-	-
	87832-5823	89990-7758	89990-5712	89990-5605	1	44	500	3	-	-	-	-
	87832-5862	89990-7758	89990-5712	89990-5605	1	44	500	3	-	-	-	-
	87832-5872	89990-7758	89990-5712	89990-5605	1	44	500	3	-	-	-	-
20	87832-2014	89990-7759	89990-5712	89990-5605	1	44	500	3	-	-	-	-
	87832-5922	89990-7759	89990-5712	89990-5605	1	44	500	3	-	-	-	-
	87832-5923	89990-7759	89990-5712	89990-5605	1	44	500	3	-	-	-	-
	87832-5962	89990-7759	89990-5712	89990-5605	1	44	500	3	-	-	-	-
	87832-5972	89990-7759	89990-5712	89990-5605	1	44	500	3	-	-	-	-

THIS DRAWING CONTAINS INFORMATION THAT IS PROPRIETARY TO MOLEX ELECTRONIC TECHNOLOGIES, LLC AND SHOULD NOT BE USED WITHOUT WRITTEN PERMISSION																														
<b>QUALITY SYMBOLS</b> 	<b>RE-MASTERED IN ELECTR</b> EC NO: 119993 DRWN: MUM CHK'D: GMENARLY REV APPR: KHLIM		2017/06/27 2017/08/10 2017/08/10		<b>GENERAL TOLERANCES (UNLESS SPECIFIED)</b> <table border="1"> <tr> <td></td> <td>MM</td> <td>INCH</td> </tr> <tr> <td>4 PLACES</td> <td>±</td> <td>±</td> </tr> <tr> <td>3 PLACES</td> <td>±</td> <td>±</td> </tr> <tr> <td>2 PLACES</td> <td>±</td> <td>±</td> </tr> <tr> <td>1 PLACES</td> <td>±</td> <td>±</td> </tr> <tr> <td>0 PLACES</td> <td>±</td> <td>±</td> </tr> </table>			MM	INCH	4 PLACES	±	±	3 PLACES	±	±	2 PLACES	±	±	1 PLACES	±	±	0 PLACES	±	±	<b>DIMENSION UNITS</b> MM		<b>SCALE</b> NTS			
		MM	INCH																											
	4 PLACES	±	±																											
	3 PLACES	±	±																											
	2 PLACES	±	±																											
	1 PLACES	±	±																											
	0 PLACES	±	±																											
	<b>DRWN BY</b> ATSEE		<b>DATE</b> 2015/08/24		<b>PACKAGING SPECIFICATION FOR 87832 IN T&amp;R</b>																									
	<b>CHK'D BY</b> CGOH		<b>DATE</b> 2015/08/24																											
	<b>APPR BY</b> KHLIM		<b>DATE</b> 2017/05/26		<b>PACKAGING DESIGN DRAWING</b>																									
<b>ANGULAR TOL = 1.0</b>		<b>DRAFT WHERE APPLICABLE MUST REMAIN WITHIN DIMENSIONS</b>		<b>DRAWING SIZE</b> A3		<b>THIRD ANGLE PROJECTION</b>		<table border="1"> <tr> <td>SERIES</td> <td>MATERIAL NUMBER</td> <td>CUSTOMER</td> </tr> <tr> <td>87832</td> <td>SEE TABLE</td> <td>GENERAL MARKET</td> </tr> </table>		SERIES	MATERIAL NUMBER	CUSTOMER	87832	SEE TABLE	GENERAL MARKET															
SERIES	MATERIAL NUMBER	CUSTOMER																												
87832	SEE TABLE	GENERAL MARKET																												
<b>DOCUMENT NUMBER</b> PK-87832-300		<b>DOC TYPE</b> PDD		<b>DOC PART</b> 001		<b>SHEET NUMBER</b> 7 OF 12																								



CKTS	PART NUMBER	EMBOSSSED TAPE	REEL	TOP TAPE	OPTION (SEE SHEET 12)	EMBOSS WIDTH	QTY./REEL	REELS/CARTON	BUBBLE SHEETS QTY.			CORNER GUIDES 78888-1251
									TOP	CENTER	BOTTOM	
22	87832-6022	89990-7760	89990-5712	89990-5605	1	44	500	3	-	-	-	-
	87832-6023	89990-7760	89990-5712	89990-5605	1	44	500	3	-	-	-	-
	87832-6052	89990-7760	89990-5712	89990-5605	1	44	500	3	-	-	-	-
	87832-6062	89990-7760	89990-5712	89990-5605	1	44	500	3	-	-	-	-
	87832-6072	89990-7760	89990-5712	89990-5605	1	44	500	3	-	-	-	-
24	87832-2414	89990-7761	89990-5712	89990-5605	1	44	500	3	-	-	-	-
	87832-6122	89990-7761	89990-5712	89990-5605	1	44	500	3	-	-	-	-
	87832-6123	89990-7761	89990-5712	89990-5605	1	44	500	3	-	-	-	-
	87832-6162	89990-7761	89990-5712	89990-5605	1	44	500	3	-	-	-	-
	87832-6172	89990-7761	89990-5712	89990-5605	1	44	500	3	-	-	-	-
26	87832-6222	89990-7762	89990-5712	89990-5605	1	44	500	3	-	-	-	-
	87832-6223	89990-7762	89990-5712	89990-5605	1	44	500	3	-	-	-	-
	87832-6262	89990-7762	89990-5712	89990-5605	1	44	500	3	-	-	-	-
	87832-6272	89990-7762	89990-5712	89990-5605	1	44	500	3	-	-	-	-

THIS DRAWING CONTAINS INFORMATION THAT IS PROPRIETARY TO MOLEX ELECTRONIC TECHNOLOGIES, LLC AND SHOULD NOT BE USED WITHOUT WRITTEN PERMISSION													
<b>QUALITY SYMBOLS</b> 	RE-MASTERED IN ELECTRICAL			EC NO: 119993 DRWN: MUM CHK'D: GMENARLY REV APPR: KHLIM		2017/06/27 2017/08/10 2017/08/10		GENERAL TOLERANCES (UNLESS SPECIFIED) MM INCH 4 PLACES ± ± 3 PLACES ± ± 2 PLACES ± ± 1 PLACES ± ± 0 PLACES ± ±		DIMENSION UNITS MM NTS DRWN BY ATSEE DATE 2015/08/24 CHK'D BY CGOH DATE 2015/08/24 APPR BY KHLIM DATE 2017/05/26		 PACKAGING SPECIFICATION FOR 87832 IN T&R	
	ANGULAR TOL = 1.0 DRAFT WHERE APPLICABLE MUST REMAIN WITHIN DIMENSIONS		DRAWING SIZE A3 THIRD ANGLE PROJECTION		SERIES 87832 MATERIAL NUMBER SEE TABLE CUSTOMER GENERAL MARKET								
	DOCUMENT NUMBER PK-87832-300		DOC TYPE PDD		DOC PART 001		SHEET NUMBER 8 OF 12						

CKTS	PART NUMBER	EMBOSSSED TAPE	REEL	TOP TAPE	OPTION (SEE SHEET 12)	EMBOSS WIDTH	QTY./REEL	REELS/CARTON	BUBBLE SHEETS QTY.			CORNER GUIDES 78888-1251
									TOP	CENTER	BOTTOM	
28	87832-6322	89990-7763	89990-5713	89990-5606	1	56	500	2	-	-	-	-
	87832-6323	89990-7763	89990-5713	89990-5606	1	56	500	2	-	-	-	-
	87832-6362	89990-7763	89990-5713	89990-5606	1	56	500	2	-	-	-	-
	87832-6372	89990-7763	89990-5713	89990-5606	1	56	500	2	-	-	-	-
30	87832-3014	89990-7664	89990-5712	89990-5605	3	56	500	2	-	-	-	-
	87832-6422	89990-7764	89990-5713	89990-5605	1	56	500	2	-	-	-	-
	87832-6423	89990-7764	89990-5713	89990-5605	1	56	500	2	-	-	-	-
	87832-6462	89990-7764	89990-5713	89990-5605	1	56	500	2	-	-	-	-
	87832-6472	89990-7764	89990-5713	89990-5605	1	56	500	2	-	-	-	-
32	87832-6522	89990-7765	89990-5713	89990-5606	1	56	500	2	-	-	-	-
	87832-6523	89990-7765	89990-5713	89990-5606	1	56	500	2	2	2	2	Y
	87832-6562	89990-7765	89990-5713	89990-5606	1	56	500	2	-	-	-	-
	87832-6572	89990-7765	89990-5713	89990-5606	1	56	500	2	-	-	-	-

THIS DRAWING CONTAINS INFORMATION THAT IS PROPRIETARY TO MOLEX ELECTRONIC TECHNOLOGIES, LLC AND SHOULD NOT BE USED WITHOUT WRITTEN PERMISSION											
<b>QUALITY SYMBOLS</b> 	<b>RE-MASTERED IN ELECTR</b> EC NO: 119993 DRWN: MUM CHK'D: GMENARLY REV APPR: KHLIM	GENERAL TOLERANCES (UNLESS SPECIFIED)		DIMENSION UNITS		SCALE		 <b>PACKAGING SPECIFICATION FOR 87832 IN T&amp;R</b>			
		MM	INCH	MM	NTS						
		4 PLACES ±	±	DRWN BY	DATE	<b>PACKAGING DESIGN DRAWING</b>					
		3 PLACES ±	±	ATSEE	2015/08/24						
		2 PLACES ±	±	CHK'D BY	DATE						
		1 PLACES ±	±	CGOH	2015/08/24	SERIES: 87832    MATERIAL NUMBER: SEE TABLE    CUSTOMER: GENERAL MARKET					
		0 PLACES ±	±	APPR BY	DATE						
		ANGULAR TOL = 1.0		KHLIM	2017/05/26	DOCUMENT NUMBER: PK-87832-300    DOC TYPE: PDD    DOC PART: 001    SHEET NUMBER: 9 OF 12					
		DRAFT WHERE APPLICABLE MUST REMAIN WITHIN DIMENSIONS		DRAWING SIZE: A3	THIRD ANGLE PROJECTION						

CKTS	PART NUMBER	EMBOSSSED TAPE	REEL	TOP TAPE	OPTION (SEE SHEET 12)	EMBOSS WIDTH	QTY./REEL	REELS/CARTON	BUBBLE SHEETS QTY.			CORNER GUIDES 78888-1251
									TOP	CENTER	BOTTOM	
34	87832-3414	89990-7666	89990-5713	89990-5606	3	56	500	2	-	-	-	-
	87832-6622	89990-7766	89990-5713	89990-5606	1	56	500	2	-	-	-	-
	87832-6623	89990-7766	89990-5713	89990-5606	1	56	500	2	-	-	-	-
	87832-6662	89990-7766	89990-5713	89990-5606	1	56	500	2	-	-	-	-
	87832-6672	89990-7766	89990-5713	89990-5606	1	56	500	2	-	-	-	-
40	87832-6922	89990-7769	89990-5713	89990-5605	1	56	500	2	-	-	-	-
	87832-6923	89990-7769	89990-5713	89990-5605	1	56	500	2	-	-	-	-
	87832-6962	89990-7769	89990-5713	89990-5605	1	56	500	2	-	-	-	-
	87832-6972	89990-7769	89990-5713	89990-5605	1	56	500	2	-	-	-	-
42	87832-7023	151000-4140	89990-5772	89990-5607	1	72	150	2	1	-	1	Y

THIS DRAWING CONTAINS INFORMATION THAT IS PROPRIETARY TO MOLEX ELECTRONIC TECHNOLOGIES, LLC AND SHOULD NOT BE USED WITHOUT WRITTEN PERMISSION															
<b>QUALITY SYMBOLS</b> 	<b>RE-MASTERED IN ECTR</b> EC NO: 119993 DRWN: MUM CHK'D: GMENARLY REV APPR: KHLIM	<b>GENERAL TOLERANCES (UNLESS SPECIFIED)</b>		<b>DIMENSION UNITS</b> MM      INCH		<b>SCALE</b> NTS									
		4 PLACES ± ±		DRWN BY		DATE									
		3 PLACES ± ±		ATSEE		2015/08/24		<b>PACKAGING SPECIFICATION FOR 87832 IN T&amp;R</b>							
		2 PLACES ± ±		CHK'D BY		DATE									
		1 PLACES ± ±		CGOH		2015/08/24		<b>PACKAGING DESIGN DRAWING</b>							
		0 PLACES ± ±		APP'R BY		DATE									
		ANGULAR TOL = 1.0		KHLIM		2017/05/26		SERIES: 87832		MATERIAL NUMBER: SEE TABLE		CUSTOMER: GENERAL MARKET			
		DRAFT WHERE APPLICABLE MUST REMAIN WITHIN DIMENSIONS		DRAWING SIZE: A3		THIRD ANGLE PROJECTION		DOCUMENT NUMBER: PK-87832-300		DOC TYPE: PDD		DOC PART: 001		SHEET NUMBER: 10 OF 12	

CKTS	PART NUMBER	EMBOSSSED TAPE	REEL	TOP TAPE	OPTION (SEE SHEET 12)	EMBOSS WIDTH	QTY./REEL	REELS/CARTON	BUBBLE SHEETS QTY.			CORNER GUIDES 78888-1251
									TOP	CENTER	BOTTOM	
44	87832-4415	89990-7671	89990-5713	89990-5606	3	56	500	2	-	-	-	-
	87832-7122	89990-7771	89990-5713	89990-5606	1	56	500	2	-	-	-	-
	87832-7123	89990-7771	89990-5713	89990-5606	1	56	500	2	-	-	-	-
	87832-7162	89990-7771	89990-5713	89990-5606	1	56	500	2	-	-	-	-
	87832-7172	89990-7771	89990-5713	89990-5606	1	56	500	2	-	-	-	-
46	87832-7222	89990-7772	89990-5772	89990-5607	1	56	500	2	-	-	-	-
	87832-7262	89990-7772	89990-5772	89990-5607	1	56	500	2	-	-	-	-
	87832-7272	89990-7772	89990-5772	89990-5607	1	56	500	2	-	-	-	-
50	87832-7422	89990-7774	89990-5772	89990-5607	1	56	500	2	-	-	-	-
	87832-7423	89990-7774	89990-5772	89990-5607	1	56	500	2	-	-	-	-
	87832-7462	89990-7774	89990-5772	89990-5607	1	56	500	2	-	-	-	-
	87832-7472	89990-7774	89990-5772	89990-5607	1	56	500	2	-	-	-	-

THIS DRAWING CONTAINS INFORMATION THAT IS PROPRIETARY TO MOLEX ELECTRONIC TECHNOLOGIES, LLC AND SHOULD NOT BE USED WITHOUT WRITTEN PERMISSION																
<b>QUALITY SYMBOLS</b> 	RE-MASTERED IN ELECTR		2017/06/27		2017/08/10		2017/08/10		GENERAL TOLERANCES (UNLESS SPECIFIED)		DIMENSION UNITS		SCALE			
	EC NO: 119993		DRWN: MUM		CHK'D: GMENARLY		REV APPR: KHLIM		MM INCH		MM		NTS			
	4 PLACES ±		±		DRWN BY		DATE		ATSEE		2015/08/24					
	3 PLACES ±		±		CHK'D BY		DATE		CGOH		2015/08/24					
	2 PLACES ±		±		APPR BY		DATE		KHLIM		2017/05/26					
	1 PLACES ±		±		DRAWING SIZE		THIRD ANGLE PROJECTION		A3							
	0 PLACES ±		±		ANGULAR TOL = 1.0		DRAFT WHERE APPLICABLE MUST REMAIN WITHIN DIMENSIONS		SERIES		MATERIAL NUMBER		CUSTOMER			
	A		87832		SEE TABLE		GENERAL MARKET		DOCUMENT NUMBER		DOC TYPE		DOC PART		SHEET NUMBER	
			PK-87832-300		PDD		001		11 OF 12							

# PACKAGING OPTIONS

OPTION 1

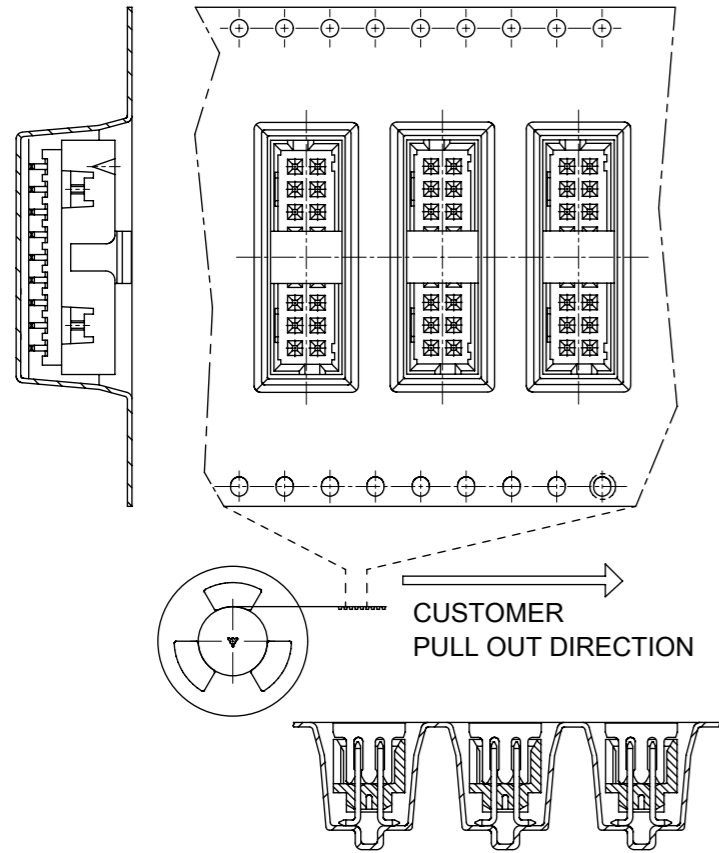

OPTION 2

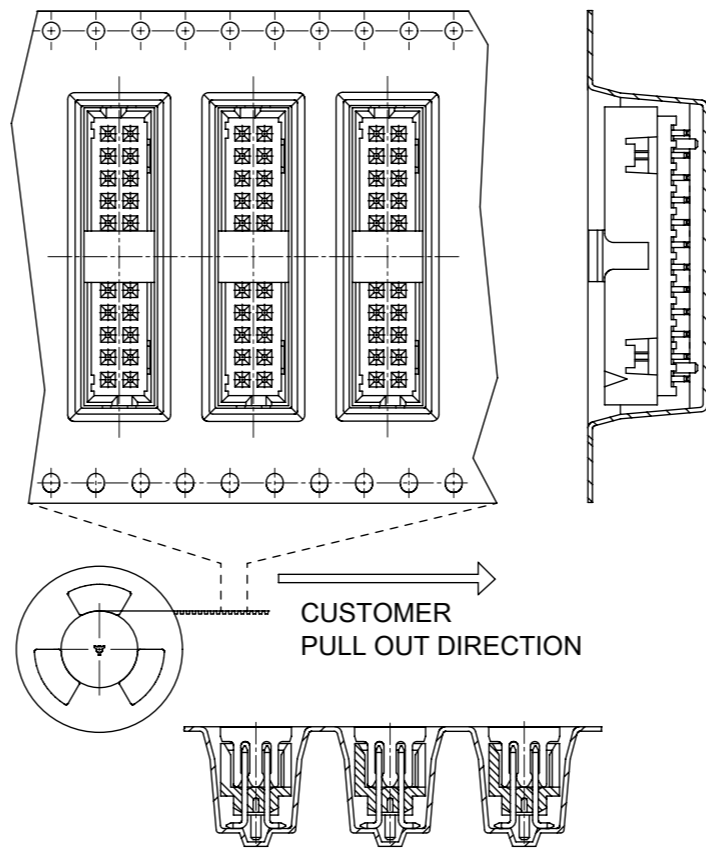

OPTION 3

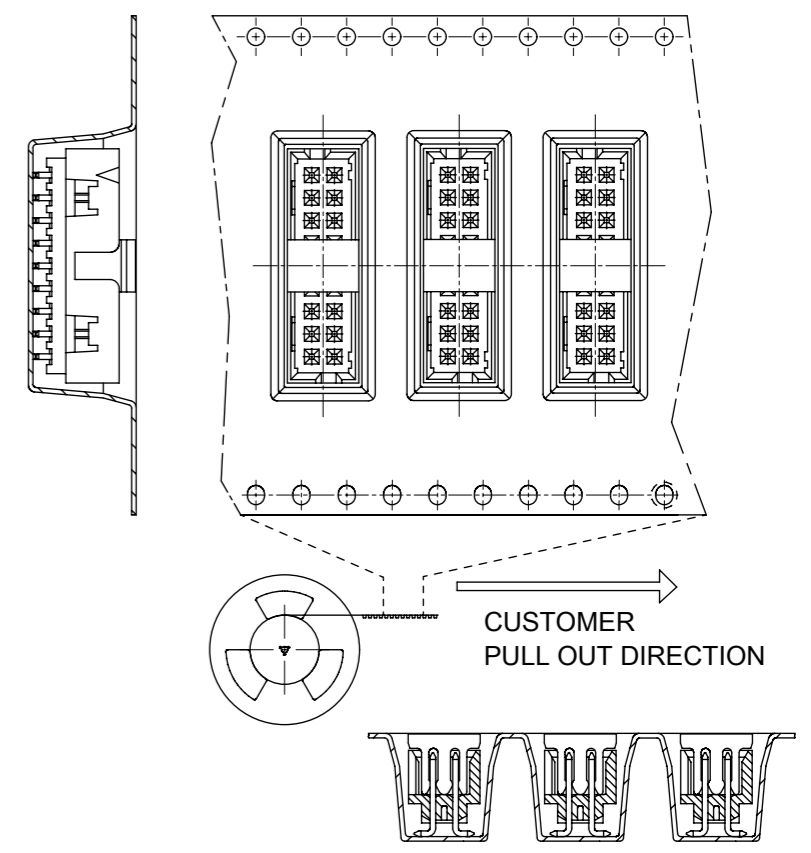

## EMBOSSED TAPE & REEL POCKET DESCRIPTIONS

OPTIONS	CENTER POLARIZATION OPTIONS		PEG OPTIONS		PILOT HOLE OPTIONS	
	ON THE LEFT	ON THE RIGH	WITH PEG	WITHOUT PEG	2 SIDES	1 SIDE
1	YES	N.A	YES	N.A	CKT 12 - 50	CKT 4 - 10
2	N.A	YES	YES	YES	CKT 12 - 50	CKT 4 - 10
3	YES	N.A	N.A	YES	CKT 12 - 50	CKT 4 - 10

<b>QUALITY SYMBOLS</b> 	THIS DRAWING CONTAINS INFORMATION THAT IS PROPRIETARY TO MOLEX ELECTRONIC TECHNOLOGIES, LLC AND SHOULD NOT BE USED WITHOUT WRITTEN PERMISSION													
	RE-MASTERED IN ELECTR EC NO: 119993 DRWN: MUM CHK'D: GMENARLY REV APPR: KHLIM	2017/06/27		2017/08/10		2017/08/10		GENERAL TOLERANCES (UNLESS SPECIFIED)		DIMENSION UNITS		SCALE		
		MM		INCH		MM		NTS		MM		NTS		
		4 PLACES ±		±		3 PLACES ±		±		DRWN BY		DATE		
		2 PLACES ±		±		1 PLACES ±		±		ATSEE		2015/08/24		
		0 PLACES ±		±		0 PLACES ±		±		CHK'D BY		DATE		
	ANGULAR TOL = 1.0		DRAFT WHERE APPLICABLE MUST REMAIN WITHIN DIMENSIONS		A3		THIRD ANGLE PROJECTION		CGOH		2015/08/24			
	APPR BY		DATE		KHLIM		2017/05/26		APPR BY		DATE			
	SERIES		MATERIAL NUMBER		CUSTOMER		DRAWING SIZE		78732		SEE TABLE		GENERAL MARKET	
	DOCUMENT NUMBER		DOC TYPE		DOC PART		SHEET NUMBER		PK-87832-300		PDD		001 12 OF 12	



PACKAGING SPECIFICATION FOR 87832 IN T&R

PACKAGING DESIGN DRAWING