



Chipsmall Limited consists of a professional team with an average of over 10 year of expertise in the distribution of electronic components. Based in Hongkong, we have already established firm and mutual-benefit business relationships with customers from,Europe,America and south Asia,supplying obsolete and hard-to-find components to meet their specific needs.

With the principle of "Quality Parts,Customers Priority,Honest Operation,and Considerate Service",our business mainly focus on the distribution of electronic components. Line cards we deal with include Microchip,ALPS,ROHM,Xilinx,Pulse,ON,Everlight and Freescale. Main products comprise IC,Modules,Potentiometer,IC Socket,Relay,Connector.Our parts cover such applications as commercial,industrial, and automotives areas.

We are looking forward to setting up business relationship with you and hope to provide you with the best service and solution. Let us make a better world for our industry!



Contact us

Tel: +86-755-8981 8866 Fax: +86-755-8427 6832

Email & Skype: info@chipsmall.com Web: www.chipsmall.com

Address: A1208, Overseas Decoration Building, #122 Zhenhua RD., Futian, Shenzhen, China



6

5

4

3

2

1

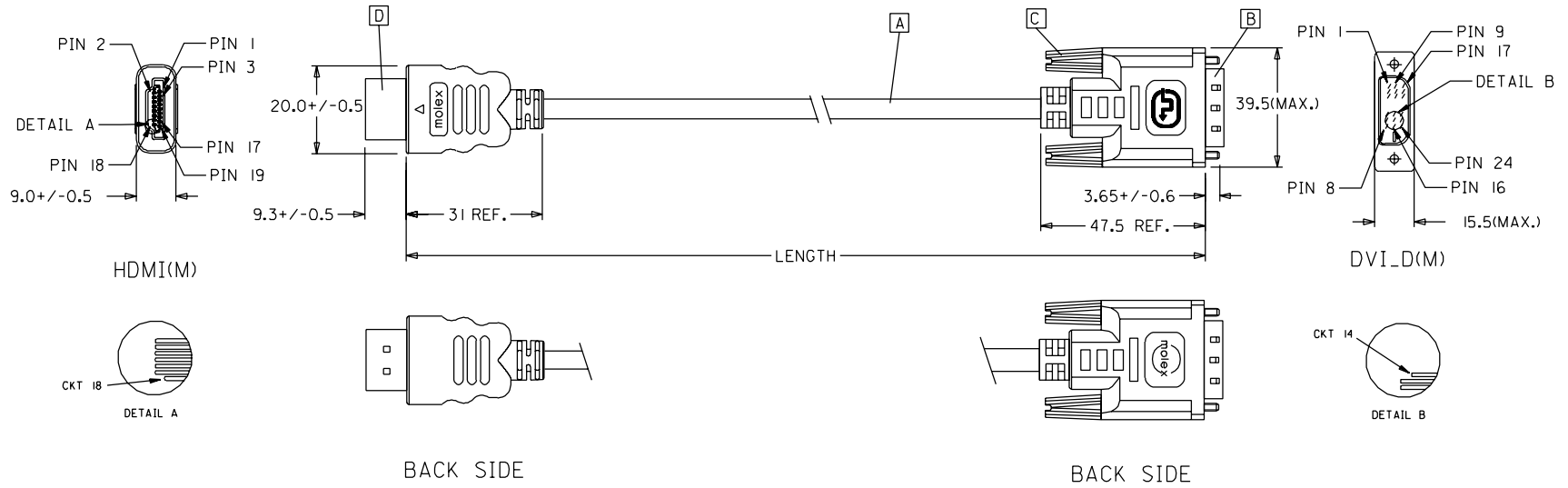

88768-3620	HDMI TO DVI-D(M) CABLE ASS'Y,3M	3000+/-80	BLACK	5,5MM(TMDS - AWG*30)
88768-3610	HDMI TO DVI-D(M) CABLE ASS'Y,2M	2000+/-60	BLACK	5,5MM(TMDS - AWG*30)
88768-3600	HDMI TO DVI-D(M) CABLE ASS'Y,1M	1000+/-30	BLACK	5,5MM(TMDS - AWG*30)
88768-3530	HDMI TO DVI-D(M) CABLE ASS'Y,5M	5000+/-100	BLACK	7,3MM(TMDS - AWG*28)
88768-3520	HDMI TO DVI-D(M) CABLE ASS'Y,3M	3000+/-80	BLACK	7,3MM(TMDS - AWG*28)
88768-3510	HDMI TO DVI-D(M) CABLE ASS'Y,2M	2000+/-60	BLACK	7,3MM(TMDS - AWG*28)
88768-3500	HDMI TO DVI-D(M) CABLE ASS'Y,1M	1000+/-30	BLACK	7,3MM(TMDS - AWG*28)
MX P/N	DESCRIPTION	LENGTH	CABLE COLOR	CABLE OD

EC NO. C	DRWN: CHK: APPR:	DESCRIPTION REV	QUALITY SYMBOLS	GENERAL TOLERANCES: (UNLESS SPECIFIED)		SCALE N.S.T	DESIGN UNITS <input checked="" type="checkbox"/> mm <input type="checkbox"/> INCH	THIRD ANGLE PROJECTION <input type="checkbox"/> mm <input type="checkbox"/> INCH <input checked="" type="checkbox"/> mm ONLY	SHT REV
			MAJOR ▼ = 0 CRITICAL ▽ = 0	mm	INCH	DRAWN BY & DATE Louis Chen 03/11/17	TITLE: HDMI(M) TO DVI-D(M) CABLE ASS'Y		REVISION CAD ONLY
			4 PLACES ±0.	±.		CHECKED BY & DATE Teddy Kan 03/11/17	APPROVED BY & DATE Baron Chen 03/11/17		MATERIAL NO. SEE TABLE
			3 PLACES ±0.	±.		MOLEX INCORPORATED		DRAWING NO. SD-88768-001	
			2 PLACES ±0.	±.		CAD FILENAME S88768AA.SOI	SHEET NO. 1 OF 2		SIZE A4
			1 PLACE ±0.	±.		THIS DRAWING CONTAINS INFORMATION THAT IS PROPRIETARY TO MOLEX INCORPORATED AND SHOULD NOT BE USED WITHOUT WRITTEN PERMISSION.			

6

5

4

3

2

1

NOTE: 1. OVERMOLD SPECIFICATION

1.1 DVI BOOT MOLDED WITH SNOW WHITE PVC RESIN P/N.

1.1.1 UL94V-0

1.1.2 HARDNESS (DUROMETER): SHORE A 90-95

1.2 HDMI OUTER MOLD WITH BLACK PVC RESIN. UL94V-0.

2. MECHANICAL SPECIFICATION

2.1 CABLE SHOULD STAND THE PULL FORCE 89-11IN FOR 30 SECONDS WITH NO VISIBLE TERMINATION DAMAGE.

2.2 CABLE SHOULD PASS THE FLEX TEST IN 100 CYCLES AT EACH OF PLANES, PER EIA 364-41, CONDITION 1.

3. CABLE ELECTRICAL SPECIFICATION

3.1 DIELECTRIC STRENGTH: 300V AC FOR 10MS.

3.2 INSULATION RESISTANCE: 10 MEGA Ohms MIN.

3.3 DIFFERENTIAL LINES CHARACTERISTIC IMPEDANCE: 100+/-10 Ohms @TDR.

3.4 CONTACT RESISTANCE: 2 OHMS(MAX.).

3.5 SIGNALS CROSSTALK(FEXT): 5% (MAX.) PER ANSI/EIA-364-90.







3.6 SIGNALS INTRA-PAIR SKEW : <150 ps.

4. DVI CONNECTOR SPECIFICATION

4.1 REFER TO PRODUCT SPEC. PS74320-0001.

4.2 CONTACT PLATING: AU FLASH.

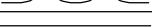
5. MATERIAL MUST MEET MANAGEMENT REGULATIONS FOR ENVIRONMENT (MX TS-0002).

SHIELD	SHIELD		GROUND
PIN 19	PIN 16	=====	HOT PLUG DETECT
PIN 18	PIN 14	=====	POWER +5V
PIN 17	PIN 15	=====	GROUND(+5V&DDC)
PIN 16	PIN 7	=====	DDC DATA(SDA)
PIN 15	PIN 6	=====	DDC CLOCK(SCL)
PIN 11	PIN 22	=====	TMDS CLOCK SHIELD
PIN 12	PIN 24		TMDS CLOCK-
PIN 10	PIN 23		TMDS CLOCK+
PIN 8	PIN 19	=====	TMDS DATA 0 SHIELD
PIN 9	PIN 17		TMDS DATA 0-
PIN 7	PIN 18		TMDS DATA 0+
PIN 5	PIN 11	=====	TMDS DATA 1 SHIELD
PIN 6	PIN 9		TMDS DATA 1-
PIN 4	PIN 10		TMDS DATA 1+
PIN 2	PIN 3	=====	TMDS DATA 2 SHIELD
PIN 3	PIN 1		TMDS DATA 2-
PIN 1	PIN 2		TMDS DATA 2+
HDMI	DVI-D	COLOR	CABLE FUNCTION

ITEM	DESCRIPTION	QTY.
D	HDMI PLUG ASSY'	1
C	DVI THUMB SCREW	2
B	DVI_D SINGLE CHANNEL G/F CONNECTOR	1
A	DVI SINGLE LINK CABLE (SEE TABLE)	1

EC NO. DRWN: CHK: APPR: C	DESCRIPTION REV	QUALITY SYMBOLS MAJOR ▼ = 0 CRITICAL ▽ = 5	GENERAL TOLERANCES: (UNLESS SPECIFIED) <table border="1"> <thead> <tr> <th></th> <th>mm</th> <th>INCH</th> </tr> </thead> <tbody> <tr> <td>4 PLACES</td> <td>±0.</td> <td>±.</td> </tr> <tr> <td>3 PLACES</td> <td>±0.</td> <td>±.</td> </tr> <tr> <td>2 PLACES</td> <td>±0.</td> <td>±.</td> </tr> <tr> <td>1 PLACE</td> <td>±0.</td> <td>±.</td> </tr> </tbody> </table>		mm	INCH	4 PLACES	±0.	±.	3 PLACES	±0.	±.	2 PLACES	±0.	±.	1 PLACE	±0.	±.	SCALE N.S.T DESIGN UNITS <input checked="" type="checkbox"/> mm <input type="checkbox"/> INCH THIRD ANGLE PROJECTION <input type="checkbox"/> mm INCH <input type="checkbox"/> INCH mm <input checked="" type="checkbox"/> mm ONLY	SHT REV
			mm	INCH																
		4 PLACES	±0.	±.																
		3 PLACES	±0.	±.																
2 PLACES	±0.	±.																		
1 PLACE	±0.	±.																		
DRAWN BY & DATE Louis Chen 03/11/17		TITLE: HDMI(M) TO DVI-D(M) CABLE ASS'Y		REVISION CAD ONLY																
CHECKED BY & DATE Teddy Kan 03/11/17		APPROVED BY & DATE Boron Chen 03/11/17		MOLEX INCORPORATED																
CAD FILENAME S88768AA.S02		MATERIAL NO. SEE TABLE	DRAWING NO. SD-88768-001	SHEET NO. 2 OF 2																

THIS DRAWING CONTAINS INFORMATION THAT IS PROPRIETARY TO MOLEX INCORPORATED AND SHOULD NOT BE USED WITHOUT WRITTEN PERMISSION.

SIZE A4

REVISIONS				
ECN NO	DATE	REV.	DESCRIPTION	CHANGER
CY14-5154	2013/08/30	G	CHANGE THE LABELING CONTENT AND UPDATE NOTE FOR PRODUCTS TRANSFER TO PHILIPPINES	AHOU

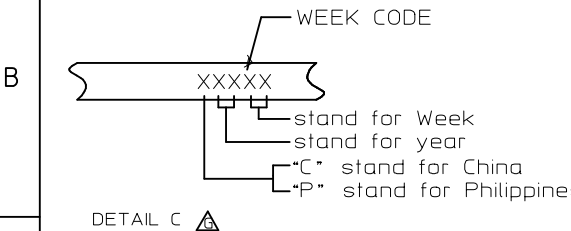
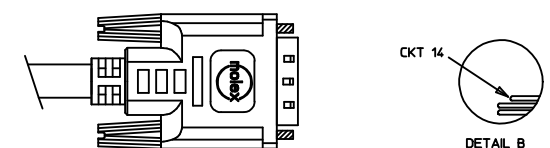
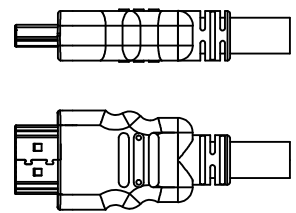
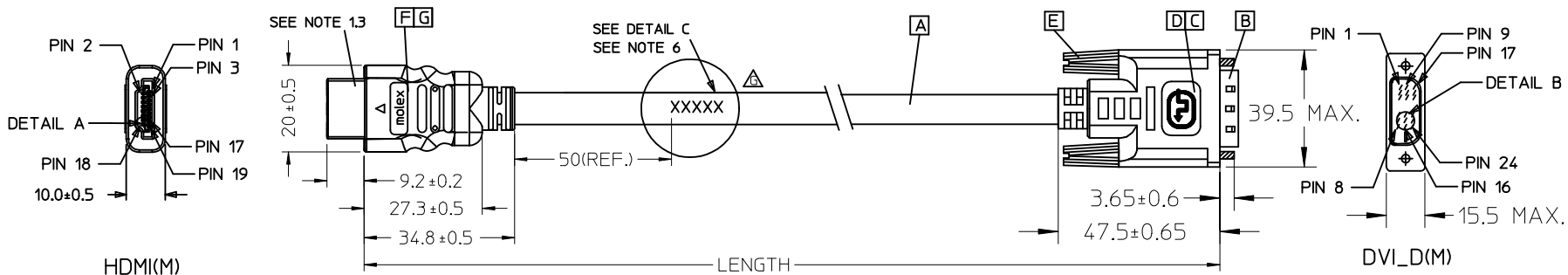

887683530	HDMI TO DVI-D(M) CABLE ASS'Y.5M	5000 ± 100	BLACK	7.3MM(TMDS - AWG#28)
887683520	HDMI TO DVI-D(M) CABLE ASS'Y.3M	3000 ± 80	BLACK	7.3MM(TMDS - AWG#28)
887683510	HDMI TO DVI-D(M) CABLE ASS'Y.2M	2000 ± 60	BLACK	7.3MM(TMDS - AWG#28)
887683500	HDMI TO DVI-D(M) CABLE ASS'Y.1M	1000 ± 30	BLACK	7.3MM(TMDS - AWG#28)
MX P/N	DESCRIPTION	LENGTH	CABLE COLOR	CABLE OD

ENTER DESCRIPTION EC NO: CPG2014-0686 DRWN: XJGU001 CHKD: AHOU APPR: XAWANG 2013/09/06 2013/09/06 2013/09/12	QUALITY SYMBOLS ▽=0 ◻=0	GENERAL TOLERANCES (UNLESS SPECIFIED)		DIMENSION STYLE MM ONLY		SCALE ---	DESIGN UNITS METRIC	THIRD ANGLE PROJECTION	
			mm	INCH	DRAWN BY	DATE	TITLE HDMI(M) TO DVI-D(M) CABLE ASS'Y		
		4 PLACES	± ---	± ---	FZHANG01	2011/05/05			
		3 PLACES	± ---	± ---	CHECKED BY	DATE			
2 PLACES	± ---	± ---	YHXU	2011/05/05	MOLEX INCORPORATED		SHEET NO. 1 OF 2		
1 PLACE	± ---	± ---	APPROVED BY	DATE					
ANGULAR ± ---°		DRAFT WHERE APPLICABLE MUST REMAIN WITHIN DIMENSIONS		MATERIAL NO. 8876835xx		DOCUMENT NO. SD-88768-35XX			
SIZE A 4		THIS DRAWING CONTAINS INFORMATION THAT IS PROPRIETARY TO MOLEX INCORPORATED AND SHOULD NOT BE USED WITHOUT WRITTEN PERMISSION							

△ NOTE:

1. OVERMOLD SPECIFICATION:
 - 1.1 DVI BOOT MOLDED SNOW WHITE PVC RESIN 887800076, UL94V-0.
 - 1.2 HDMI INNER MOLDED WITH PVC RESIN
HDMI OUTER MOLDED WITH PVC RESIN
 - 1.3 DUST COVER MOLDED WITH PE
2. THE CODE PLEASE BE PRINTED ON THE SPACE
3. PRODUCT ELECTRICAL SPECIFICATION:
 - 3.1 HI-POT VOLTAGE: 300V DC FOR 10mS
 - 3.2 INSULATION RESISTANCE: 10 MEGA Ohms MIN.
 - 3.3 CONTACT RESISTANCE: 2 OHMS MAX. FOR 1&2&3M; 3 OHMS MAX. FOR 5M;
 - 3.4 DIFFERENTIAL LINES CHARACTERISTIC IMPEDANCE: 100± 10 Ohms @TDR.
 - 3.5 SIGNALS CROSSTALK (FEXT) : 5% (MAX.) PER ANSI/EIA-364-90.
 - 3.6 SIGNALS INTRA-PAIR SKEW(PER CABLE): <150PS.
4. DVI CONNECTOR SPECIFICATION:
 - 4.1 REFER TO PRODUCT SPEC. PS74320-001
 - 4.2 CONTACT PLATING: AU FLASH.
5. THIS PRODUCT MUST MEET THE EU RoHS CHEMICAL SUBSTANCES SPECIFICATION FOR PRODUCTS (EU 2002/95/EC).
6. THE CODE PLEASE BE PRINTED ON THE SPACE.

SHIELD	SHIELD	OVERALL SHIELD	GROUND
PIN 19	PIN 16	WHITE	HOT PLUG DETECT
PIN 18	PIN 14	YELLOW	POWER +5V
PIN 17	PIN 15	ORANGE	GROUND(+5V&DDC)
PIN 16	PIN 7	RED	DDC DATA(SDA)
PIN 15	PIN 6	VIOLET	DDC CLOCK(SCL)
PIN 12	PIN 24	WHITE	TMDS CLOCK-
PIN 11	PIN 22	BRAID	TMDS CLOCK SHIELD
PIN 10	PIN 23	BROWN	TMDS CLOCK+
PIN 9	PIN 17	WHITE	TMDS DATA 0-
PIN 8	PIN 19	BRAID	TMDS DATA 0 SHIELD
PIN 7	PIN 18	BLUE	TMDS DATA 0+
PIN 6	PIN 9	WHITE	TMDS DATA 1-
PIN 5	PIN 11	BRAID	TMDS DATA 1 SHIELD
PIN 4	PIN 10	GREEN	TMDS DATA 1+
PIN 3	PIN 1	WHITE	TMDS DATA 2-
PIN 2	PIN 3	BRAID	TMDS DATA 2 SHIELD
PIN 1	PIN 2	RED	TMDS DATA 2+
HDMI	DVI-D	COLOR	CABLE FUNCTION

G	HDMI 19P MALE,30U"Au Solder Type	1
F	Metal Shell For HDMI 19P Male	1
E	DVI THUMB SCREW	2
D	PCB	1
C	ONE BODY CAN	1
B	DVI_D SINGLE CHANNEL G/F CONNECTOR	1
A	DVI SINGLE LINK CABLE (SEE TABLE)	1
ITEM	DESCRIPTION	QTY.

ENTER DESCRIPTION EC NO: CPG2014-0686 DRW: XJGU001 CHKD: AHOU APPR: XAWANG	2013/09/06 2013/09/06 2013/09/12	DESCRIPTION REV	QUALITY SYMBOLS ▽=0 ▽=0	GENERAL TOLERANCES (UNLESS SPECIFIED)		DIMENSION STYLE MM ONLY		SCALE ---	DESIGN UNITS METRIC	THIRD ANGLE PROJECTION			
DRAFT WHERE APPLICABLE MUST REMAIN WITHIN DIMENSIONS				DRAWN BY DATE FZHANG01 2011/05/05		CHECKED BY DATE YHXU 2011/05/05		APPROVED BY DATE ZXDENG 2011/05/11		TITLE HDMI(M) TO DVI-D(M) CABLE ASS'Y			
				MATERIAL NO. 8876835xx		DOCUMENT NO. SD-88768-35XX		SHEET NO. 2 OF 2		MOLEX INCORPORATED			
				SIZE A4		THIS DRAWING CONTAINS INFORMATION THAT IS PROPRIETARY TO MOLEX INCORPORATED AND SHOULD NOT BE USED WITHOUT WRITTEN PERMISSION							

7 6 5 4 3 2 1

E

D

C

B

A

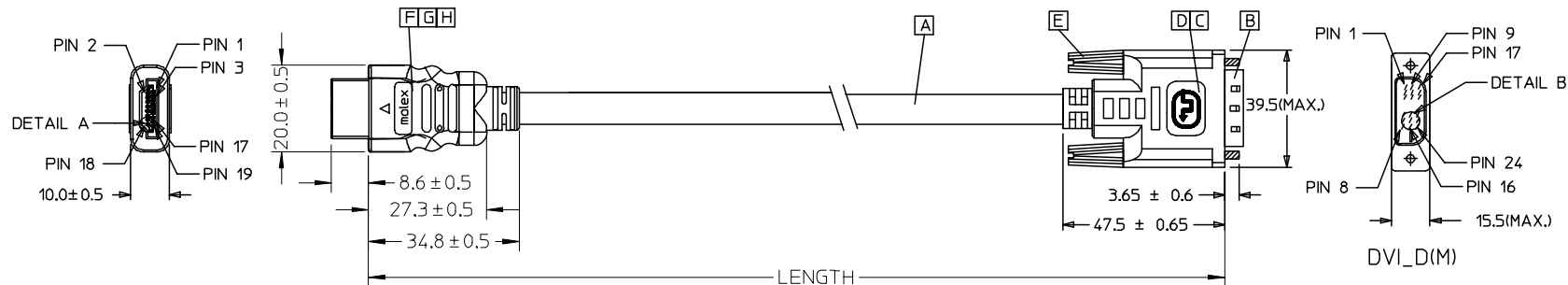

HDMI(M)

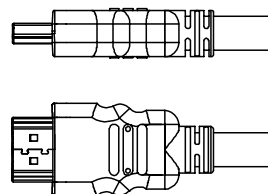
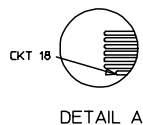

BACK SIDE

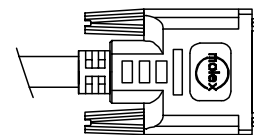

BACK SIDE

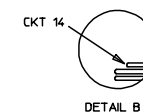

88768-3530	HDMI TO DVI-D(M) CABLE ASS'Y.5M	5000 ± 100	BLACK	7.3MM(TMDS - AWG#28)	887808276
88768-3520	HDMI TO DVI-D(M) CABLE ASS'Y.3M	3000 ± 80	BLACK	7.3MM(TMDS - AWG#28)	887808276
88768-3510	HDMI TO DVI-D(M) CABLE ASS'Y.2M	2000 ± 60	BLACK	7.3MM(TMDS - AWG#28)	887808276
88768-3500	HDMI TO DVI-D(M) CABLE ASS'Y.1M	1000 ± 30	BLACK	7.3MM(TMDS - AWG#28)	887808276
MX P/N	DESCRIPTION	LENGTH	CABLE COLOR	CABLE OD	CABLE P/N

ENTER DESCRIPTION EC NO: DG2006-0144 DRWN: JFZHENG CHKD: APPR: DQLUO	QUALITY SYMBOLS ▽=0 ◻=0	GENERAL TOLERANCES (UNLESS SPECIFIED)		DIMENSION STYLE MM ONLY		SCALE ---	DESIGN UNITS METRIC	THIRD ANGLE PROJECTION	
			mm	INCH	DRAWN BY	DATE	TITLE		
		4 PLACES	± ---	± ---	JFZHENG	2005/12/26	#28 HDMI TO DVI 1M CABLE ASS'Y		
		3 PLACES	± ---	± ---	CHECKED BY	DATE	MOLEX MOLEX INCORPORATED		
2 PLACES	± ---	± ---	JFZHENG	2005/12/26	MATERIAL NO. DOCUMENT NO. SHEET NO.				
1 PLACE	± ---	± ---	APPROVED BY	DATE	ENTER PART SD-887683520 1 OF 00				
ANGULAR ± ---°		DRAFT WHERE APPLICABLE MUST REMAIN WITHIN DIMENSIONS		SIZE		THIS DRAWING CONTAINS INFORMATION THAT IS PROPRIETARY TO MOLEX INCORPORATED AND SHOULD NOT BE USED WITHOUT WRITTEN PERMISSION			

6

5

4

3

2

1

NOTE:
 1. OVERMOLD SPECIFICATION:
 1.1 DVI BOOT MOLDED SNOW WHITE PVC RESIN 887800076,UL94V-0.
 1.2 HDMI INNERMOLD WITH BK PVC 887800019.
 HDMI OVERMOLD WITH PVC 887800150
 1.3 HDMI DUST COVER WITH PE 887800008

2. MECHANICAL SPECIFICATION
 2.1 CABLE SHOULD STAND THE PULL FORCE 89-111N FOR 30 SECONDS WITH NO VISIBLE TERMINATION DAMAGE.
 2.2 CABLE SHOULD PASS THE FLEX TEST IN 100 CYCLES AT EACH OF PLANES, PER EIA 364-41, CONDITION 1.
 3. PRODUCT ELECTRICAL SPECIFICATION:
 3.1 DIELECTRIC STRENGTH.
 3.2 INSULATION RESISTANCE.
 3.3 CONDUCTIVE RESISTANCE.
 3.4 TMDS Signals Time Domain Impedence
 3.5 TMDS Signals Time Domain Crosstalk:FEXT
 3.6 TMDS Signals Skew
 3.7 Attenuation
 REFER TO ES-002 ELECTRICAL SPECIFICATION FOR DETAILS.
 4.CABLE CONSTRUCTION(CABLE
 (AWG#28*1P+D)*4 + AWG#28*1P + AWG#28*3C, 7.3MMOD
 5. DVI CONNECTOR SPECIFICATION(DVI
 5.1 REFER TO PRODUCT SPEC. PS74320-001
 5.2 CONTACT PLATING: AU FLASH.
 6. THIS PRODUCT MUST MEET ROHS COMPLIANCE.

SHIELD	SHIELD	OVERALL SHIELD	GROUND
PIN 19	PIN 16	WHITE	HOT PLUG DETECT
PIN 18	PIN 14	YELLOW	POWER +5V
PIN 17	PIN 15	ORANGE	GROUND(+5V&DDC)
PIN 16	PIN 7	RED	DDC DATA(SDA)
PIN 15	PIN 6	VIOLET	DDC CLOCK(SCL)
PIN 12	PIN 24	WHITE	TMDS CLOCK-
PIN 11	PIN 22	BRAID	TMDS CLOCK SHIELD
PIN 10	PIN 23	BROWN	TMDS CLOCK+
PIN 9	PIN 17	WHITE	TMDS DATA 0-
PIN 8	PIN 19	BRAID	TMDS DATA 0 SHIELD
PIN 7	PIN 18	BLUE	TMDS DATA 0+
PIN 6	PIN 9	WHITE	TMDS DATA 1-
PIN 5	PIN 11	BRAID	TMDS DATA 1 SHIELD
PIN 4	PIN 10	GREEN	TMDS DATA 1+
PIN 3	PIN 1	WHITE	TMDS DATA 2-
PIN 2	PIN 3	BRAID	TMDS DATA 2 SHIELD
PIN 1	PIN 2	RED	TMDS DATA 2+
HDMI	DVI-D	COLOR	CABLE FUNCTION

ITEM	DESCRIPTION	QTY.
H	HDMI METAL PLATED 47152-6009	1
G	HDMI METAL CAN 47152-4001	1
F	HDMI HOUSING ASSY' 47152-1100	1
E	DVI THUMB SCREW 887806077	2
D	PCB 887899569/887899570	1
C	ONE BODY CAN 887899392	1
B	DVI_D SINGLE CHANNEL G/F CONNECTOR 743230001	1
A	DVI SINGLE LINK CABLE (SEE TABLE)	1

ENTER DESCRIPTION EC NO: DG2006-0144 DRWN: JFZHENG CHKD: APPR: DQLUO	2005/12/27 2005/12/30 2006/01/16	QUALITY SYMBOLS ▽=0 ▽=5	GENERAL TOLERANCES (UNLESS SPECIFIED)		DIMENSION STYLE MM ONLY		SCALE ---	DESIGN UNITS METRIC	THIRD ANGLE PROJECTION		
				mm	INCH	DRAWN BY JFZHENG	DATE 2005/12/26	TITLE #28 HDMI TO DVI 1M CABLE ASS'Y			
			4 PLACES	±---	±---	CHECKED BY JFZHENG	DATE 2005/12/26				
			3 PLACES	±---	±---	APPROVED BY DQLUO	DATE 2005/12/26	MOLEX MOLEX INCORPORATED			
2 PLACES	±---	±---	ANGULAR ±---°		MATERIAL NO.	DOCUMENT NO. SD-887683520	SHEET NO. 2 OF 2				
1 PLACE	±---	±---	DRAFT WHERE APPLICABLE MUST REMAIN WITHIN DIMENSIONS		SIZE A4	THIS DRAWING CONTAINS INFORMATION THAT IS PROPRIETARY TO MOLEX INCORPORATED AND SHOULD NOT BE USED WITHOUT WRITTEN PERMISSION					

7 6 5 4 3 2 1

E
D
C
B
A

E
D
C
B
A

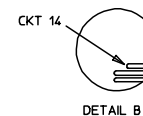
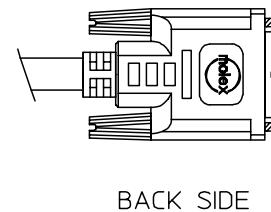
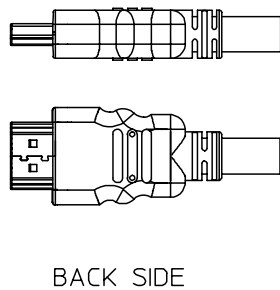
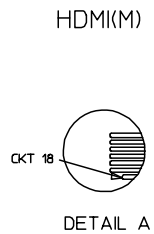
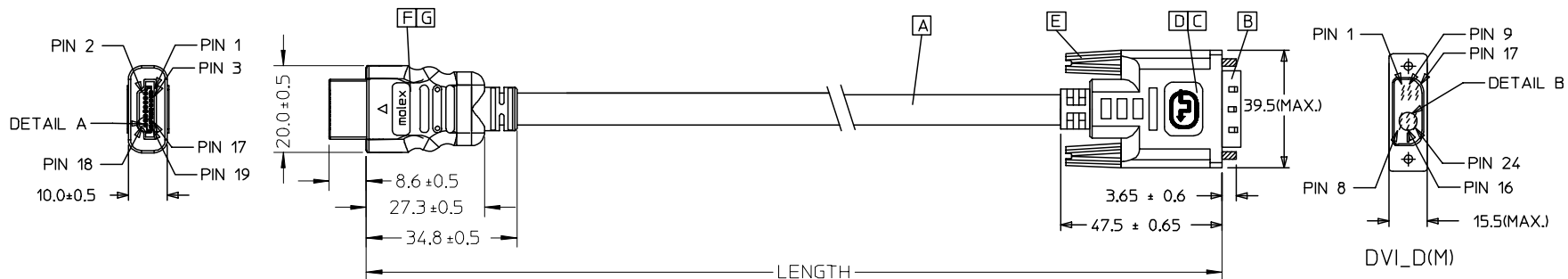

88768-3530	HDMI TO DVI-DIM) CABLE ASS'Y,5M	5000 ± 100	BLACK	7.3MM(TMDS - AWG#28)	887808276
88768-3520	HDMI TO DVI-DIM) CABLE ASS'Y,3M	3000 ± 80	BLACK	7.3MM(TMDS - AWG#28)	887808276
88768-3510	HDMI TO DVI-DIM) CABLE ASS'Y,2M	2000 ± 60	BLACK	7.3MM(TMDS - AWG#28)	887808276
88768-3500	HDMI TO DVI-DIM) CABLE ASS'Y,1M	1000 ± 30	BLACK	7.3MM(TMDS - AWG#28)	887808276
MX P/N	DESCRIPTION	LENGTH	CABLE COLOR	CABLE OD	CABLE P/N

ENTER DESCRIPTION EC NO: DG2005-0094 DRWN: JLIU13 2005/01/18 CHKD: TEDDY 2005/01/18 APPR: TKAN 2005/01/20	QUALITY SYMBOLS ▽=0 ◻=0	GENERAL TOLERANCES (UNLESS SPECIFIED)		DIMENSION STYLE MM ONLY		SCALE ---	DESIGN UNITS METRIC	THIRD ANGLE PROJECTION		
			mm	INCH	DRAWN BY JLIU13	DATE 2005/01/18	TITLE #28 HDMI TO DVI 3M CABLE ASS'Y			
		4 PLACES	± ---	± ---	CHECKED BY TEDDY	DATE 2005/01/18	APPROVED BY BORON 2005/01/18			
		3 PLACES	± ---	± ---	APPROVED BY BORON 2005/01/18		MATERIAL NO. 887683520			
			2 PLACES	± ---	± ---	DOCUMENT NO. SD887683520				
			1 PLACE	± ---	± ---	SHEET NO. 1 OF 2				
			ANGULAR ± ---°		THIS DRAWING CONTAINS INFORMATION THAT IS PROPRIETARY TO MOLEX INCORPORATED AND SHOULD NOT BE USED WITHOUT WRITTEN PERMISSION					
DRAFT WHERE APPLICABLE MUST REMAIN WITHIN DIMENSIONS										

6 5 4 3 2 1

7 6 5 4 3 2 1

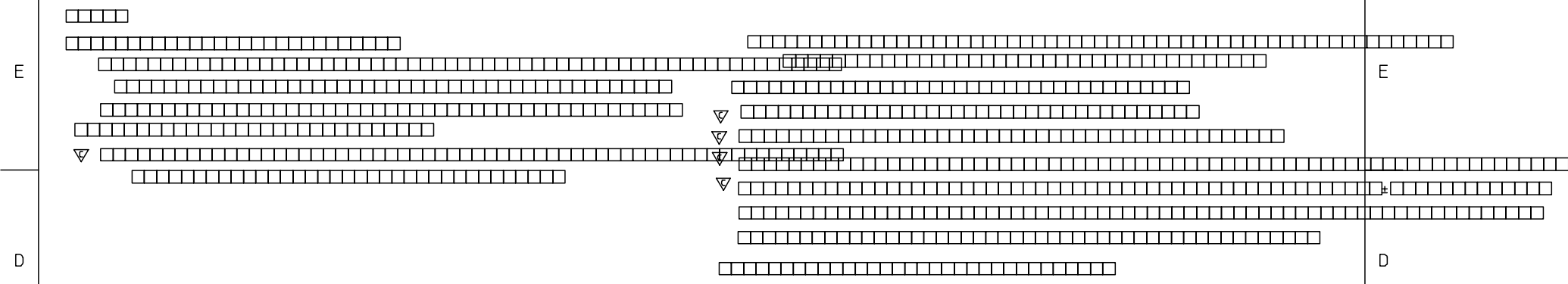

SHIELD	SHIELD	OVERALL SHIELD	GROUND
PIN 19	PIN 16	WHITE	HOT PLUG DETECT
PIN 18	PIN 14	YELLOW	POWER +5V
PIN 17	PIN 15	ORANGE	GROUND(+5V&DDC)
PIN 16	PIN 7	RED	DDC DATA(SDA)
PIN 15	PIN 6	VIOLET	DDC CLOCK(SCL)
PIN 12	PIN 24	WHITE	TMDS CLOCK-
PIN 11	PIN 22	BRAID	TMDS CLOCK SHIELD
PIN 10	PIN 23	BROWN	TMDS CLOCK+
PIN 9	PIN 17	WHITE	TMDS DATA 0-
PIN 8	PIN 19	BRAID	TMDS DATA 0 SHIELD
PIN 7	PIN 18	BLUE	TMDS DATA 0+
PIN 6	PIN 9	WHITE	TMDS DATA 1-
PIN 5	PIN 11	BRAID	TMDS DATA 1 SHIELD
PIN 4	PIN 10	GREEN	TMDS DATA 1+
PIN 3	PIN 1	WHITE	TMDS DATA 2-
PIN 2	PIN 3	BRAID	TMDS DATA 2 SHIELD
PIN 1	PIN 2	RED	TMDS DATA 2+
HDMI	DVI-D	COLOR	CABLE FUNCTION

G	HDMI METAL CAN 5011840118	1
F	HDMI HOUSING ASSY' 5011850001	1
E	DVI THUMB SCREW 887806077	2
D	PCB 887899569/887899570	1
C	ONE BODY CAN 887899392	1
B	DVI_D SINGLE CHANNEL G/F CONNECTOR 743230001	1
A	DVI SINGLE LINK CABLE (SEE TABLE)	1
ITEM	DESCRIPTION	QTY.

ENTER DESCRIPTION EC NO: DG2005-0094 DRWN: JLIU13 CHKD: TEDDY APPR: TKAN 2005/01/18 2005/01/18 2005/01/20 D	QUALITY SYMBOLS ▽=0 ▽=5	GENERAL TOLERANCES (UNLESS SPECIFIED)		DIMENSION STYLE MM ONLY		SCALE ---	DESIGN UNITS METRIC	THIRD ANGLE PROJECTION	
		4 PLACES ±--- ±---	3 PLACES ±--- ±---	2 PLACES ±--- ±---	1 PLACE ±--- ±---	ANGULAR ±---°	DRAWN BY JLIU13	DATE 2005/01/18	TITLE #28 HDMI TO DVI 3M CABLE ASS'Y
		DRAFT WHERE APPLICABLE MUST REMAIN WITHIN DIMENSIONS		CHECKED BY TEDDY	DATE 2005/01/18	APPROVED BY BORON	DATE 2005/01/18	MOLEX INCORPORATED	
				MATERIAL NO. 887683520	DOCUMENT NO. SD887683520	SHEET NO. 2 OF 2			

6 5 4 3 2 1