



Chipsmall Limited consists of a professional team with an average of over 10 year of expertise in the distribution of electronic components. Based in Hongkong, we have already established firm and mutual-benefit business relationships with customers from,Europe,America and south Asia,supplying obsolete and hard-to-find components to meet their specific needs.

With the principle of “Quality Parts,Customers Priority,Honest Operation,and Considerate Service”,our business mainly focus on the distribution of electronic components. Line cards we deal with include Microchip,ALPS,ROHM,Xilinx,Pulse,ON,Everlight and Freescale. Main products comprise IC,Modules,Potentiometer,IC Socket,Relay,Connector.Our parts cover such applications as commercial,industrial, and automotives areas.

We are looking forward to setting up business relationship with you and hope to provide you with the best service and solution. Let us make a better world for our industry!



Contact us

Tel: +86-755-8981 8866 Fax: +86-755-8427 6832

Email & Skype: info@chipsmall.com Web: www.chipsmall.com

Address: A1208, Overseas Decoration Building, #122 Zhenhua RD., Futian, Shenzhen, China



RPC-1.85 Attenuator
RPC-1.85 Plug - RPC-1.85 Jack

08AS102-K06S3

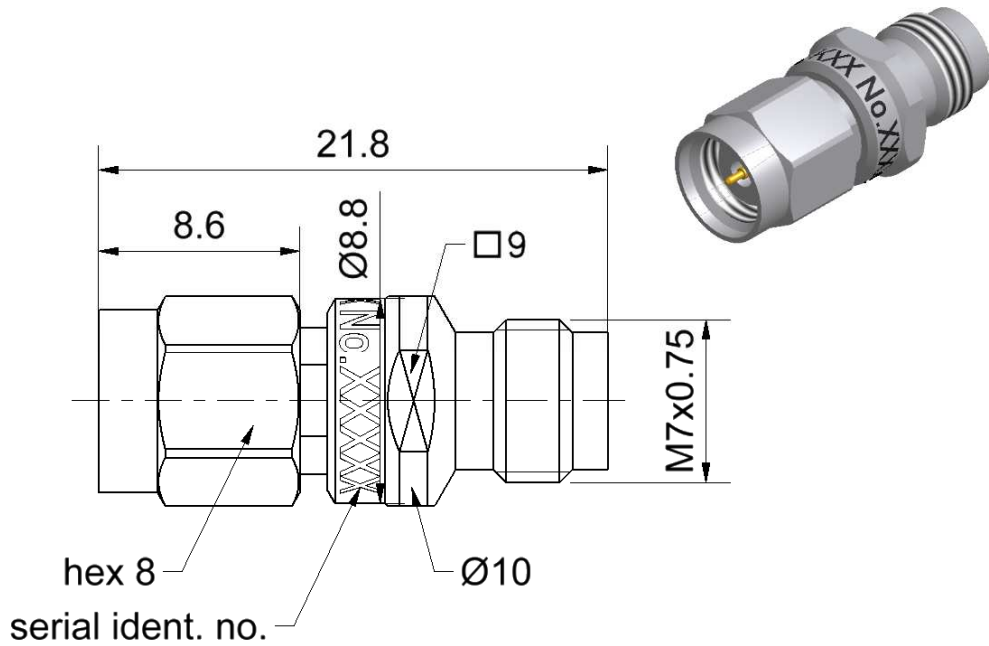

All dimensions are in mm; tolerances according to ISO 2768 m-H

Interface

According to IEC 60169-32
Mechanically compatible with RPC-2.40

Documents

N/A

Material and plating

Connector parts

Center conductor - plug
Center conductor - jack
Outer conductor
Coupling nut
Dielectric
Substrate

Material

CuBe
CuBe
Stainless steel
Stainless steel
PS
Al₂O₃

Plating

Gold, min. 1.27 µm, over nickel
Gold, min. 1.27 µm, over nickel
Passivated
Passivated

Dieses Dokument ist urheberrechtlich geschützt • This document is protected by copyright • Rosenberger Hochfrequenztechnik GmbH & Co. KG

RF_35/05:10/6.0

RPC-1.85

Attenuator
RPC-1.85 Plug - RPC-1.85 Jack

08AS102-K06S3

Electrical data

Impedance 50 Ω
 Frequency range DC to 67 GHz
 Return loss ≥ 32 dB, DC to 4 GHz
 ≥ 25 dB, 4 GHz to 26.5 GHz
 ≥ 18 dB, 26.5 GHz to 37 GHz
 ≥ 12 dB, 37 GHz to 67 GHz
 Attenuation 6 dB ± 0.5 dB, DC to 26.5 GHz
 6 dB ± 1.0 dB, 26.5 GHz to 50 GHz
 6 dB ± 1.5 dB, 50 GHz to 67 GHz
 Power handling 0.5 W at 25°C

Mechanical data

Mating cycles ≥ 500
 Maximum torque 1.65 Nm
 Recommended torque 0.90 Nm
 Gauge 0.00 mm to 0.03 mm

Environmental data

Operating temperature range¹ +20 °C to +26 °C
 Storage temperature range 0 °C to +50 °C
 RoHS compliant

¹ Temperature range over which these specifications are valid.

Packing

Standard 1 pce in box
 Weight 6.9 g/pce

While the information has been carefully compiled to the best of our knowledge, nothing is intended as representation or warranty on our part and no statement herein shall be construed as recommendation to infringe existing patents. In the effort to improve our products, we reserve the right to make changes judged to be necessary.

Draft	Date	Approved	Date	Rev.	Engineering change number	Name	Date
Marcel Panicke	17.01.08	Lars Ramtke	18.06.15	c00	15-0783	Marion Striegler	18.06.15

Rosenberger Hochfrequenztechnik GmbH & Co. KG P.O.Box 1260 D-84526 Tittmoning Germany www.rosenberger.de	Tel. : +49 8684 18-0 Email : info@rosenberger.de	Page 2 / 2
--	---	---------------