



Chipsmall Limited consists of a professional team with an average of over 10 year of expertise in the distribution of electronic components. Based in Hongkong, we have already established firm and mutual-benefit business relationships with customers from,Europe,America and south Asia,supplying obsolete and hard-to-find components to meet their specific needs.

With the principle of “Quality Parts,Customers Priority,Honest Operation,and Considerate Service”,our business mainly focus on the distribution of electronic components. Line cards we deal with include Microchip,ALPS,ROHM,Xilinx,Pulse,ON,Everlight and Freescale. Main products comprise IC,Modules,Potentiometer,IC Socket,Relay,Connector.Our parts cover such applications as commercial,industrial, and automotives areas.

We are looking forward to setting up business relationship with you and hope to provide you with the best service and solution. Let us make a better world for our industry!



Contact us

Tel: +86-755-8981 8866 Fax: +86-755-8427 6832

Email & Skype: info@chipsmall.com Web: www.chipsmall.com

Address: A1208, Overseas Decoration Building, #122 Zhenhua RD., Futian, Shenzhen, China



Alle Rechte vorbehalten/ All rights reserved

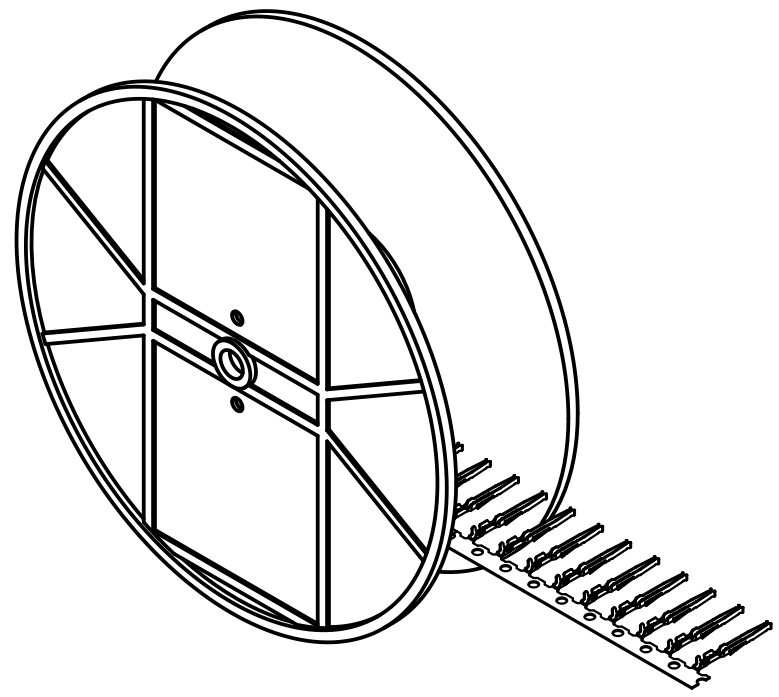
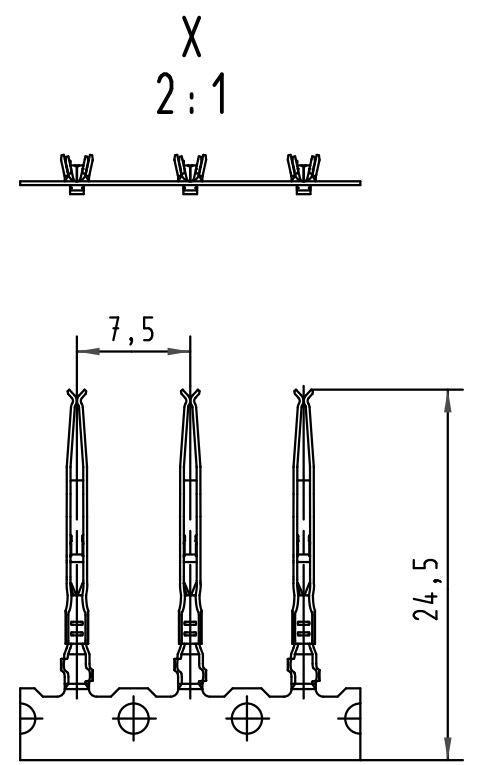
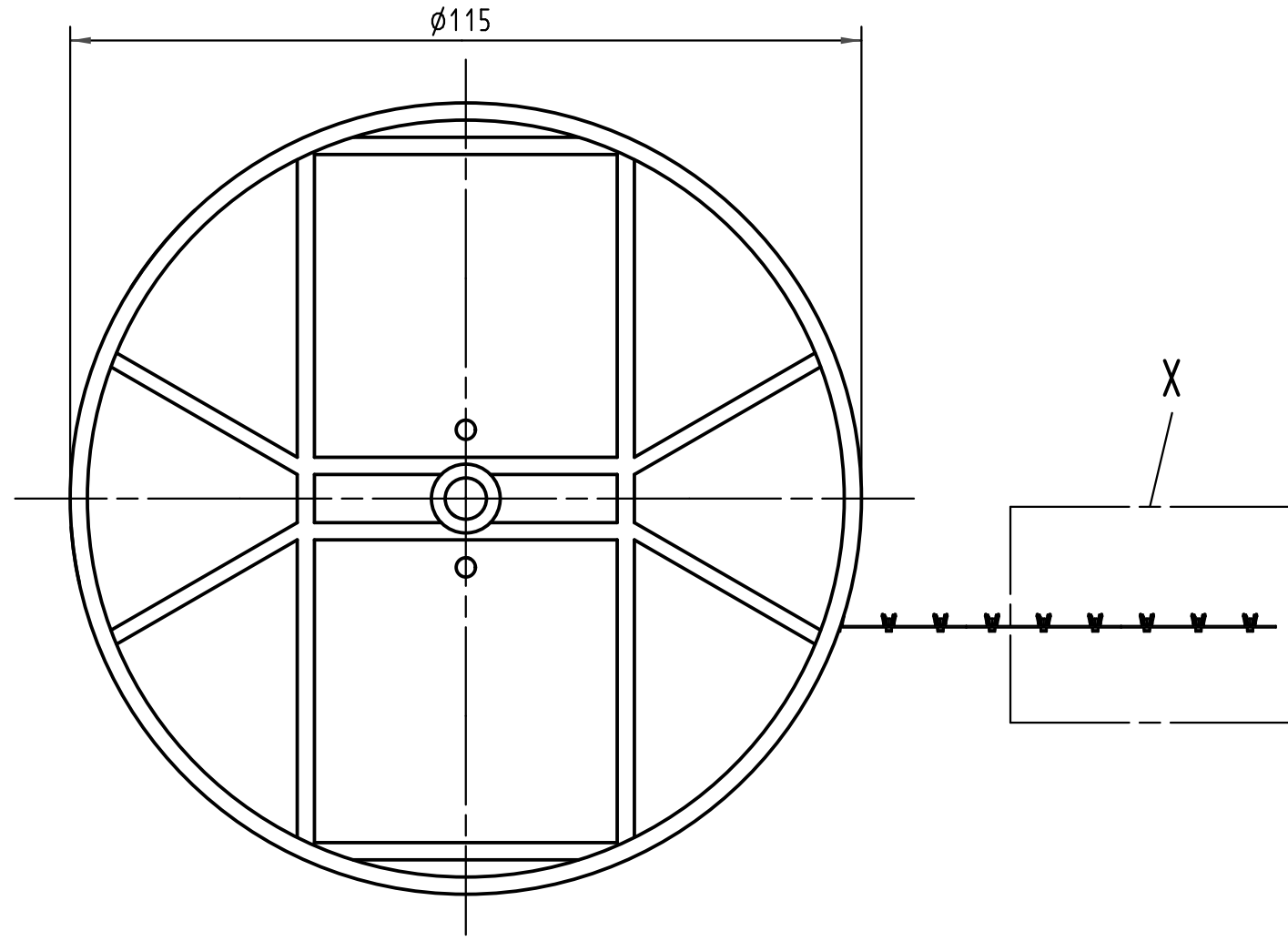
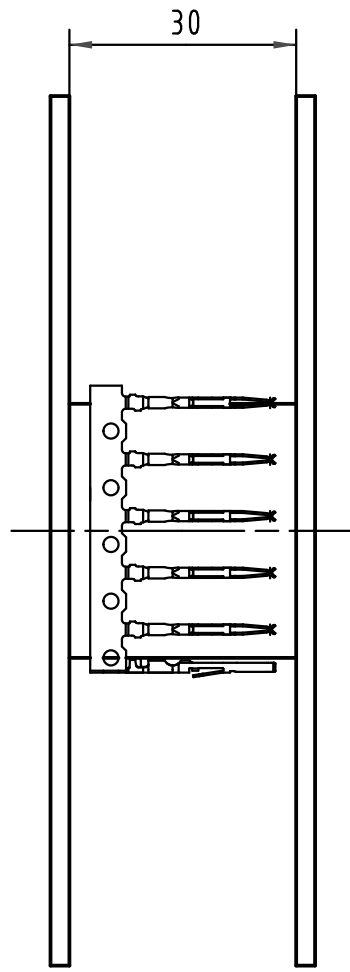

All Dimensions in mm Original Size DIN A 3			Techn. Character.			Nicht tolerierte Maß/Free size tolerances		
				Dat.	Name	Maßstab/Scale 1:1 (2:1)	<i>B-C Crimp-contact 500 pcs. per reel</i> <i>Performance level 1 acc.to DIN EN 60603-2</i> <i>AWG 28-20 (0,09-0,5mm²)</i>	
			Detail.	01.06.99	Hl.			
			Insp.	01.06.99	Be.			
35187	06.06.08	LehT	Stand.					
34650	24.10.07	Hage.						
26050								
Mod.	Dat.	Name	HARTING Electronics GmbH & Co. KG D-32339 ESPELKAMP					TB 09 02 000 8444
							Sub.	Blatt/ page