



Chipsmall Limited consists of a professional team with an average of over 10 year of expertise in the distribution of electronic components. Based in Hongkong, we have already established firm and mutual-benefit business relationships with customers from,Europe,America and south Asia,supplying obsolete and hard-to-find components to meet their specific needs.

With the principle of “Quality Parts,Customers Priority,Honest Operation,and Considerate Service”,our business mainly focus on the distribution of electronic components. Line cards we deal with include Microchip,ALPS,ROHM,Xilinx,Pulse,ON,Everlight and Freescale. Main products comprise IC,Modules,Potentiometer,IC Socket,Relay,Connector.Our parts cover such applications as commercial,industrial, and automotives areas.

We are looking forward to setting up business relationship with you and hope to provide you with the best service and solution. Let us make a better world for our industry!



Contact us

Tel: +86-755-8981 8866 Fax: +86-755-8427 6832

Email & Skype: info@chipsmall.com Web: www.chipsmall.com

Address: A1208, Overseas Decoration Building, #122 Zhenhua RD., Futian, Shenzhen, China



Alle Rechte vorbehalten/ All rights reserved

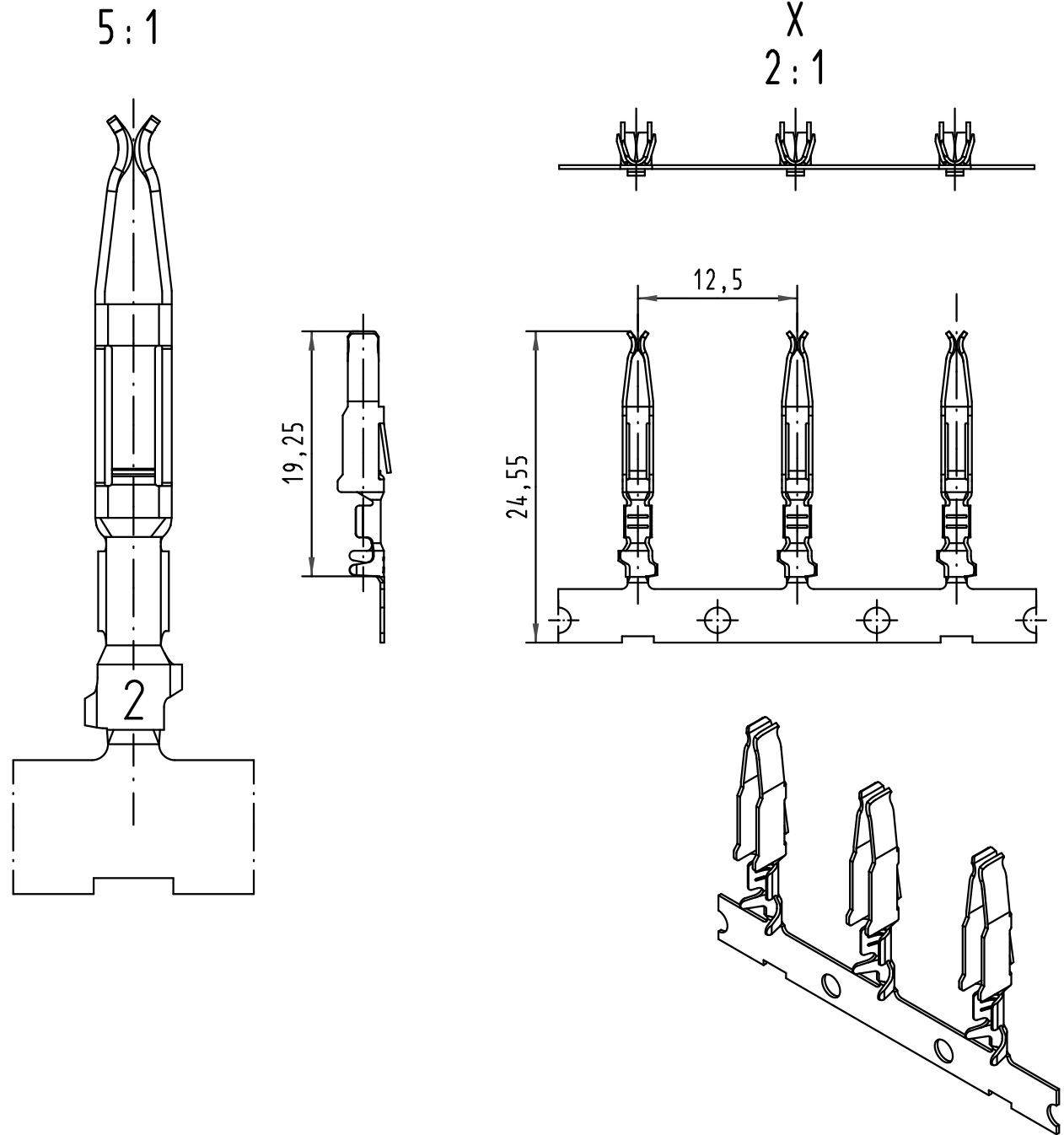
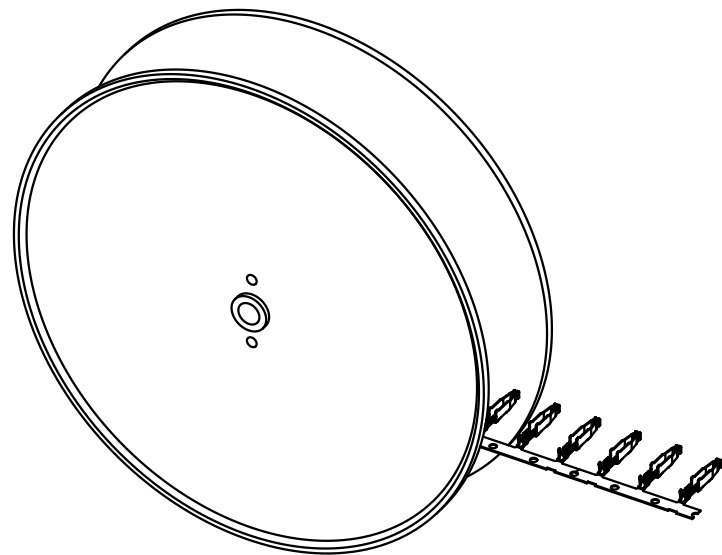
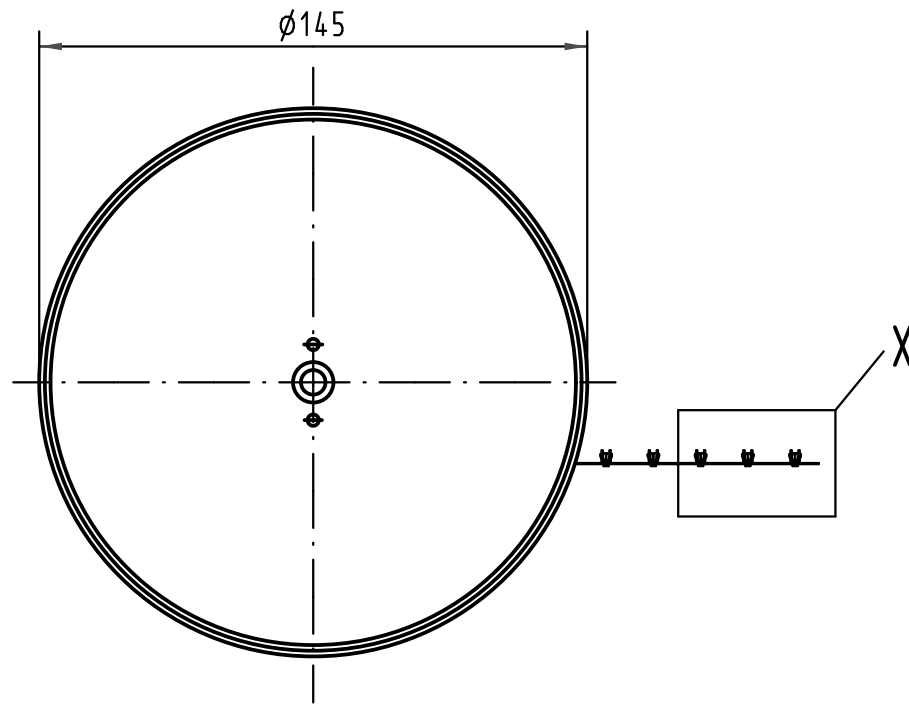
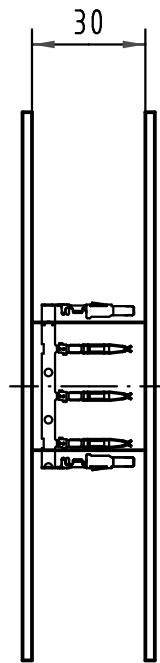

09 06 000 7481	2
09 06 000 7471	1
Bestell-Nr. part-no.	Anforderungsstufe nach IEC performance level acc.to IEC

All Dimensions in mm Original Size DIN A 3			Techn. Character.			Nicht tolerierte Maßel Free size tolerances complementary IEC 60603-2			
						Bauform/type F-C crimp Federkontakt Crimpkontur 2 für 0,14 - 0,56mm ² 250 Kontakte auf Haspel female contact crimp contour 2 for 0,14 - 0,56mm ² 250 contacts on reel			
			Detail.	17.01.06	Leh.				Maßstab/Scale 1:2 2:1; 5:1
			Insp.	17.01.06	Ge.				
			Stand.						
35449	17.11.08	Hage.	HARTING Electronics GmbH & Co. KG				TB 09 06 000 74x1	Blatt/ page	
33227			D-32339 ESPELKAMP						
Mod.	Dat.	Name					Sub.		