



Chipsmall Limited consists of a professional team with an average of over 10 year of expertise in the distribution of electronic components. Based in Hongkong, we have already established firm and mutual-benefit business relationships with customers from,Europe,America and south Asia,supplying obsolete and hard-to-find components to meet their specific needs.

With the principle of “Quality Parts,Customers Priority,Honest Operation,and Considerate Service”,our business mainly focus on the distribution of electronic components. Line cards we deal with include Microchip,ALPS,ROHM,Xilinx,Pulse,ON,Everlight and Freescale. Main products comprise IC,Modules,Potentiometer,IC Socket,Relay,Connector.Our parts cover such applications as commercial,industrial, and automotives areas.

We are looking forward to setting up business relationship with you and hope to provide you with the best service and solution. Let us make a better world for our industry!



Contact us

Tel: +86-755-8981 8866 Fax: +86-755-8427 6832



Email & Skype: info@chipsmall.com Web: www.chipsmall.com

Address: A1208, Overseas Decoration Building, #122 Zhenhua RD., Futian, Shenzhen, China

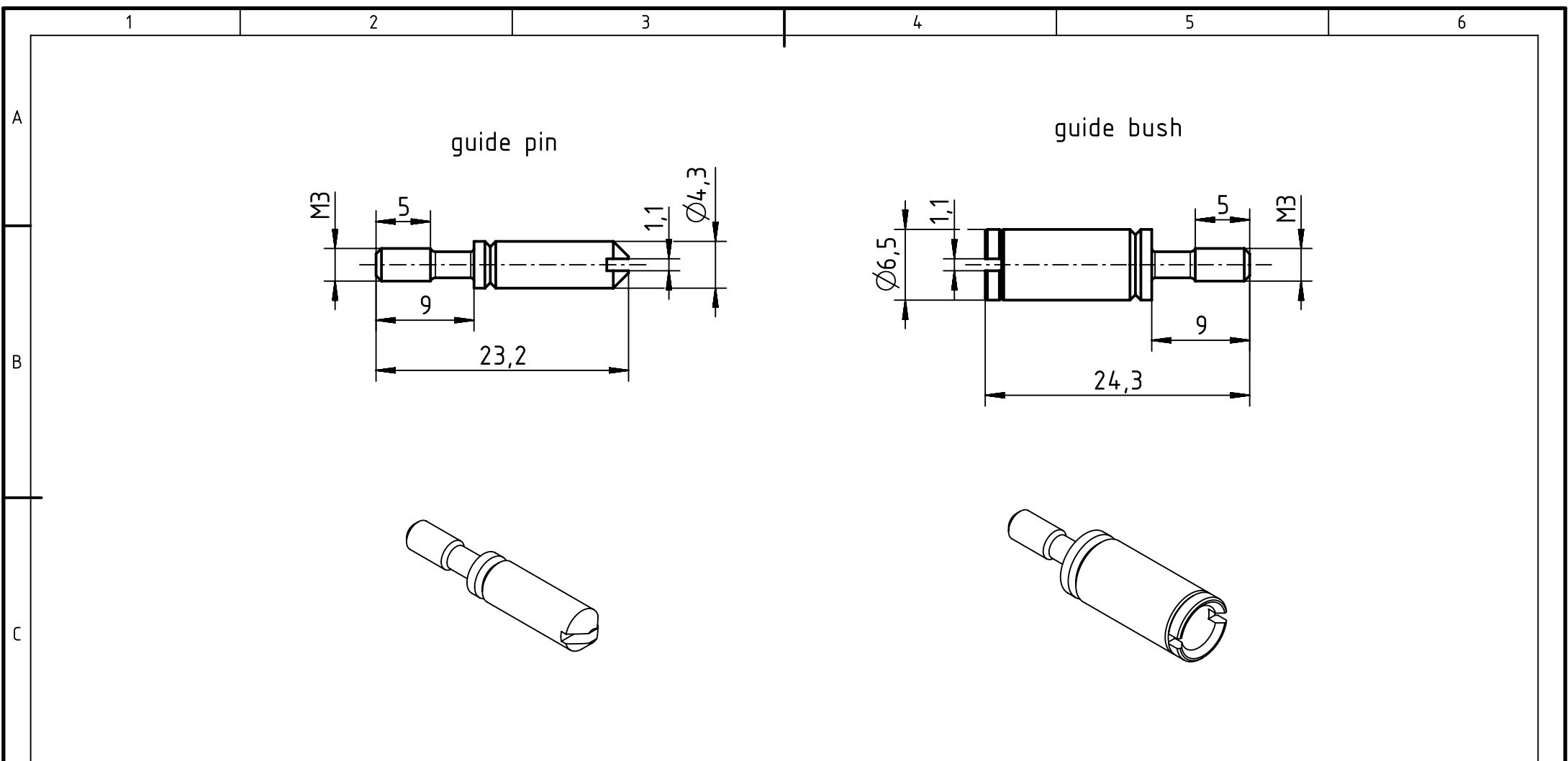

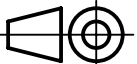

arrangement of pins and bushes see page 2 and 3

	All Dimensions in mm Original Size DIN A4		Scale 2:1	Free size tol.		Ref.	
	 All rights reserved Department EL PD - DE		Created by KLASSEN P	Inspected by BERGHORN	Standardisation TIEMANNA	Sub.	
09 14 000 9909	guide bush	HARTING Electric GmbH & Co. KG D-32339 Espelkamp	Title Han-Modular Fuehrungstifte			Date 2017-01-16	State Final Release
09 14 000 9908	guide pin		Type TB			Doc-Key / ECM-Nr. 100175794/UGD/003/D 500000113697	Rev. D
part number	description		Number 09 14 000 990X			Page 1/3	

1 2 3 4 5 6

coding system with guide pins and bushes

for hoods/housings with one frame or hinged frame

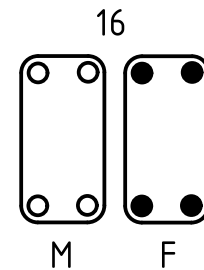
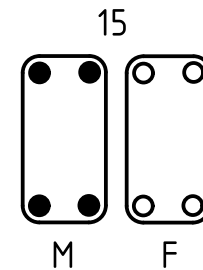
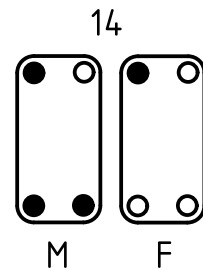
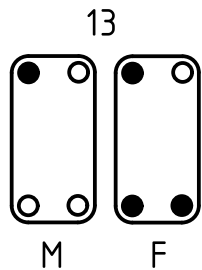
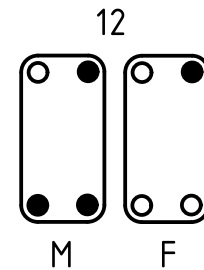
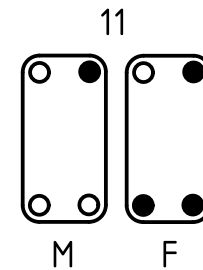
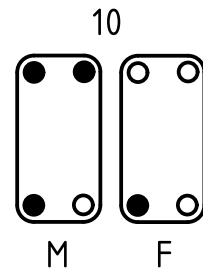
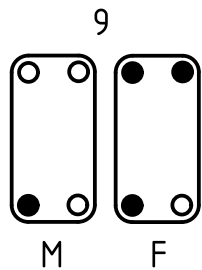
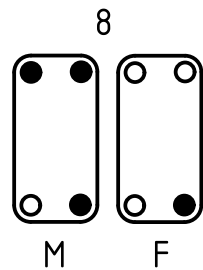
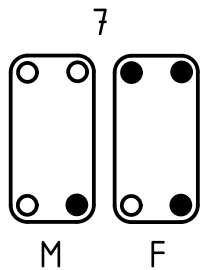
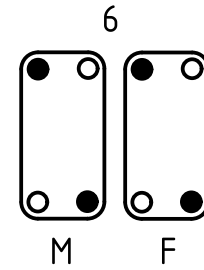
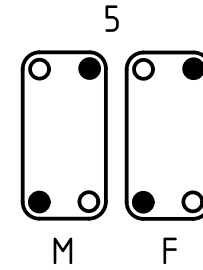
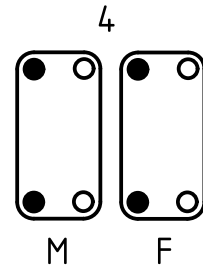
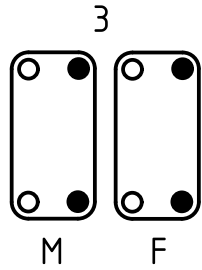
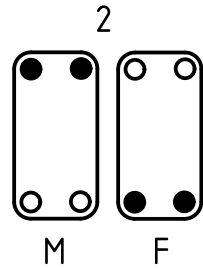
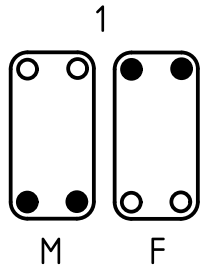

- F - frame or hinged frame for hoods
M - frame or hinged frame for housings
● - guide pin
○ - guide bush

	All rights reserved	Created by KLASSEN P	Inspected by BERGHORN	Standardisation TIEMANNA	Date 2017-01-16	State Final Release	
	Department EL PD - DE	Title Han-Modular Fuehrungsstifte				Doc-Key / ECM-Nr. 100175794/UGD/003/D 500000113697	
HARTING Electric GmbH & Co. KG D-32339 Espelkamp		Type TB	Number 09 14 000 990X			Rev. D	Page 2/3

coding system with code pins

for hoods/housings with two frame or two hinged frame

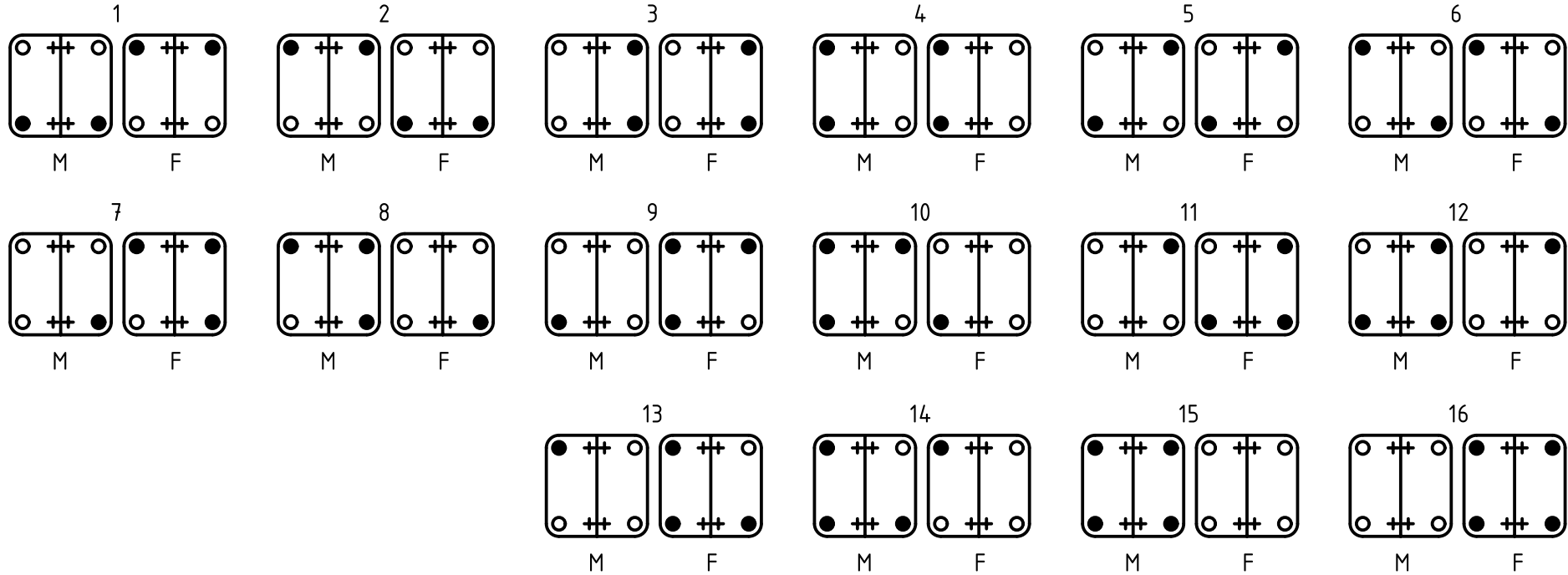

- F - frame or hinged frame for hoods
- M - frame or hinged frame for housings
- - guide pin
- - guide bush
- + - mounting screw

	All rights reserved	Created by	Inspected by	Standardisation	Date	State	
	Department EL PD - DE	KLASSEN P	BERGHORN	TIEMANNA	2017-01-16	Final Release	
HARTING Electric GmbH & Co. KG		Title				Doc-Key / ECM-Nr.	
D-32339 Espelkamp		Han-Modular Fuehrungsstifte				100175794 / UGD / 003 / D 500000113697	
		Type	Number			Rev.	Page
		TB	09 14 000 990X			D	3/3