



Chipsmall Limited consists of a professional team with an average of over 10 year of expertise in the distribution of electronic components. Based in Hongkong, we have already established firm and mutual-benefit business relationships with customers from,Europe,America and south Asia,supplying obsolete and hard-to-find components to meet their specific needs.

With the principle of "Quality Parts,Customers Priority,Honest Operation,and Considerate Service",our business mainly focus on the distribution of electronic components. Line cards we deal with include Microchip,ALPS,ROHM,Xilinx,Pulse,ON,Everlight and Freescale. Main products comprise IC,Modules,Potentiometer,IC Socket,Relay,Connector.Our parts cover such applications as commercial,industrial, and automotives areas.

We are looking forward to setting up business relationship with you and hope to provide you with the best service and solution. Let us make a better world for our industry!



Contact us

Tel: +86-755-8981 8866 Fax: +86-755-8427 6832

Email & Skype: info@chipsmall.com Web: www.chipsmall.com

Address: A1208, Overseas Decoration Building, #122 Zhenhua RD., Futian, Shenzhen, China



5 4 3 2 1

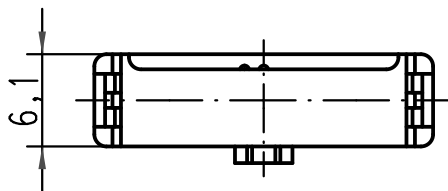
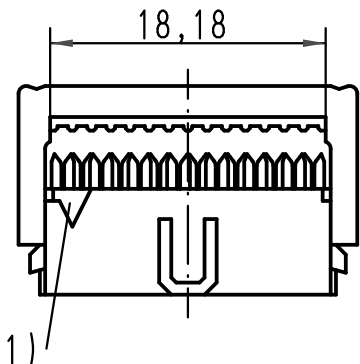
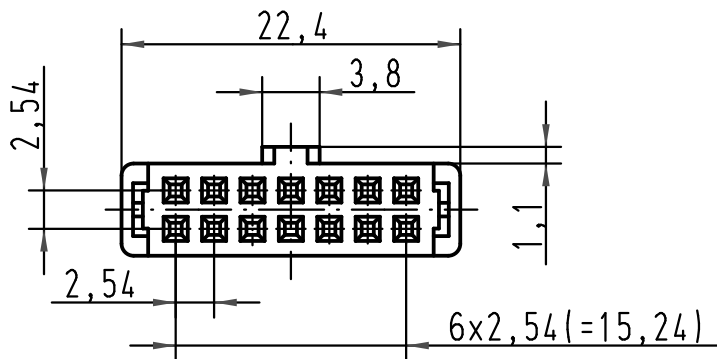

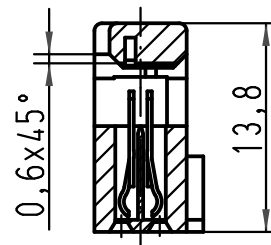

vorverrastet
pre assembled
preassemble

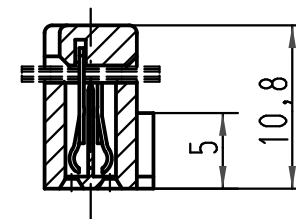

verrastet
fitted
assemble



1) Markierung erster Kontakt, Ader 1 des Flachkabels
1) Contact no.1, 1st contact wire of flat cable
1) Contact no.1, repère 1 du câble

A	0918 514 5803 58U	0,76 μm Au	Bulk packaging MOQ = 5000 pcs	 All Dimensions in mm Original Size DIN A 4			Techn. Character.			Nicht tolerierte Masse! Free size tolerances			
	0918 514 6803 58U	2											
	0918 514 7803 58U	3											
	0918 514 5803	0,76 μm Au	N.A.				Detail.	01-FEB-00	Name	Massstab/Scale 2:1	SEK 18 Female Connector 14 poles with central polarisation cover without cable stop		
	0918 514 6803	2	N.A.				Insp.		Th				
	0918 514 7803	3	N.A.	33797	10/08/06	PK	Stand.						
	Bestell-Nr. Part-No. Reference	Anforderungsstufe Performance level Niveau de qualite	Index Designation	33788	24/07/06	PK	HARTING EURL F-95972 Paris				TB 09 18 514 X803	Blatt/ page 1/1	
				26570	01-FEB-00	JB							
				Mod.	Dat.	Name							