



Chipsmall Limited consists of a professional team with an average of over 10 year of expertise in the distribution of electronic components. Based in Hongkong, we have already established firm and mutual-benefit business relationships with customers from,Europe,America and south Asia,supplying obsolete and hard-to-find components to meet their specific needs.

With the principle of “Quality Parts,Customers Priority,Honest Operation,and Considerate Service”,our business mainly focus on the distribution of electronic components. Line cards we deal with include Microchip,ALPS,ROHM,Xilinx,Pulse,ON,Everlight and Freescale. Main products comprise IC,Modules,Potentiometer,IC Socket,Relay,Connector.Our parts cover such applications as commercial,industrial, and automotives areas.

We are looking forward to setting up business relationship with you and hope to provide you with the best service and solution. Let us make a better world for our industry!



Contact us

Tel: +86-755-8981 8866 Fax: +86-755-8427 6832

Email & Skype: info@chipsmall.com Web: www.chipsmall.com

Address: A1208, Overseas Decoration Building, #122 Zhenhua RD., Futian, Shenzhen, China



Alle Rechte vorbehalten/ All rights reserved

**Y
(Lochbild)
(board drillings)**

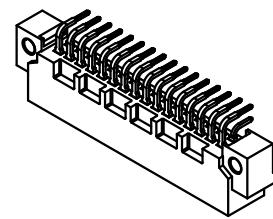
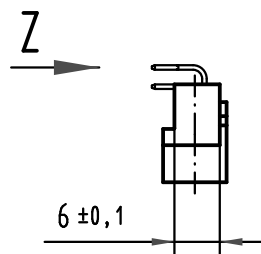
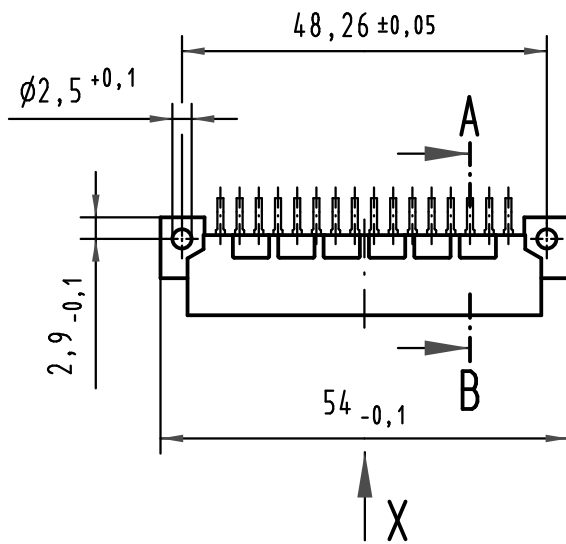
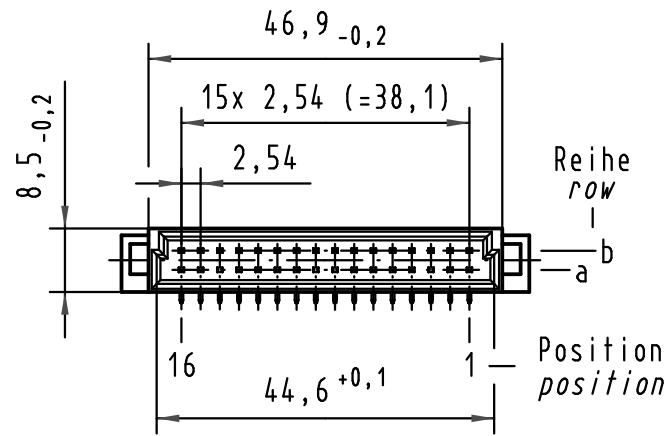
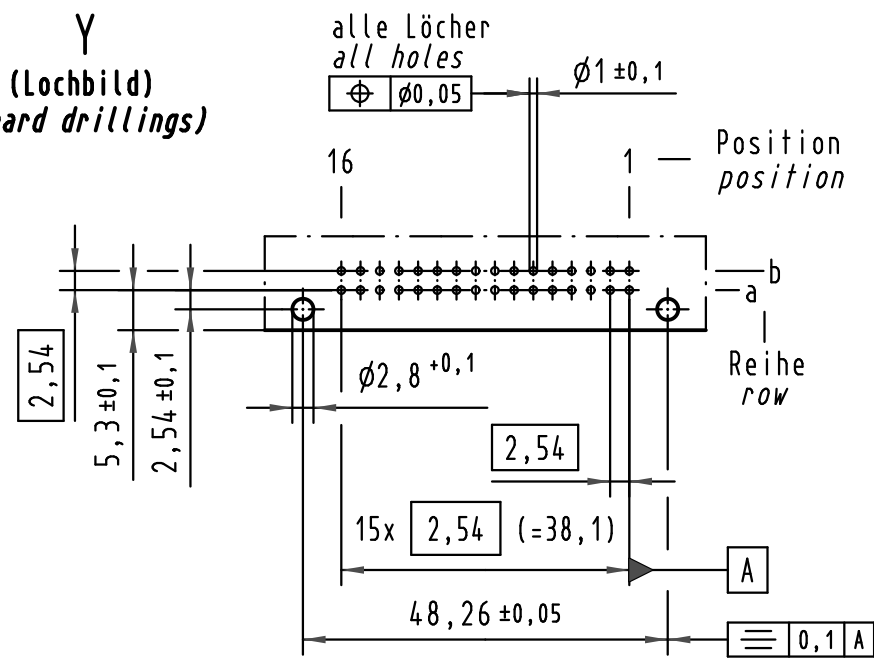

A-B
2:1

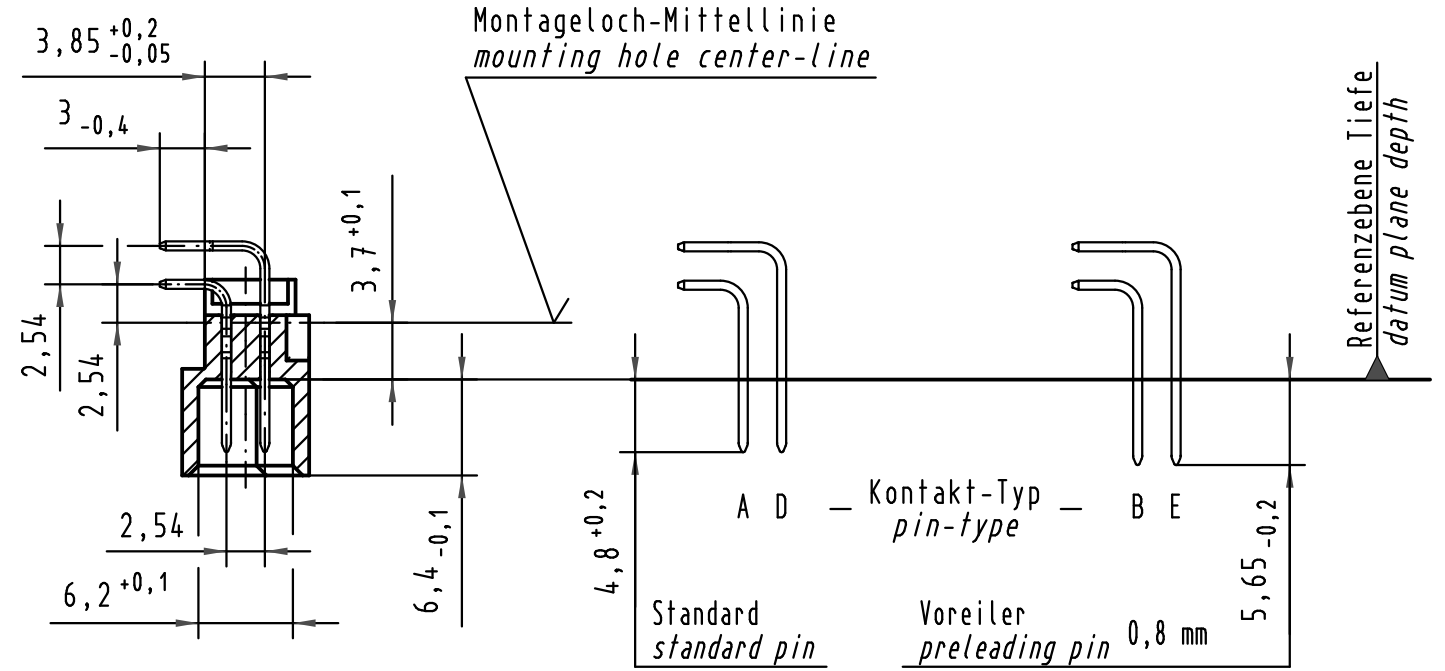

**X Kontaktbelegung
contact loading**

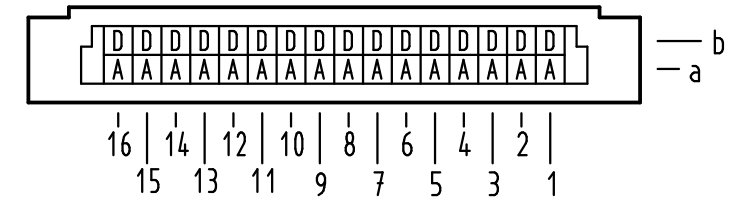

09 22 132 6919	2	Au flash over PdNi over Ni
Bestell-Nr. part-no.	Anforderungsstufe nach IEC performance level acc. to IEC	Kontaktoberfläche contact plating

Z
10:1

Querschnitt der
Lötanschlüsse:
cross-section of
solder terminations:

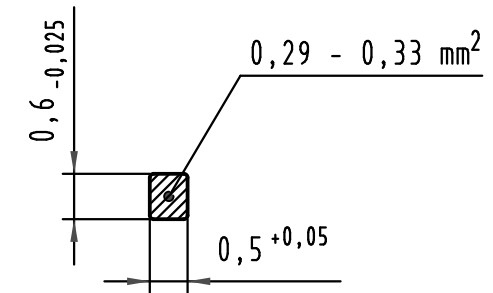

 All Dimensions in mm Original Size DIN A 3	Techn. Character.			Nicht tolerierte Maße/Free size tolerances IEC 60603-2		
		Dat.	Name	Maßstab/Scale	Bauform 2B Messerleiste Einlötl, 32 pol., SMC (Hochtemperatur) type 2B male connector solder, 32 pol., SMC (high temperature)	
		Detail.	28.08.09 Bus.			1:1
		Insp.	28.08.09 TD			2:1
	Stand.		10:1			
35568	HARTING Electronics GmbH & Co. KG			 TB 09 22 132 x919	Blatt/ page	
Mod.	Dat.	Name	D-32339 ESPELKAMP			Sub.