



Chipsmall Limited consists of a professional team with an average of over 10 year of expertise in the distribution of electronic components. Based in Hongkong, we have already established firm and mutual-benefit business relationships with customers from,Europe,America and south Asia,supplying obsolete and hard-to-find components to meet their specific needs.

With the principle of “Quality Parts,Customers Priority,Honest Operation,and Considerate Service”,our business mainly focus on the distribution of electronic components. Line cards we deal with include Microchip,ALPS,ROHM,Xilinx,Pulse,ON,Everlight and Freescale. Main products comprise IC,Modules,Potentiometer,IC Socket,Relay,Connector.Our parts cover such applications as commercial,industrial, and automotives areas.

We are looking forward to setting up business relationship with you and hope to provide you with the best service and solution. Let us make a better world for our industry!



Contact us

Tel: +86-755-8981 8866 Fax: +86-755-8427 6832

Email & Skype: info@chipsmall.com Web: www.chipsmall.com

Address: A1208, Overseas Decoration Building, #122 Zhenhua RD., Futian, Shenzhen, China





SIDE HINGE (10 mm)

Version 1

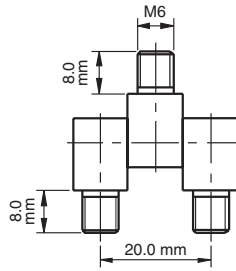
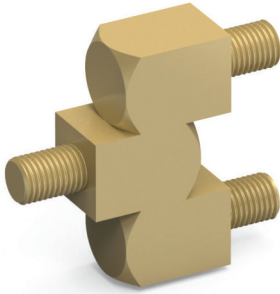

Hinge Rotation Angle

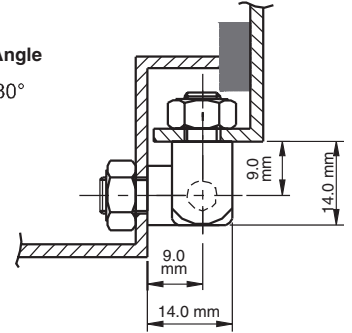
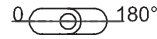

Specifications
• Material: Brass

Features
• Side-mounted hinge
• Brass 10 mm parts supplied separately.
For different dimensions contact Essentra

SIDE HINGE (12 mm)

Version 2

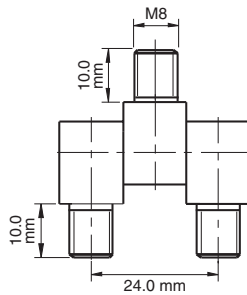
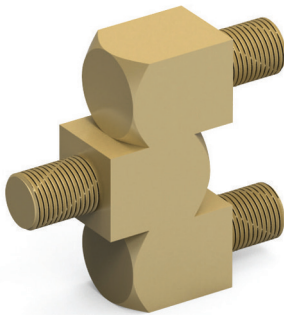

Hinge Rotation Angle

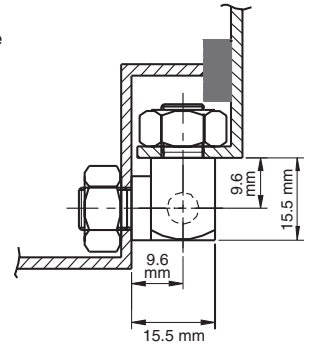

Specifications
• Material: Brass

Features
• Side-mounted hinge
• Three 12 mm brass parts supplied separately.
For different dimensions contact Essentra.

SIDE HINGE (12 mm)

Version 3

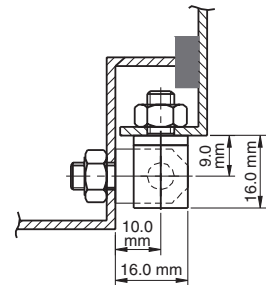
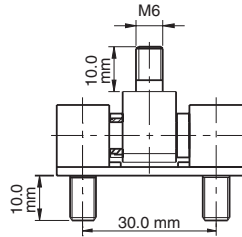
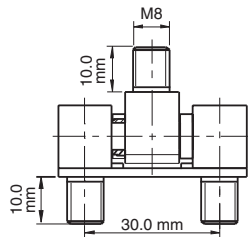
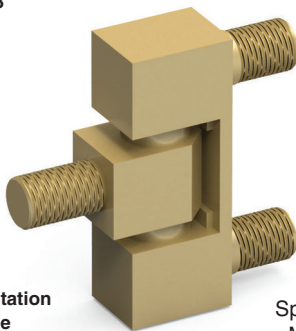

Hinge Rotation Angle

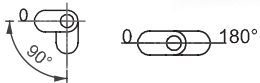

Specifications
• Material: Brass

Features
• Side-mounted hinge
• Three 12 mm brass parts supplied separately.
For different dimensions contact Essentra.
• 90° and 180° angle versions are available

Item Number	Hinge Rotation	Material	Finish	Thread	Version
09030	180°	Brass	Brass	M6	1
09034	180°	Brass	Nickel	M6	1
09130	180°	Brass	Brass	M8	2
09131	180°	Brass	Nickel	M8	2
092306180	180°	Brass	Brass	M6	3
09230690	90°	Brass	Brass	M6	3

Item Number	Hinge Rotation	Material	Finish	Thread	Version
092308180	180°	Brass	Brass	M8	3
09230890	90°	Brass	Brass	M8	3
092316180	180°	Brass	Chrome	M6	3
09231690	90°	Brass	Chrome	M6	3
092318180	180°	Brass	Chrome	M8	3
09231890	90°	Brass	Chrome	M8	3