



Chipsmall Limited consists of a professional team with an average of over 10 year of expertise in the distribution of electronic components. Based in Hongkong, we have already established firm and mutual-benefit business relationships with customers from,Europe,America and south Asia,supplying obsolete and hard-to-find components to meet their specific needs.

With the principle of “Quality Parts,Customers Priority,Honest Operation,and Considerate Service”,our business mainly focus on the distribution of electronic components. Line cards we deal with include Microchip,ALPS,ROHM,Xilinx,Pulse,ON,Everlight and Freescale. Main products comprise IC,Modules,Potentiometer,IC Socket,Relay,Connector.Our parts cover such applications as commercial,industrial, and automotives areas.

We are looking forward to setting up business relationship with you and hope to provide you with the best service and solution. Let us make a better world for our industry!



## Contact us

Tel: +86-755-8981 8866 Fax: +86-755-8427 6832



Email & Skype: info@chipsmall.com Web: www.chipsmall.com

Address: A1208, Overseas Decoration Building, #122 Zhenhua RD., Futian, Shenzhen, China

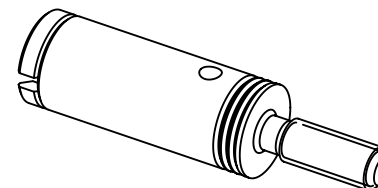
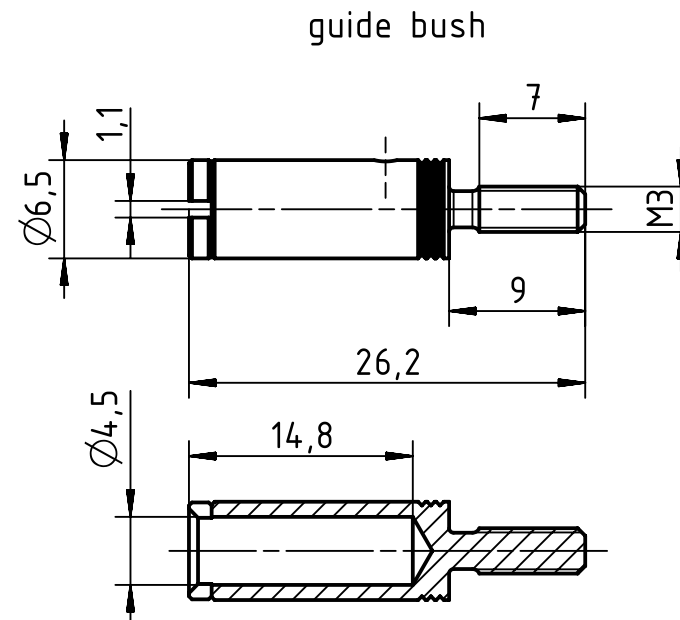
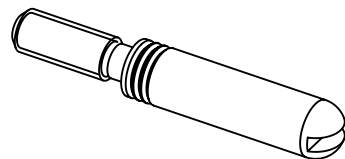
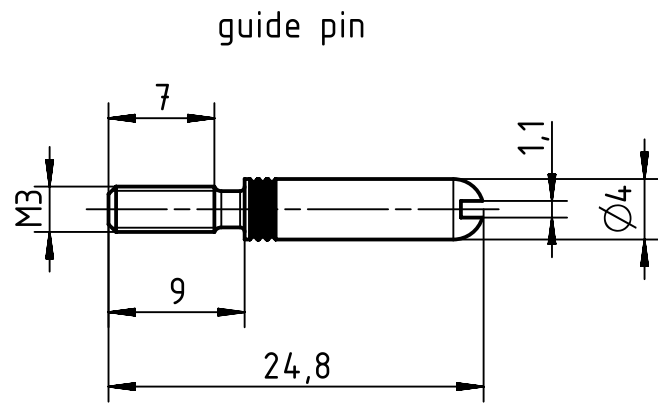

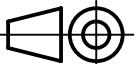

arrangement of pins and bushes see page 2 and 3

 All Dimensions in mm Original Size DIN A4		Scale 2:1	Free size tol.		Ref.
 All rights reserved Department EL PD - DE		Created by HELLMANN	Inspected by RIEPE	Standardisation RUETERA	Date 2018-01-11
HARTING Electric GmbH & Co. KG D-32339 Espelkamp		Title guide bush/pin			State Final Release
09 33 000 9809	guide bush	Type TB			Doc-Key / ECM-Nr. 100208457/UGD/003/C 500000129848
09 33 000 9808	guide pin	Number 09 33 000 980X			Rev. C
Part No	description				Page 1/3

1 2 3 4 5 6

# coding system with guide pins and bushes

for hoods/housings with one frame or hinged frame

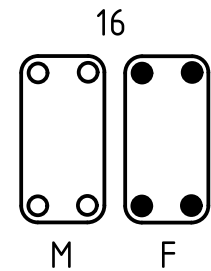
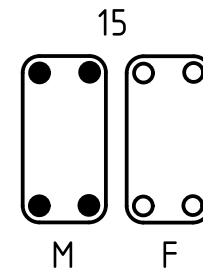
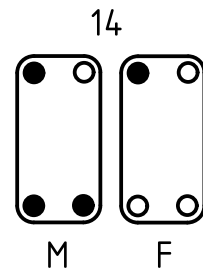
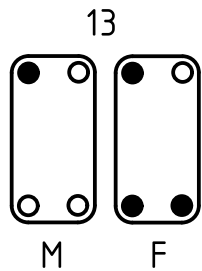
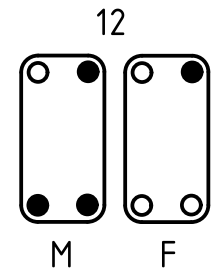
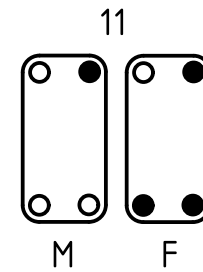
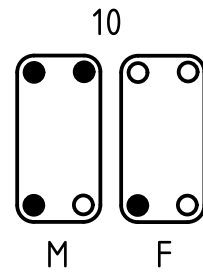
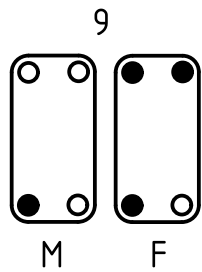
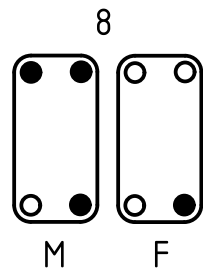
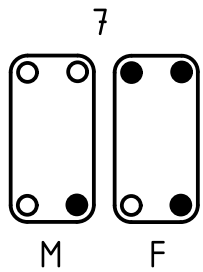
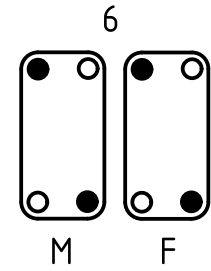
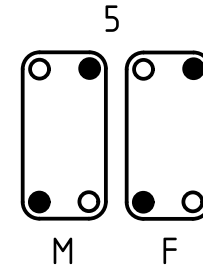
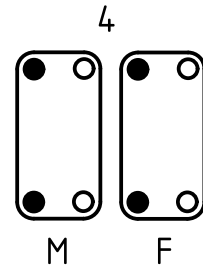
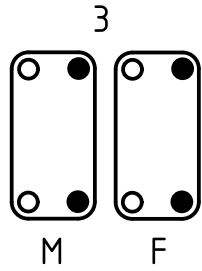
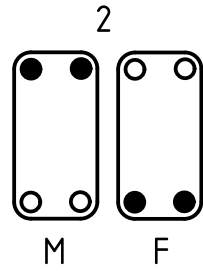
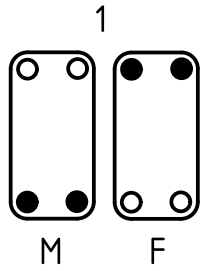

- F - frame or hinged frame for hoods
- M - frame or hinged frame for housings
- - guide pin
- - guide bush

	All rights reserved	Created by HELLMANN	Inspected by RIEPE	Standardisation RUETERA	Date 2018-01-11	State Final Release	
	Department EL PD - DE	Title guide bush/pin				Doc-Key / ECM-Nr. 100208457/UGD/003/C 500000129848	
HARTING Electric GmbH & Co. KG D-32339 Espelkamp		Type TB	Number 09 33 000 980X			Rev. C	Page 2/3

# coding system with code pins

for hoods/housings with two frame or two hinged frame

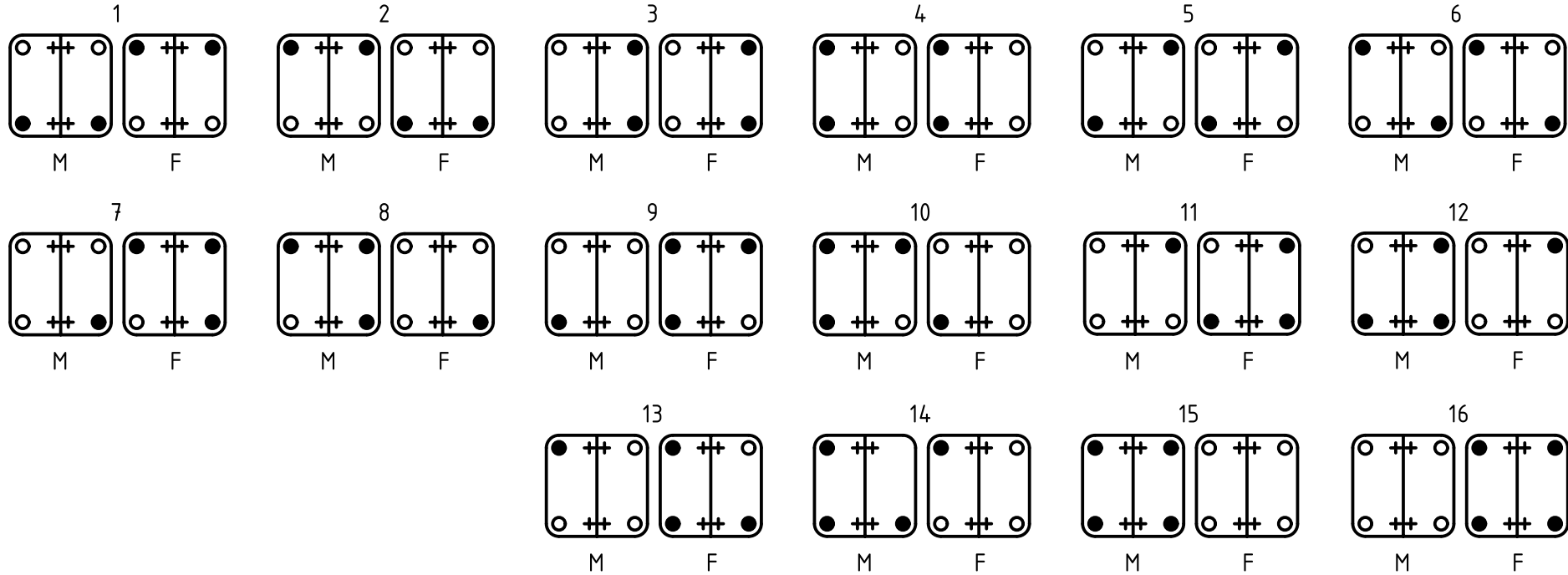

- F - frame or hinged frame for hoods
- M - frame or hinged frame for housings
- - guide pin
- - guide bush
- + - mounting screw

	All rights reserved	Created by HELLMANN	Inspected by RIEPE	Standardisation RUETERA	Date 2018-01-11	State Final Release	
	Department EL PD - DE	Title guide bush/pin				Doc-Key / ECM-Nr. 100208457/UGD/003/C 500000129848	
HARTING Electric GmbH & Co. KG D-32339 Espelkamp		Type TB	Number 09 33 000 980X			Rev. C	Page 3/3