



Chipsmall Limited consists of a professional team with an average of over 10 year of expertise in the distribution of electronic components. Based in Hongkong, we have already established firm and mutual-benefit business relationships with customers from,Europe,America and south Asia,supplying obsolete and hard-to-find components to meet their specific needs.

With the principle of “Quality Parts,Customers Priority,Honest Operation,and Considerate Service”,our business mainly focus on the distribution of electronic components. Line cards we deal with include Microchip,ALPS,ROHM,Xilinx,Pulse,ON,Everlight and Freescale. Main products comprise IC,Modules,Potentiometer,IC Socket,Relay,Connector.Our parts cover such applications as commercial,industrial, and automotives areas.

We are looking forward to setting up business relationship with you and hope to provide you with the best service and solution. Let us make a better world for our industry!



Contact us

Tel: +86-755-8981 8866 Fax: +86-755-8427 6832

Email & Skype: info@chipsmall.com Web: www.chipsmall.com

Address: A1208, Overseas Decoration Building, #122 Zhenhua RD., Futian, Shenzhen, China



5

4



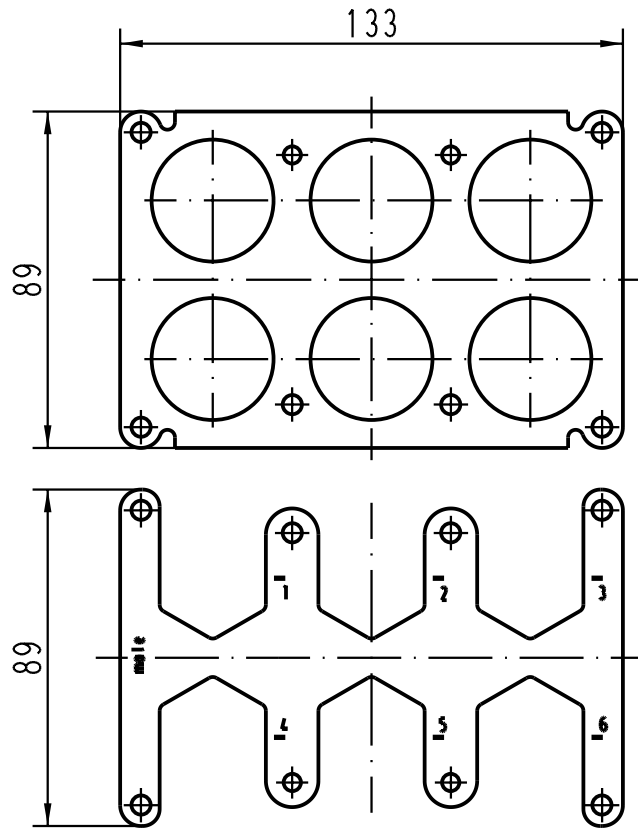

3

2

1



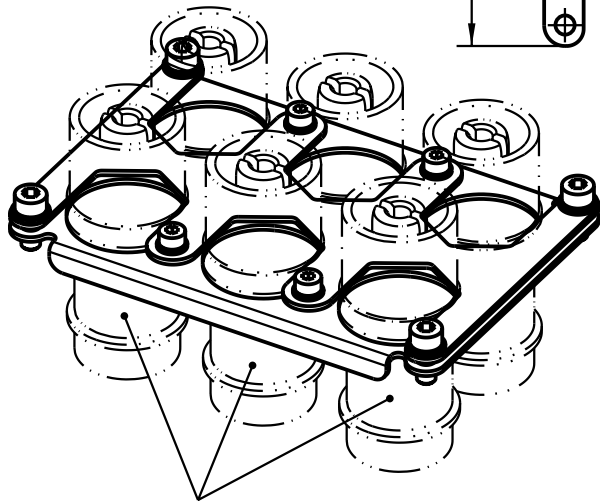

lose mitgeliefert:/
separately enclosed:

-  4x Sechskantmutter M4/
4x nut M4
-  8x Sperrkantscheibe SK S4/
8x washer M4
-  4x Zylinderschraube M4x10 (SW3)/
4x fillister head cap screw M4x10 (SW3)
-  4x Sperrkantscheibe SK S5/
4x washer M5
-  4x Zylinderschraube M5x12 (SW4)/
4x fillister head cup screw M5x12 (SW4)

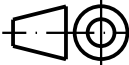

nicht im Lieferumfang enthalten/
not range of delivery

 All Dimensions in mm Original Size DIN A 4	Techn. Character.			Nicht tolerierte Masse/ Free size tolerances	
		Dat.	Name	Massstab/Scale	
	Detail.	11.03.04	Loe.	1:2	
	Insp.		KR		
	Stand.				
410926	HARTING Electric GmbH & Co. KG			TB 09 40 048 9806	
Mod.	Dat.	Name	D-32339 Espelkamp		
					Blatt/ page
			Sub.		