



Chipsmall Limited consists of a professional team with an average of over 10 year of expertise in the distribution of electronic components. Based in Hongkong, we have already established firm and mutual-benefit business relationships with customers from,Europe,America and south Asia,supplying obsolete and hard-to-find components to meet their specific needs.

With the principle of "Quality Parts,Customers Priority,Honest Operation,and Considerate Service",our business mainly focus on the distribution of electronic components. Line cards we deal with include Microchip,ALPS,ROHM,Xilinx,Pulse,ON,Everlight and Freescale. Main products comprise IC,Modules,Potentiometer,IC Socket,Relay,Connector.Our parts cover such applications as commercial,industrial, and automotives areas.

We are looking forward to setting up business relationship with you and hope to provide you with the best service and solution. Let us make a better world for our industry!



Contact us

Tel: +86-755-8981 8866 Fax: +86-755-8427 6832

Email & Skype: info@chipsmall.com Web: www.chipsmall.com

Address: A1208, Overseas Decoration Building, #122 Zhenhua RD., Futian, Shenzhen, China



5

4

3

2

1

D



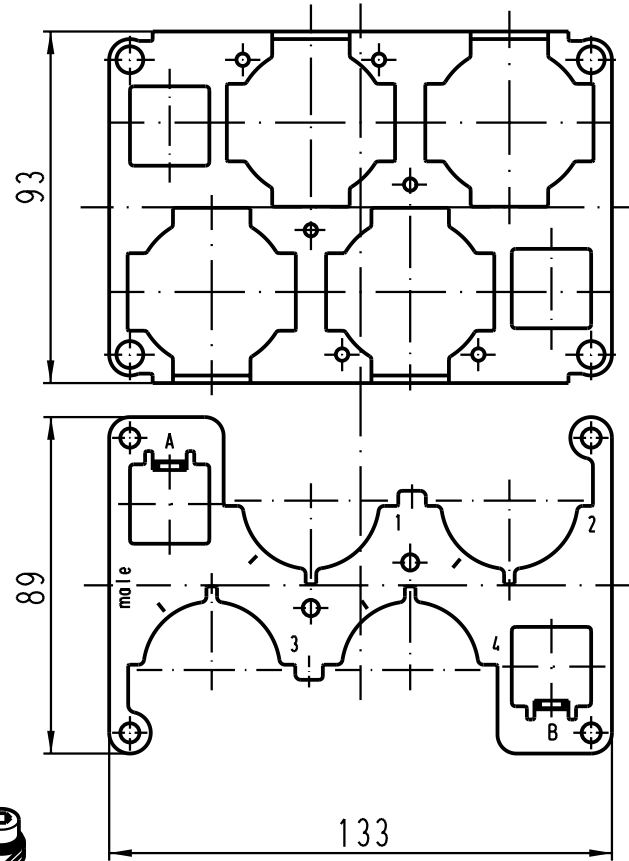

C

B

A



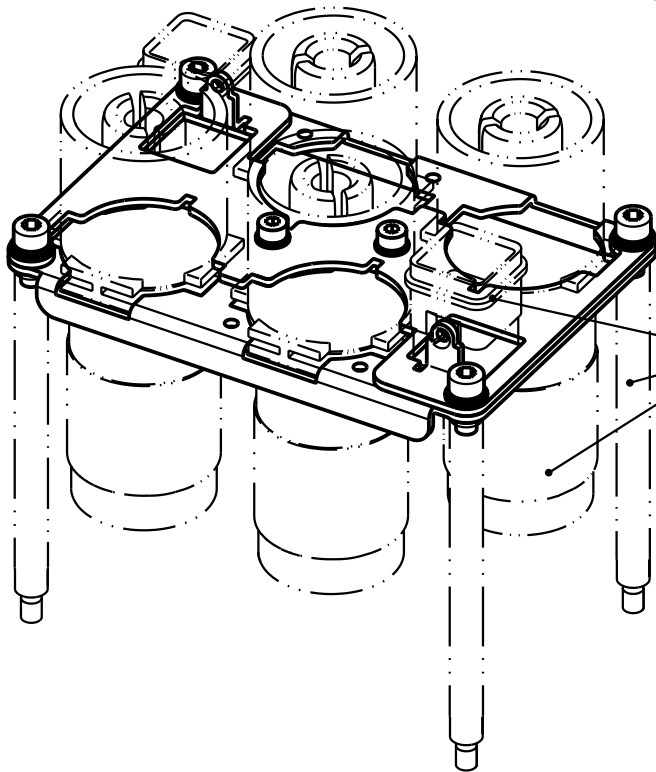

Lose mitgeliefert:/
separately enclosed:

-  4 x Zylinderschraube M5x12/
4 x fillister head cap screw M5x12
-  4 x Sperrkantscheibe SK S5/
4 x washer M5
-  2 x Zylinderschraube M4x10/
2 x fillister head cap screw M4x10
-  2 x Sperrkantscheibe SK S4/
2 x washer M4

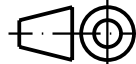

nicht im Lieferumfang enthalten/
not range of delivery

 All Dimensions in mm Original Size DIN A 4		Techn. Character.			Nicht tolerierte Masse/ Free size tolerances	
			Dat.	Name	Massstab/Scale 1:2	Halterung Han 4HC Stift 4 x 650A Frame Han 4HC male 4 x 650A Han 48HPR
		Detail.	27.03.03	Ho		
		Insp.		Ole		
		Stand.				
410968	20.04.04	Loe.	HARTING Electric GmbH & Co. KG			TB 09 40 048 9811
410435			D-32339 Espelkamp			
Mod.	Dat.	Name				
					Sub.	Blatt/ page