



Chipsmall Limited consists of a professional team with an average of over 10 year of expertise in the distribution of electronic components. Based in Hongkong, we have already established firm and mutual-benefit business relationships with customers from,Europe,America and south Asia,supplying obsolete and hard-to-find components to meet their specific needs.

With the principle of “Quality Parts,Customers Priority,Honest Operation,and Considerate Service”,our business mainly focus on the distribution of electronic components. Line cards we deal with include Microchip,ALPS,ROHM,Xilinx,Pulse,ON,Everlight and Freescale. Main products comprise IC,Modules,Potentiometer,IC Socket,Relay,Connector.Our parts cover such applications as commercial,industrial, and automotives areas.

We are looking forward to setting up business relationship with you and hope to provide you with the best service and solution. Let us make a better world for our industry!



## Contact us

Tel: +86-755-8981 8866 Fax: +86-755-8427 6832

Email & Skype: info@chipsmall.com Web: www.chipsmall.com

Address: A1208, Overseas Decoration Building, #122 Zhenhua RD., Futian, Shenzhen, China



# CODING KEY TOOL

Quantity: 1

# CODING KEY STARS

Quantity: 10

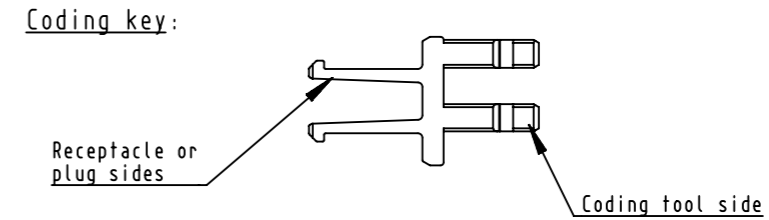
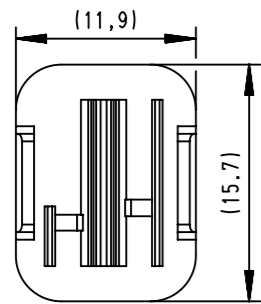
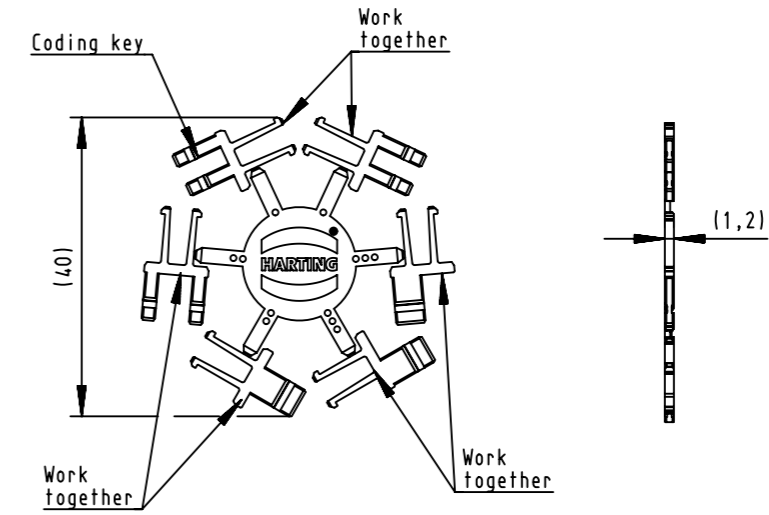
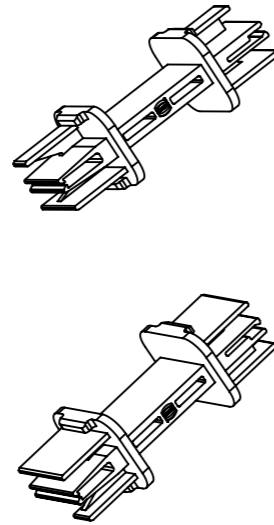
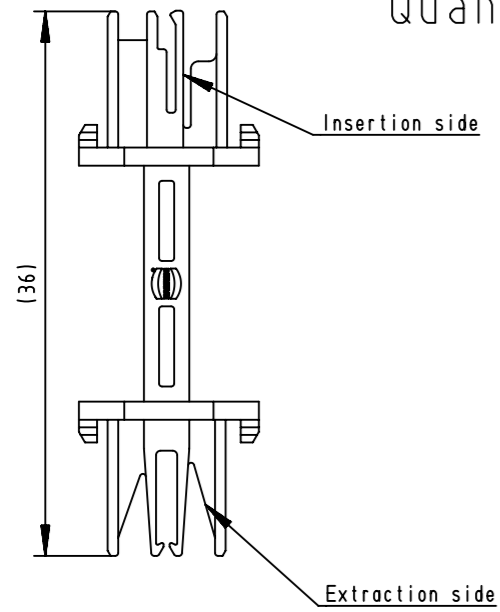

## KEYING ON CODING KEY TOOL

Keying area: V shape of receptacle or plug shell MUST be on this coding key tool side

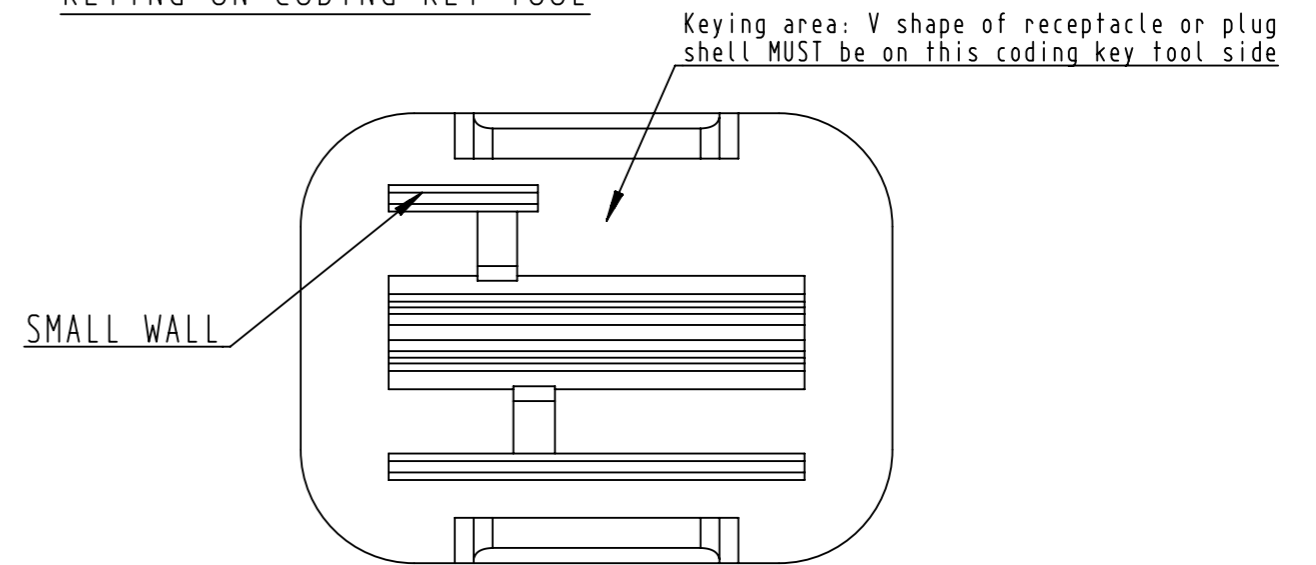

RECEPTACLE

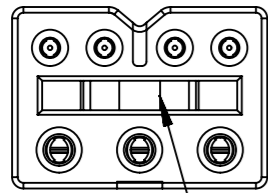

Areas for coding key

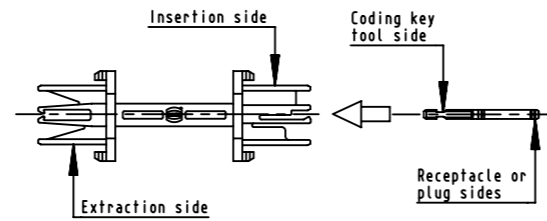
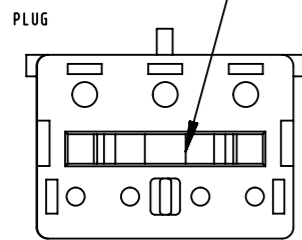

For coding key insertion: coding key is inserted in tool insertion side  
 For coding key extraction: coding key is inserted in tool extraction side  
 Coding key is locked inside counterpart after hearing CLICK sound

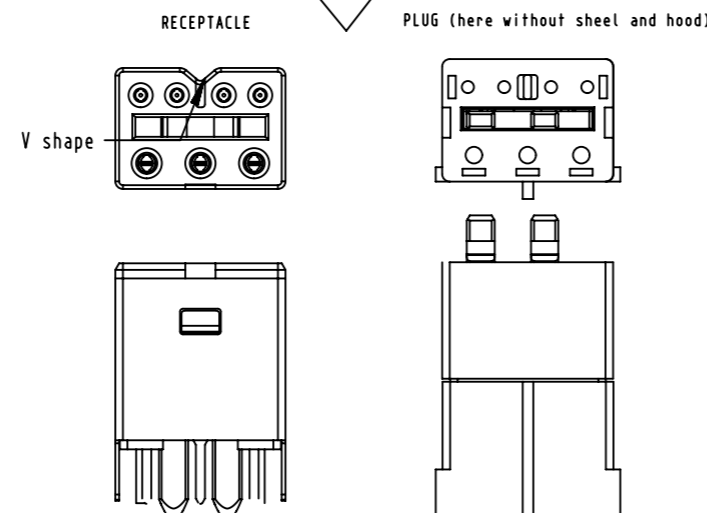

Coating	A=	mm <sup>2</sup>	V=	mm <sup>2</sup>	m=	g	Mat.
	All Dimensions in mm Original Size DIN A3		Scale 1:1	Free size tol.		Ref. Sub.	
	All rights reserved Department EC PD - FR		Created by BARLEMONT	Inspected by DE VANSAY	Standardisation HOFFMANN	Date 2013-02-08	State Final Release
HARTING Electronics GmbH D-32339 Espelkamp			Title HPP V4 Hybrid coding key set			Doc-Key / ECH-Nr. 100178556/UGD/001/C	
			Type TB	Number 09458451300		Rev. C	Page 1/1