



Chipsmall Limited consists of a professional team with an average of over 10 year of expertise in the distribution of electronic components. Based in Hongkong, we have already established firm and mutual-benefit business relationships with customers from,Europe,America and south Asia,supplying obsolete and hard-to-find components to meet their specific needs.

With the principle of "Quality Parts,Customers Priority,Honest Operation,and Considerate Service",our business mainly focus on the distribution of electronic components. Line cards we deal with include Microchip,ALPS,ROHM,Xilinx,Pulse,ON,Everlight and Freescale. Main products comprise IC,Modules,Potentiometer,IC Socket,Relay,Connector.Our parts cover such applications as commercial,industrial, and automotives areas.

We are looking forward to setting up business relationship with you and hope to provide you with the best service and solution. Let us make a better world for our industry!



## Contact us

Tel: +86-755-8981 8866 Fax: +86-755-8427 6832

Email & Skype: info@chipsmall.com Web: www.chipsmall.com

Address: A1208, Overseas Decoration Building, #122 Zhenhua RD., Futian, Shenzhen, China





98 42 115 0201



Pushing Performance

# HARTING Automation IT

Industrial Cabling ISO/IEC 24 702 / EN 50 173-3



People | Power | Partnership



**HARTING**

The HARTING Technology Group based in Espelkamp, East Westphalia, Germany, develops tailored electrical and electronic connector solutions and products for power distribution and data communications applications. The company also supplies a range of networking products. Harting was founded in 1945 and currently has around 2,600 employees worldwide. The vital importance of networking in bringing together customers, suppliers and technology and business partners continues to increase in today's knowledge and information driven societies. This holds true for the domestic markets and even more so on the global stage. With subsidiaries in 25 countries, HARTING ensures the essential close proximity to its customers and markets. Local presence gives HARTING direct access to the dynamics of key markets and the capability to respond flexibly and rapidly according to specific requirements.

The HARTING brand stands for outstanding quality and reliability worldwide. The exceptionally high standard of performance is based on an uncompromising quality management system, which is certified and audited on a regular basis to standards such as EN ISO 9001, the EU eco audit and ISO 14001:2004.

[www.HARTING.com](http://www.HARTING.com)

**LEONI Kerpen**

LEONI Kerpen is one of the leading players in the cable industry. The company has been successfully meeting the complex needs of the international cable markets for over 85 years. LEONI currently employs a workforce of more than 700 members of staff. The commitment to continuous further development and evolution is one of LEONI Kerpen's core values. Firmly rooted in its rich tradition, the company has its sights set firmly on the future. LEONI has the vision to develop innovative, high-quality cables and cabling products which are always one step ahead of the current standards. Based on our extensive expertise in the development and production of cables and cabling systems, we serve the needs of customers at the high-end of the IT and industrial markets. LEONI Kerpen delivers future-proof passive system solutions based on copper and optical fiber technologies.

Backed by a highly motivated, creative and professional workforce, LEONI Kerpen maintains a presence through its subsidiaries and sales offices in all of the world's major markets. Quality is and will remain the benchmark at LEONI Kerpen, and this commitment to quality was verified for the first time when our quality management system was certified to DIN EN ISO 9001 in 1990. The LEONI Kerpen environmental management system has been certified since 1998 (DIN ISO 14001).

[www.leoni-kerpen.com](http://www.leoni-kerpen.com)



**Automation IT**

Automation IT stands for the strategic focus on a communications platform which supports all applications in the corporate-wide business context. It replaces all previous proprietary and bounded communication systems.

Long-term success depends on a company's ability to give customers what they need in a consistent process which extends from order placement, production and delivery all the way through to after-sales service and support. Quality, cost and above all speed are the success factors that ensure future growth.

Structured, application-neutral cabling has now been standardized worldwide. The ISO/IEC 11801 and EN 50173 standards define data transmission characteristics, as well as planning, implementation and operational requirements. ISO/IEC 24702 and EN 50173-3 make the benefits of generic cabling available to industrial users around the world.

HARTING and LEONI Kerpen have bundled their connector and cabling expertise to create a harmonized cabling system, giving investors and planners a cost-effective instrument for developing advanced corporate communications solutions.

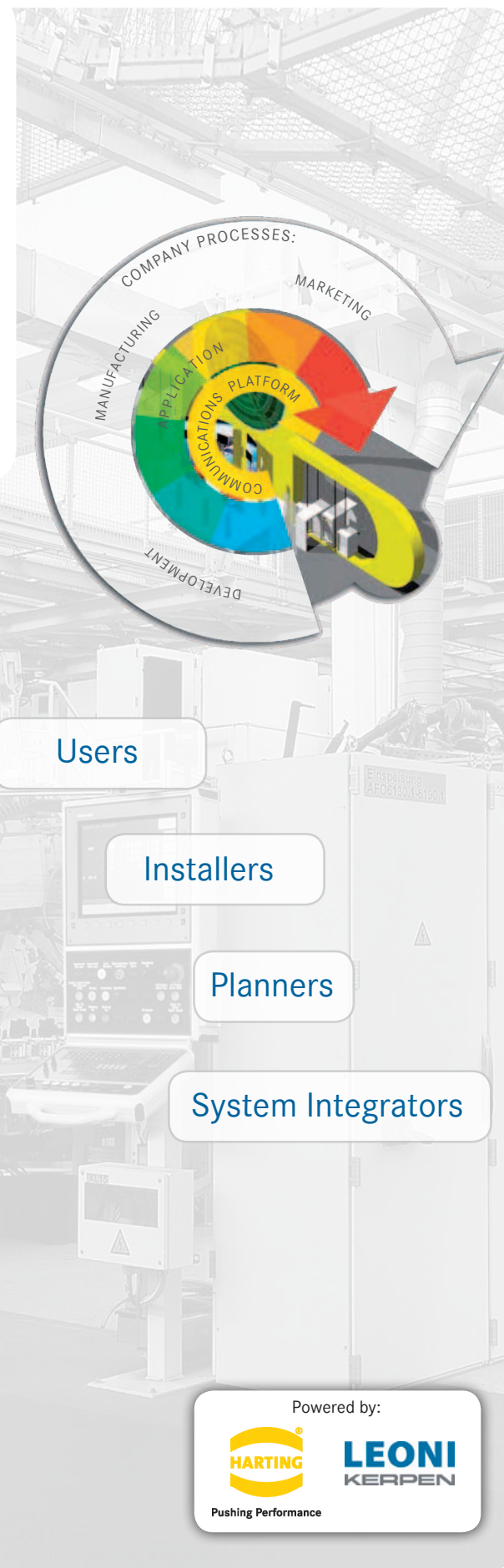



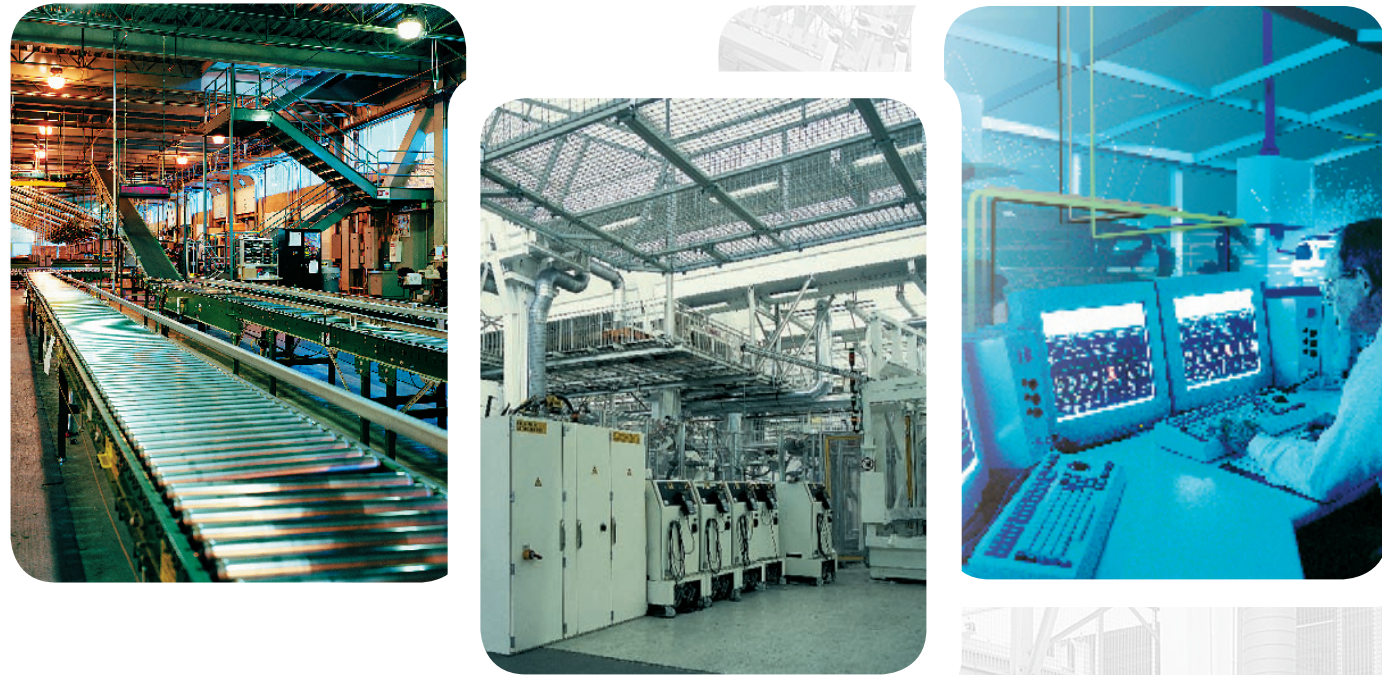

FOR ALL TYPES OF INDUSTRIES

HARTING and LEONI Kerpen offer universal cabling solutions serving the needs of all types of industries, while also enabling solutions tailored to specific needs.

ISO/IEC 11801  
EN 50173-1:  
Information Technology –  
Generic cabling systems –  
General requirements

ISO/IEC 11801  
EN 50173-2:  
Information Technology –  
Generic cabling systems –  
Office premises

ISO/IEC 24702  
EN 50173-3:  
Information Technology –  
Generic cabling systems –  
Industrial premises

ISO/IEC 15018  
EN 50173-4:  
Information Technology –  
Generic cabling systems –  
Homes

ISO/IEC 24764  
EN 50173-5:  
Information Technology –  
Generic cabling systems –  
Data centers

GENERIC CABLING

Compliant cabling from HARTING and LEONI-Kerpen supports current and future migration strategies and is absolutely application neutral. The modular cabling solution delivers performance users need for today's Fast Ethernet and 1 Gbit systems and for tomorrow's 10 Gbit Ethernet.

TAILORED TO THE OPERATING ENVIRONMENT

Our cabling system components provide the right level of protection on the production floor, in the shop or outdoors in any operating environment.

MECHANICAL STRESS

SHOCK AND VIBRATION

MOISTURE AND DUST

CONDUCTIVE CONTAMINATION

TEMPERATURE FLUCTUATIONS

CHEMICAL ATTACK

AGGRESSIVE ATMOSPHERES

WEATHERING AND UV RADIATION

EMC INTERFERENCE

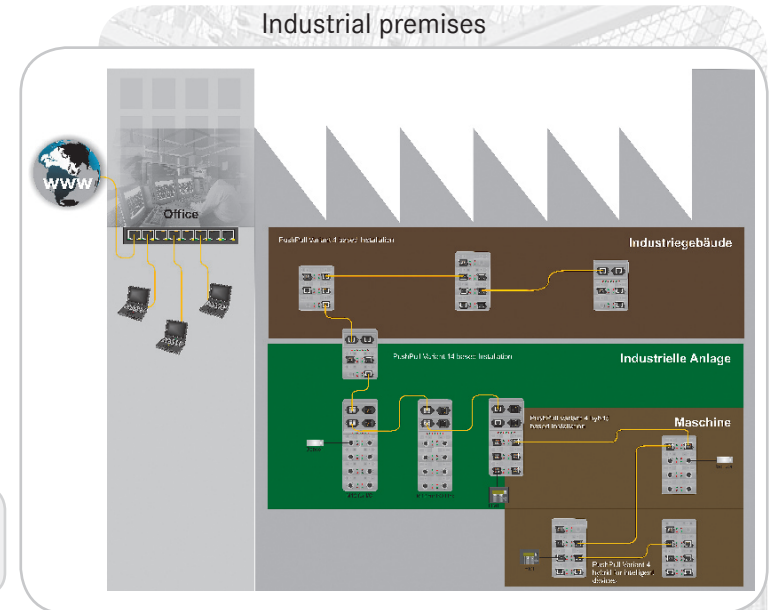



### The ISO/IEC 24702 industrial environment

#### Environmental classification

Industrial cabling has to function in a very broad spectrum of environments, ranging from semiconductor production in a cleanroom to extreme contamination in close proximity to a blast furnace. The MICE classification systems has been developed and documented in ISO/IEC 24702 to help users make the right choices for their particular circumstances

The acronym MICE refers to environmental factors which affect the cabling:

- M: Mechanical
- I: Ingress
- C: Climatic, Chemical
- E: Electromagnetic

MICE classifications are broken down into three levels.

M<sub>2</sub>I<sub>3</sub>C<sub>2</sub>E<sub>3</sub> example:

Operating environment for a drive in a production system.

- M<sub>2</sub>: shock 100m/s<sup>2</sup>, vibration displacement amplitude 7,0mm/ 20m/s<sup>2</sup>
- I<sub>3</sub>: IP 65/IP 67, particulate ingress 50µm, splash water and water jet protection
- C<sub>2</sub>: -25°C to +70°C, humidity 5% to 95% (condensing), oil concentration <0,005
- E<sub>3</sub>: radiated RF-AM 3V/m (80-1000MHz) acc. IEC 61000-2-5

MICE gives engineers a method for classifying the operating environment during the planning phase to ensure that they select the right cabling for the application. MICE differentiates between the various conditions at the place of use, and it covers the entire spectrum of production and office environments.

Components designed for the operating environment:

ISO/IEC 24702 defines cabling components that are fit for industrial environments. These components are designed for harsh conditions to complement the components which are intended for office use. Compatibility between IT and automation systems is a prime consideration. The PushPull connector is one example of an industrial component. ISO/IEC 24702 is based on standard office RJ45 and LC duplex connectors, and the components also have to provide good IP protection. The experts selected the HARTING PushPull, which is a fully-fledged industrial connector. RJ45 for twisted pair cable and LC duplex for optical fiber have been defined as the standard inserts. The HARTING PushPull (IEC 61076-3-106 Variant 4) is the only internationally standardized connector for generic industrial premises cabling, and it is the smallest IP 67 connector for RJ45 and LC duplex applications. There are also other industrial cabling components including cables and system cords.

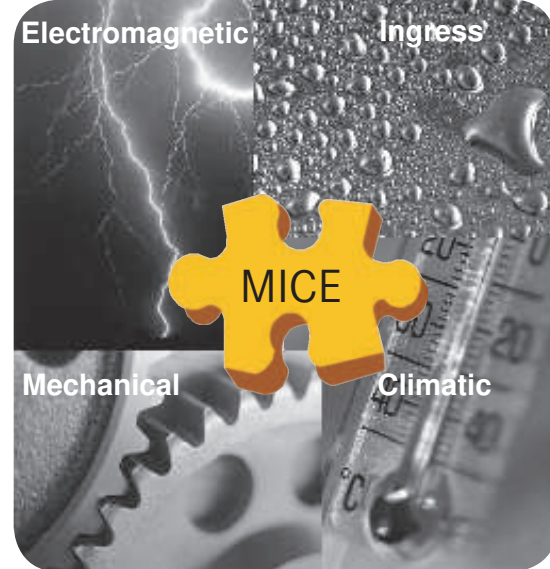

The ISO/IEC 24702 Connectors:



### ISO/IEC 24702 – cabling for industrial environments:

#### Industrial topology

The standardization of industrial cabling is derived from international cabling standard ISO/IEC 11801 to ensure seamless communication over compatible cabling.

This approach has a number of advantages for users:

- Common network component and cabling technology
- Common resource utilization and uniform network management
- One network support team can deliver holistic support, reducing downtime and operating costs

As is the case with ISO/IEC 11801, star topology was selected as the primary industrial topology. The Intermediate Distributor (ID) has been added to the cabling topology for extended industrial applications.

The Intermediate Distributor routes data through the outlet (TO or IO) to the automation island. Industrial PCs, controllers and entire production cells can be attached to the telecommunications outlet (TO), which is also known as the industrial outlet (IO).

#### Channels for industrial applications

Channels that are designed for industrial applications play a major role at the ID level, because the variety of options available supports all of the familiar field bus cabling systems. The spectrum of channel types ranges from a single connectorless channel and direct device-to-device links to complex channels with wall feed-throughs and outlets. ISO/IEC 24702 defines industrial cabling right up to an automation island or apparatus, and cabling between automation islands can also be based on the standard. ISO/IEC 24702 creates the vital link between the IT and automation worlds, making it a cornerstone of Automation IT.

#### The installation strategy:

The application range of the HARTING PushPull connector series is not limited to industrial cabling, for example in the industrial outlet. In conjunction with bulkhead-mounted housings for device data and power applications along with various connectors, system cords and patch cords, the PushPull is also used for machine and system cabling. Simple integration, fast installation and reliable connection are the outstanding features of PushPull technology.

The ISO/IEC 24702 Cabling structure

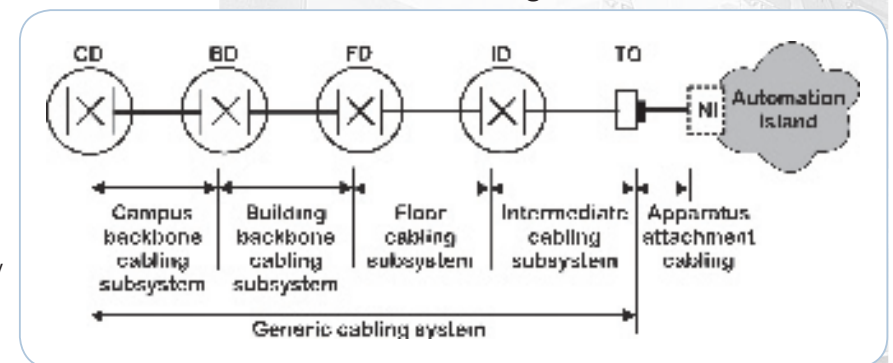

The ISO/IEC 24702 Channel structure

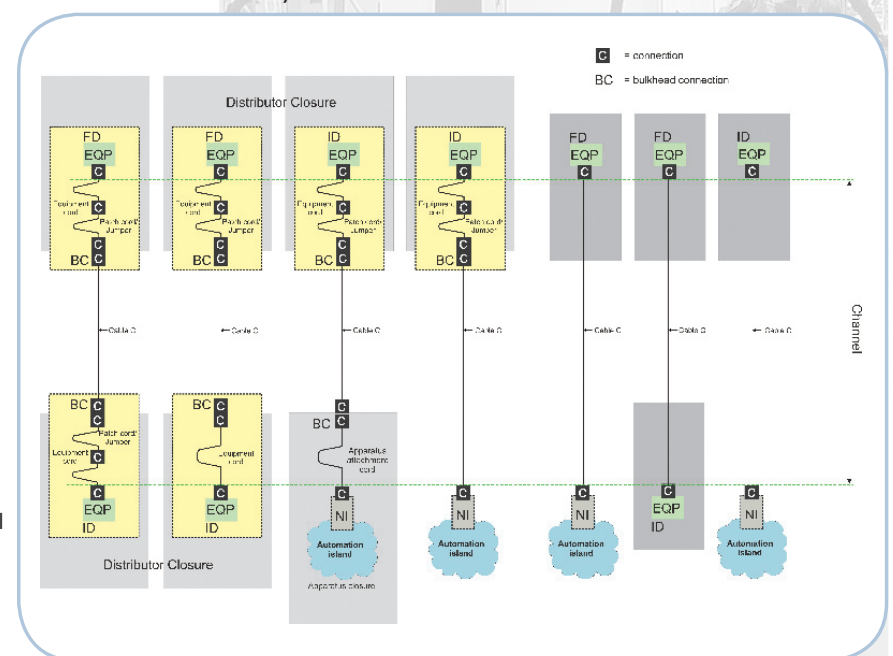





## HARTING PushPull - the IP 67 installation revolution

PushPull connectors offer the following basic advantages:

- Ease of operation
- Reliable, vibration-proof connection with IP 65/67 protection
- Always the same installation procedure

The new PushPull locking mechanism eliminates the need for a retaining clip. Only minimal force is required to insert the connector with one hand until an audible click is heard. The process for removing the connector during a service call is just as simple.

## HARTING PushPull - (IEC 61076-3-106 Variant 4)

### The international standard

Copper, optical fiber and power in one design

This extremely compact product family packs IP 65/IP 67 protection into minimal space. RJ45 (copper)

and LC duplex (optical fiber) versions are available for data communications. There are also a 4-pin 48V/12A module and a 3-pin 250V/16A module to deliver power to field bus devices in distributed architecture applications.

PushPull Variant 4 as defined in IEC 61076-3-106 is the only internationally standardized connector for industrial cabling. It is also the smallest IP 67 connector for RJ45 and optical LC duplex installations.



## Variokeystone® - Revolutionary connectivity technology

LEONI Kerpen's Variokeystone® system offers maximum investment protection. These high-grade components exceed Class E cabling standards. The modular design supports conversion of the mating face from RJ 45 to Tera with minimal effort. There is no need to install new data outlets, making the choice of connectivity technology significantly easier and keeping the door open to tomorrow's higher bit rates. This solution can also accommodate new mating faces that may appear on the market in the future.

Variokeystone® also offers the unique capability to extend or alter a link, which is particularly useful for cabling that is only designed to last for a few years, for example in the automotive industry. The link extender can be used to connect or lengthen cable assemblies with virtually zero transmission loss.

Variokeystone® technology is forward compatible

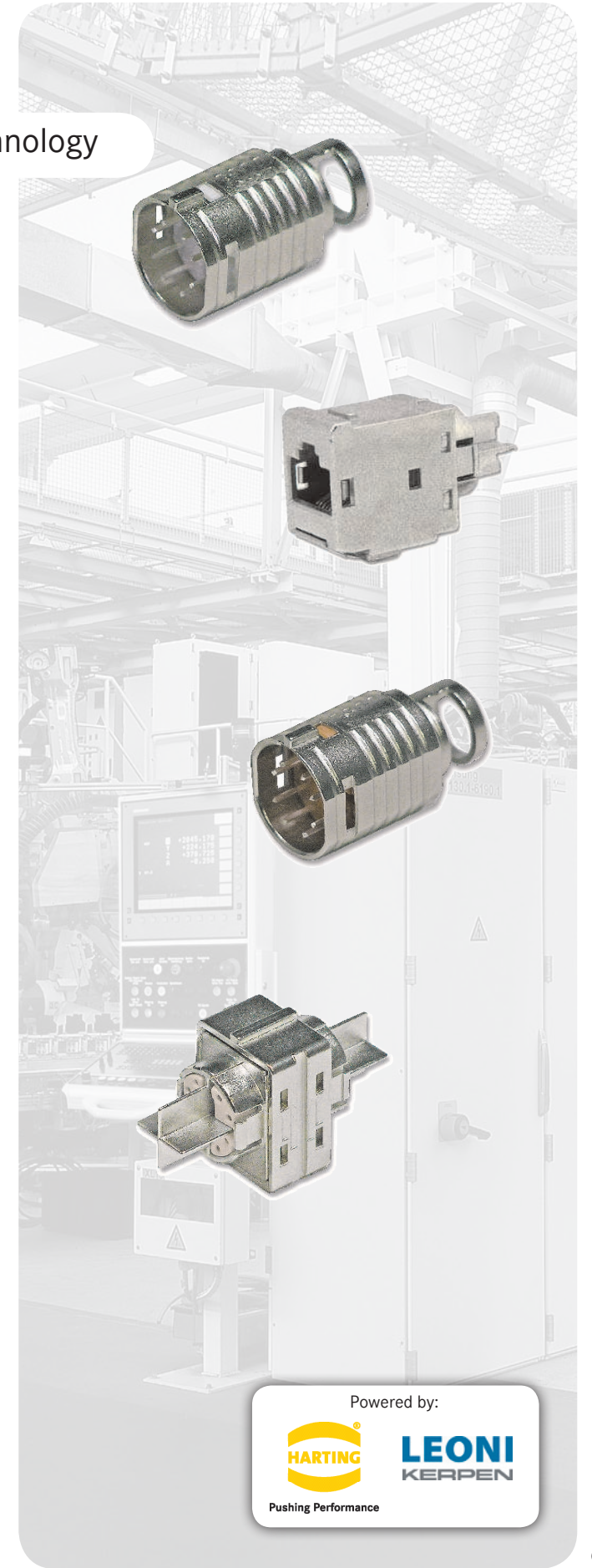
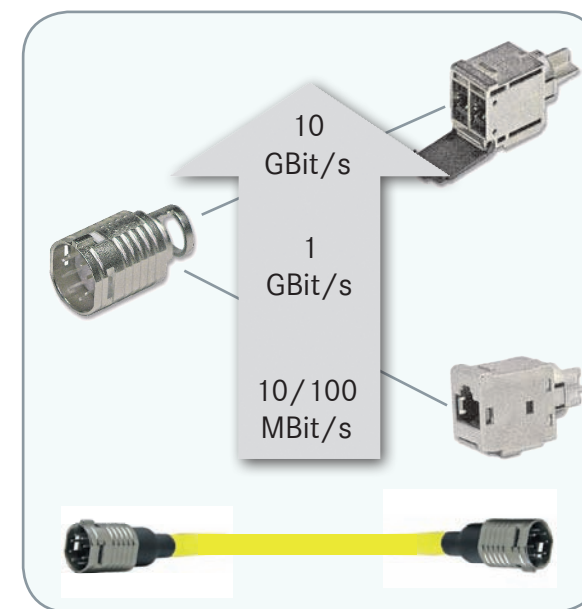



Variokeystone® 19" patch panel  
24 Ports, RJ45

unequipped

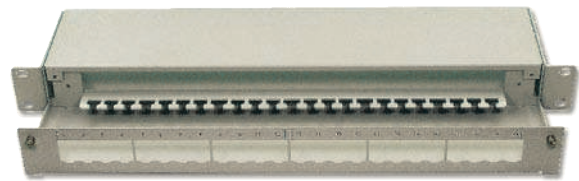

- 19", 1height unit, solid metal housing, pull-out
- Depth: 100mm
- Powder coated, light gray (RAL 7035)
- Ports numbered
- Includes 24 Variokeystone® Cat. 7 cable plugs and Cat. 6 RJ45 socket modules
- Cable grounding lug
- Fasteners included

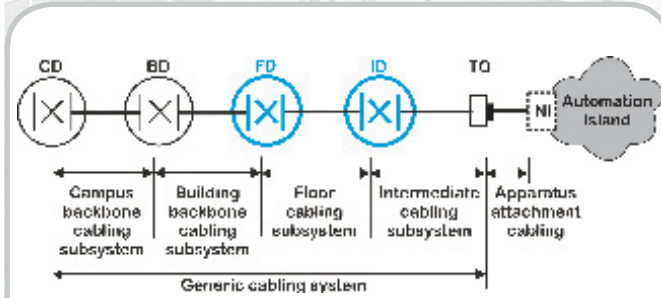

Part number	Product
09 45 851 1550	pull out type
09 45 851 1556	static type

MegaLineNet® Cat. 6 RJ45 patch cable  
250 MHz



- Fully shielded RJ45 patch cable, 1:1 pinout
- Gray, red plug with strain relief
- Cable sheath: FRNC
- Halogen-free, self-extinguishing
- Application: IEEE 802.3; 10BASE-T; 100BASE-T; 1000BASE-T

Part number	Length
09 45 781 1501	0.5 m
09 45 781 1502	1.0 m
09 45 781 1504	2.0 m
09 45 781 1506	3.0 m
09 45 781 1508	5.0 m

Variokeystone® DIN rail distribution panel  
2 ports, RJ45

unequipped



- Compact dual module
- Includes 2 Variokeystone® Cat. 7 cable connectors and Cat. 6 RJ45 jack module
- Powder coated, light gray (RAL 7035)
- IP 20 protection
- Snaps onto 35 mm rails
- Narrow, space-saving design
- Angled outlet

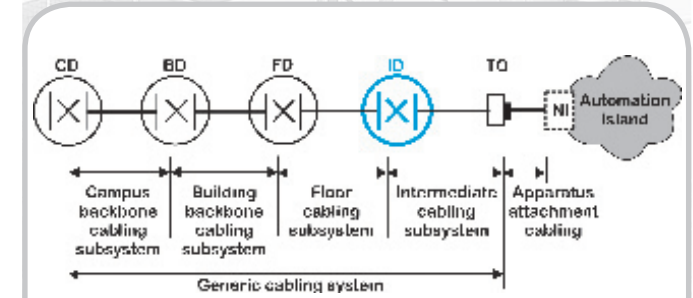

Part number: 09 45 851 1551

HARTING Industrial Ethernet Cat. 5/Cat. 5e patch cable, RJ45, PUR, 100 MHz



- Fully shielded RJ45 patch cable, 1:1 pinout
- Rugged industrial design
- Black, molded RJ45 plug, protected locking tab
- Sheath: PUR, LSZH
- Applications: IEEE 802.3; 10BASE-T; 100BASE-T; 1000BASE-T

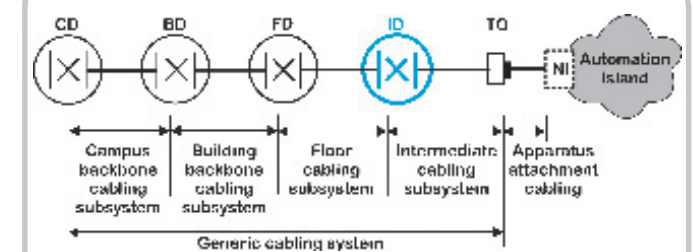

Part number	Length
09 45 971 1121	0.5 m
09 45 971 1122	1.0 m
09 45 971 1123	2.0 m
09 45 971 1124	3.0 m
09 45 971 1126	5.0 m

**Cat. 7<sub>A</sub> installation cable, FRNC**

Reinforced outer sheath, 1300 MHz, 4x2xAWG 22/1 PiMF

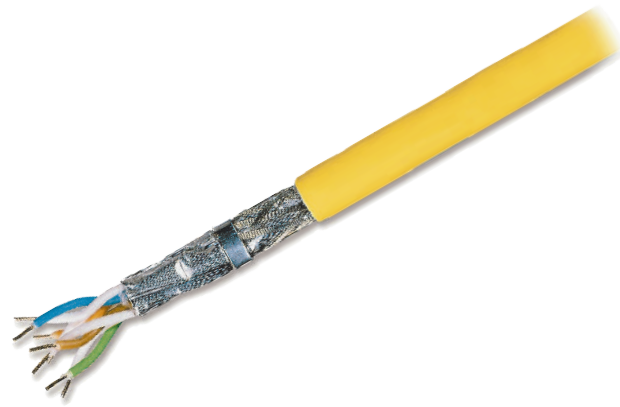

- Installation cable for industrial premises & systems
- Reinforced FRNC outer sheath
- Halogen-free per IEC 61034
- Flame retardant per IEC 60332-3-24
- Oil resistant per ICEA S-82-552 (60°)
- Sheath color: yellow (RAL 1021)
- Performance exceeds Cat. 7<sub>A</sub>
- Applications: IEEE 802.3; 10BASE-T;
- 100BASE-T; 1000BASE-T, 10GBASE-T
- supplied on 1000 m disposable drum
- weight: 84 kg

**Cable cross-section**

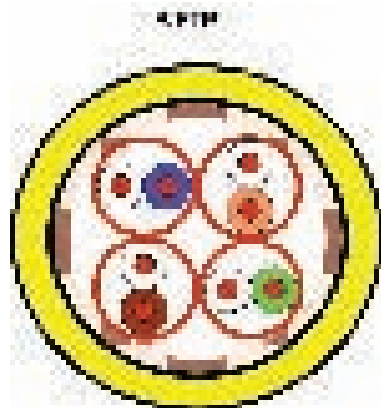

- Conductor: bare CU-wire; AWG 22/1
- Insulation: cellular PE, core  $\varnothing$  : 1,6 mm nominal
- Stranding element: pair
- Single shielding: aluminum-lined polyester foil (PiMF)
- Stranding: 4 pairs
- Full shielding: tinned CU braid
- Outer sheath: halogen-free, flame-retardant compound, FRNC

Part number: 09 45 600 0720

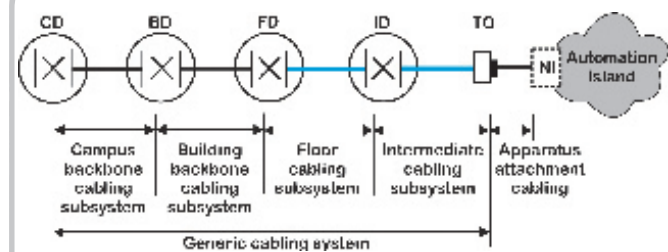

**Variokeystone®**

Cat. 7 Cable plug / RJ45 Cat. 6 Socket module



Cat. 7 Cable plug

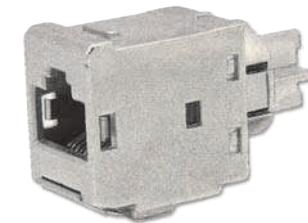

RJ45 Cat. 6 Socket module

Part number	Product
09 45 851 1552	Cat. 7 Cable plug
09 45 851 1554	RJ45 Cat. 6 socket module

**Cat. 7 Cable plug (white insert)**

- Interface between installation cable (AWG22/1) and IDC socket module
- Compatible with a range of Variokeystone® socket modules
- Large 360° shield contact
- Nickel-plated zinc diecast housing

**RJ45 Cat. 6 socket module**

- Nickel-plated zinc diecast housing
- Fully shielded
- Applications: IEEE 802.3; 10BASE-T; 100BASE-T; 1000BASE-T

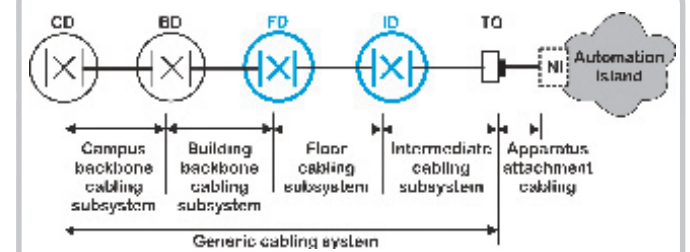

**Variokeystone®**

Link Extender Class F / Crossconnect Cable plug

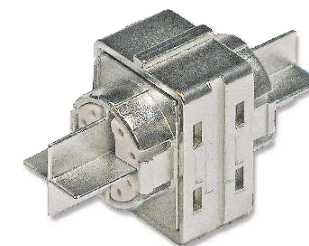

Link Extender Class F

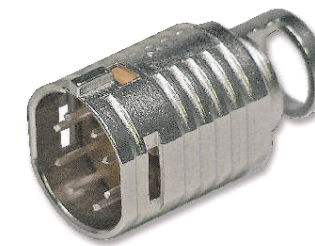

Crossconnect Cable plug

Part number	Product
09 45 851 1555	Link Extender Class F
09 45 851 1553	Crossconnect Cable plug

**Link Extender**

- To extend the length of existing cabling between a standard and a crossconnect cable plug
- Zinc diecast housing
- Fully shielded
- Applications: IEEE 802.3; 10BASE-T; 100BASE-T; 1000BASE-T

**Crossconnect Cable plug (red insert)**

- Interface between installation cables (AWG22/1) and IDC Link Extender
- Large 360° shield contact
- Nickel-plated zinc diecast housing



HARTING PushPull industrial outlet, for Variokeystone® RJ45 Socket modules

unequipped



- ISO/IEC 24702 compliant RJ45 PushPull interface, ideal for industrial premises cabling
- Includes 2 Variokeystone® Cat. 7 cable plugs and Cat. 6 RJ45 socket module
- 2 x IP 65/IP 67RJ45 ports, covers close automatically when patch cables are not inserted to maintain protection integrity
- Top or bottom cable entry
- Office patch cable can be plugged in (e.g. for test purposes)

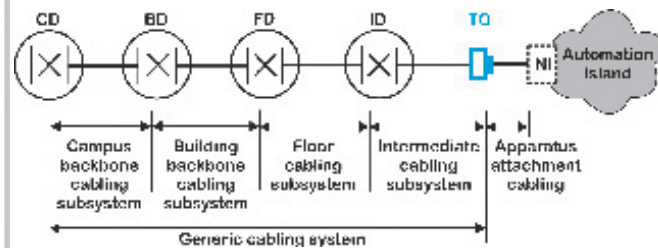

Part number: 09 45 845 1550

HARTING System cable PushPull RJ45 Cat. 6 PushPull RJ45 to PushPull RJ45



- Sheath material: PUR, LSZH
- Rugged industrial design, PushPull plug for easy handling
- ISO/IEC 24702 compliant PushPull interface
- Cat. 6 performance up to 250 MHz

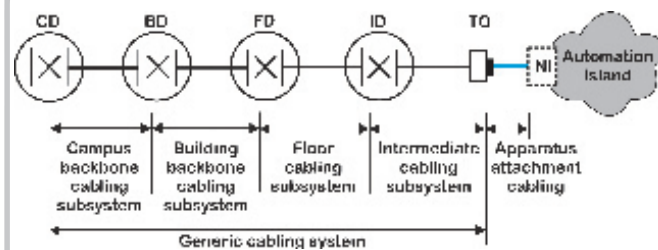

Part number	Length
09 45 745 2503	1.5 m
09 45 745 2505	3.0 m
09 45 745 2507	5.0 m
09 45 745 2512	10.0 m

HARTING System cable PushPull RJ45 Cat. 6 PushPull RJ45 to IP 20 RJ45



Part number	Length
09 45 701 2503	1.5 m
09 45 701 2505	3.0 m
09 45 701 2507	5.0 m
09 45 701 2512	10.0 m

Han® 3 A Industrie Outlet RJ45, für Variokeystone® RJ45 Socket module

unequipped

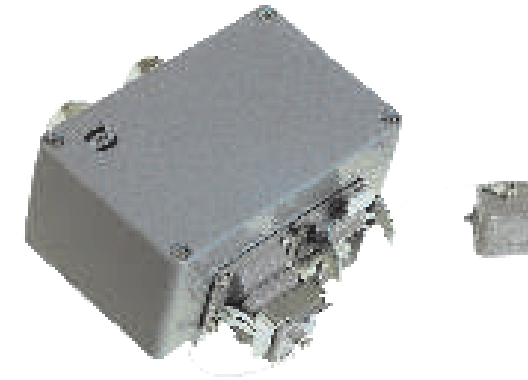

- IP 65/IP 67 protection
- Han® 3 A interface, with locking mechanism,
- Includes 2 Variokeystone® Cat. 7 cable plugs and Cat. 6 RJ45 socket module
- Metal – extremely rugged, suitable for use near welding robots
- Variokeystone® modules feature quick-connect technology for horizontal cables
- Cat. 6 performance (de-embedded test method), forward compatible with Cat. 6A, Cat. 7 and Cat. 7A
- Office patch cable can be plugged in (e.g. for test purposes)

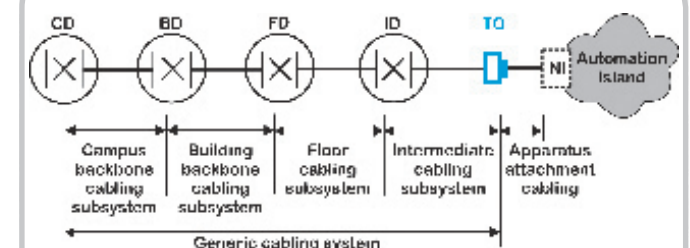

Part number: 20 79 302 0924

Han® 3 A System cable RJ45 Cat. 6 Han® 3 A RJ45 to Han® 3 A RJ45



- Extremely rugged RJ45, IP 65/IP 67 cords
- Han® 3 A metal interface, enhanced protection even at high temperatures
- Cat. 6 performance up to 250 MHz
- Plug compatible with a large number of automation controllers, devices and systems

Part number	Length
09 45 715 2503	1.5 m
09 45 715 2505	3.0 m
09 45 715 2507	5.0 m
09 45 715 2512	10.0 m

Han® 3 A System cable RJ45 Cat. 6 Han® 3 A RJ45 to IP 20 RJ45



Part number	Length
09 45 700 2503	1.5 m
09 45 700 2505	3.0 m
09 45 700 2507	5.0 m
09 45 700 2512	10.0 m

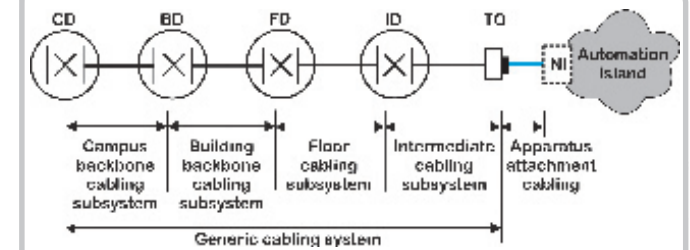



Panel feed throughs  
HARTING PushPull and Han® 3 A Interface

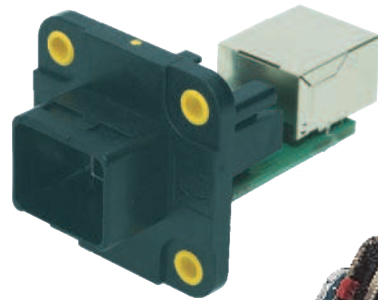

HARTING PushPull

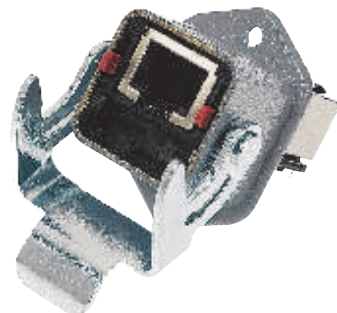

Han® 3 A Interface

- IP 65/IP 67 protection, PushPull or Han® 3 A interface, with locking mechanism
- Metal – extremely rugged, suitable for use near welding robots
- Compatible with PushPull or Han® 3 A cabling interface
- Cat. 5/Cat. 5e performance
- Link Class D per ISO/IEC 11801:2006
- Office patch cable can be plugged in (e.g. for test purposes)

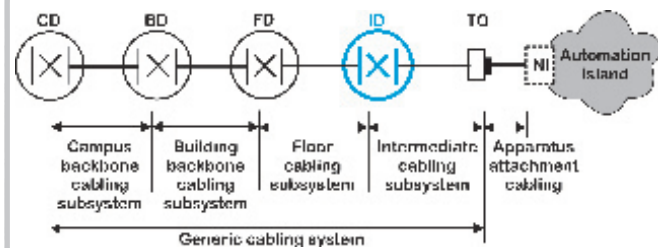

Part number	Product
09 45 245 1130	HARTING PushPull
09 45 215 1100	Han® 3 A Interface

Accessories and installation material / tools

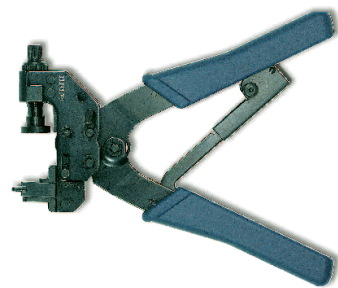

Variokeystone® pressing tool



Variokeystone® release tool

Pressing tool

- for Variokeystone® cable plugs and crossconnect plugs
- Simple to use

Variokeystone® release tool

- For disassembling Variokeystone® module
- Simple to use

Part number	Product
09 45 800 1550	pressing tool
09 45 800 1551	release tool

Product		VE	Part number
Variokeystone® 19"-patch panel, pull out type		1	09 45 851 1550
Variokeystone® 19"-patch panel, static type		1	09 45 851 1556
Variokeystone® DIN rail distribution panel		1	09 45 851 1551
Cat. 7 <sub>A</sub> installation cable		1000 m	09 45 600 0750
HARTING Ind. Ethernet patch cable Cat. 5	0.5 m	1	09 45 971 1121
	1.0 m	1	09 45 971 1122
	2.0 m	1	09 45 971 1123
	3.0 m	1	09 45 971 1124
	5.0 m	1	09 45 971 1126
MegaLineNet® patch cable Cat. 6	0.5 m	1	09 45 781 1501
	1.0 m	1	09 45 781 1502
	2.0 m	1	09 45 781 1504
	3.0 m	1	09 45 781 1506
	5.0 m	1	09 45 781 1508
Variokeystone® cable plugs Cat. 7		1	09 45 851 1552
Variokeystone® RJ45 Cat. 6 socket module		1	09 45 851 1554
Variokeystone® Link Extender Class F		1	09 45 851 1555
Variokeystone® cross connect cable plug		1	09 45 851 1553
HARTING PushPull IO (with 2x RJ45 Vario)		1	09 45 845 1550
System cable PushPull to PushPull	1.5 m	1	09 45 745 2503
	3.0 m	1	09 45 745 2505
	5.0 m	1	09 45 745 2507
	10.0 m	1	09 45 745 2512
System cable PushPull to IP 20	1.5 m	1	09 45 701 2503
	3.0 m	1	09 45 701 2505
	5.0 m	1	09 45 701 2507
	10.0 m	1	09 45 701 2512
Han® 3 A industrial Outlet (with 2x RJ45 Vario)		1	20 79 302 0924
System cable Han® 3A to Han® 3 A	1.5 m	1	09 45 715 2503
	3.0 m	1	09 45 715 2505
	5.0 m	1	09 45 715 2507
	10.0 m	1	09 45 715 2512
System cable Han® 3 A to IP 20	1.5 m	1	09 45 700 2503
	3.0 m	1	09 45 700 2505
	5.0 m	1	09 45 700 2507
	10.0 m	1	09 45 700 2512
Panel feed through HARTING PushPull		1	09 45 245 1130
Panel feed through Han® 3 A Interface		1	09 45 215 1100
Variokeystone® pressing tool		1	09 45 800 1550
Variokeystone® release tool		1	09 45 800 1551





Bitte schicken Sie uns weitere Kataloge:

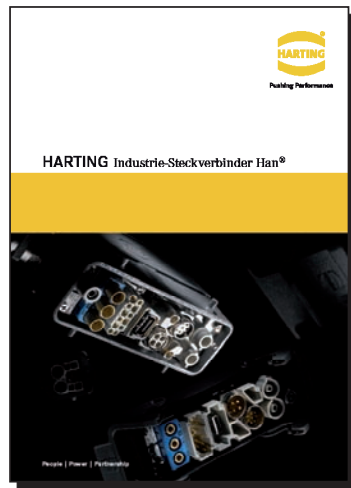

Industrie-Steckverbinder Han®

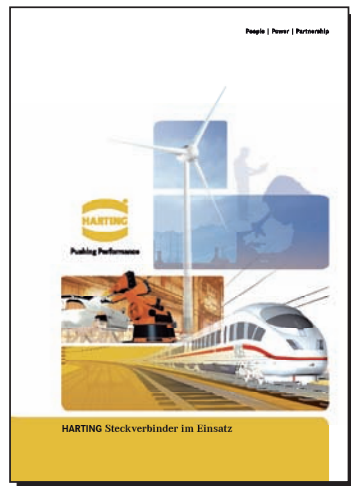

Applikationsbroschüre

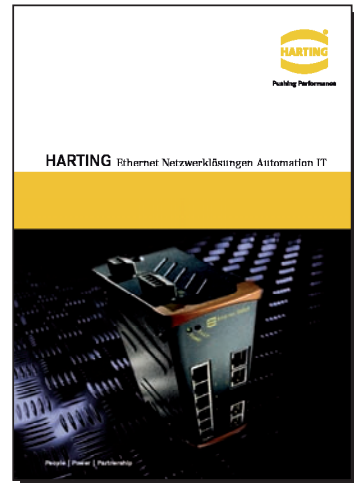

Ethernet Netzwerklösungen Automation IT

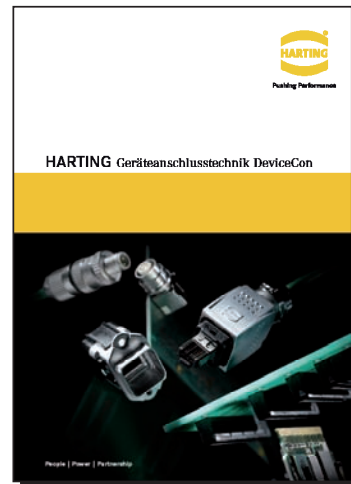

Geräteanschlusstechnik DeviceCon



Steckverbinder DIN 41 612



CD-ROM HARKIS® basic

DVD HARKIS® basic

Absender: \_\_\_\_\_

Firma: \_\_\_\_\_

Abteilung: \_\_\_\_\_

Name: \_\_\_\_\_

Vorname: \_\_\_\_\_

Funktion: \_\_\_\_\_

Straße: \_\_\_\_\_

PLZ/Ort: \_\_\_\_\_

Land: \_\_\_\_\_

Tel.: \_\_\_\_\_

Fax: \_\_\_\_\_

E-Mail: \_\_\_\_\_

Bitte schicken oder faxen Sie Ihre Bestellung an Ihre HARTING-Vertriebsgesellschaft bzw. -Vertretung (siehe Adressseiten) oder besuchen Sie uns im Internet unter [www.HARTING.com](http://www.HARTING.com).

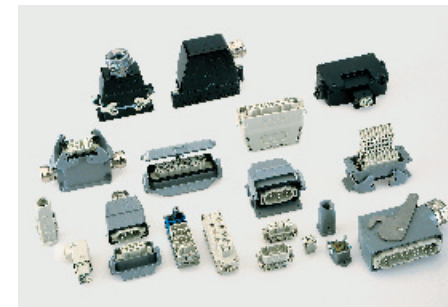

Industriesteckverbinder Han®

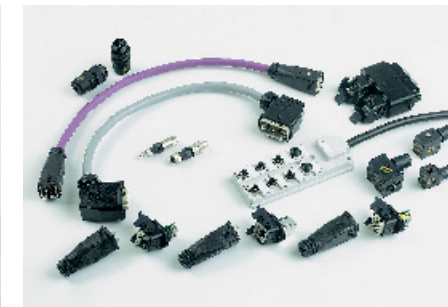

Feldbus- und Sensor-/Aktorkomponenten, Han-InduNet®-Systemkabel

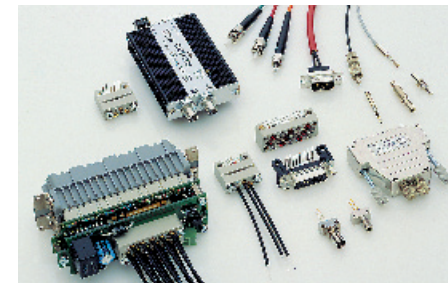

Faseroptische Datenübertragung, Komponenten und Systeme (LWL)

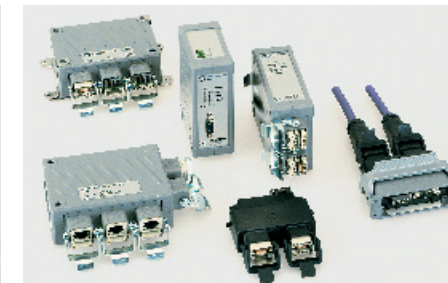

Netzwerkkomponenten für die industrielle Kommunikation

Tochtergesellschaften – weltweit



**Belgien:** HARTING N.V./S.A.  
Z.3 Doornveld 23, B-1731 Zellik  
Tel. +322/4660190, Fax +322/4667855  
E-Mail: [be@HARTING.com](mailto:be@HARTING.com)

**Brasilien:** HARTING Ltda.  
Av. Dr. Lino de Moraes, Pq. Jabaguara, 255  
CEP 04360-001 - São Paulo - SP - Brazil  
Tel. +5511/5035-0073, Fax +5511/5034-4743  
E-Mail: [br@HARTING.com](mailto:br@HARTING.com), Internet: [www.HARTING.com.br](http://www.HARTING.com.br)

**China:** Zhuhai HARTING, Limited Shanghai branch  
Room 5403, 300 Huaihai Zhong Road  
Hong Kong New World Tower, Luwan District, P.R.C  
Shanghai 200021, China  
Tel. +86 21 - 63 86 22 00, Fax +86 21 - 63 86 86 36  
E-Mail: [cn@HARTING.com](mailto:cn@HARTING.com)

**Deutschland:** HARTING Deutschland GmbH & Co. KG  
Simeons carré 1 · D-32427 Minden  
Tel. (0571) 8896-0, Fax (0571) 8896-282  
E-Mail: [de@HARTING.com](mailto:de@HARTING.com), Internet: [www.HARTING.com](http://www.HARTING.com)

**Geschäftsstelle Deutschland:** HARTING Deutschland GmbH & Co. KG  
Blankenauer Straße 99, D-09113 Chemnitz  
Tel. +49 0371 429211, Fax +49 0371 429222  
E-Mail: [de@HARTING.com](mailto:de@HARTING.com)

**Finnland:** HARTING Oy  
Hakamäenkuja 11 A, FIN-01510 Vantaa  
Tel. +358 9 350 873 00, Fax +358 9 350 873 20  
E-Mail: [fi@HARTING.com](mailto:fi@HARTING.com)

**Frankreich:** HARTING France  
181 avenue des Nations, Paris Nord 2  
BP 66058 Tremblay en France  
F-95972 Roissy Charles de Gaulle Cédex  
Tel. +33149383400, Fax +33148632306  
E-Mail: [fr@HARTING.com](mailto:fr@HARTING.com)

**Großbritannien:** HARTING Ltd.  
Caswell Road, Brackmills Industrial Estate  
GB-Northampton, NN4 7PW  
Tel. +441604/766886, 827500, Fax +441604/706777  
E-Mail: [gb@HARTING.com](mailto:gb@HARTING.com), Internet: [www.HARTING.com.uk](http://www.HARTING.com.uk)

**Hongkong:** HARTING (HK) Limited, Regional Office Asia Pacific  
4208 Metroplaza Tower 1, 223 Hing Fong Road  
Kwai Fong, N. T., Hong Kong  
Tel. +852/2423-7338, Fax +852/2480-4378  
E-Mail: [ap@HARTING.com](mailto:ap@HARTING.com), Internet: [www.HARTING.com.hk](http://www.HARTING.com.hk)

**Indien:** HARTING India Private Limited  
No. D. 4th Floor, 'Doshi Towers', No. 156 Poonamallee High Road,  
Kilpauk, Chennai 600 010, Tamil Nadu, Chennai  
Tel. +91-44-4356 0415/6, Fax +91-44-4356 0417  
E-Mail: [in@HARTING.com](mailto:in@HARTING.com), Internet: [www.HARTING.com](http://www.HARTING.com)

**Italien:** HARTING SpA  
Via Dell'Industria 7, I-20090 Vimodrone (Milano),  
Tel. +3902/250801, Fax +3902/2650597,  
E-Mail: [it@HARTING.com](mailto:it@HARTING.com)

**Japan:** HARTING K. K.  
Yusen Shin-Yokohama 1 Chome Bldg., 2F, 1-7-9, Shin-Yokohama  
Kohoku-ku, Yokohama, 222-0033 Japan  
Tel. +81 45 476 3456, Fax +81 45 476 3466  
E-Mail: [jp@HARTING.com](mailto:jp@HARTING.com), Internet: [www.HARTING.co.jp](http://www.HARTING.co.jp)

**Korea:** HARTING Korea Limited  
#308 Leaders Bldg., 342-1, Yatap-dong, Bundang-gu,  
Sungnam-City, Kyunggi-do, 463-828, Korea  
Tel. +82-31-781-4615, Fax +82-31-781-4616  
E-Mail: [kr@HARTING.com](mailto:kr@HARTING.com)

**Niederlande:** HARTING B.V.  
Larenweg 44, NL-5234 KA 's-Hertogenbosch  
Postbus 3526, NL-5203 DM 's-Hertogenbosch  
Tel. +3173/6410404, Fax +3173/6440699  
E-Mail: [nl@HARTING.com](mailto:nl@HARTING.com)

**Norwegen:** HARTING A/S.  
Østensjøveien 36, N-0667 Oslo,  
Tel. +4722/700555, Fax +4722/700570  
E-Mail: [no@HARTING.com](mailto:no@HARTING.com)

**Österreich:** HARTING Ges. m. b. H.  
Deutschstraße 3, A-1230 Wien  
Tel. +431/6162121, Fax +431/6162121-21  
E-Mail: [at@HARTING.com](mailto:at@HARTING.com)

**Polen:** HARTING Eastern Europe GmbH  
Przedstawicielstwo w Polsce  
ul. Kamieńskiego 201-219, 51-126 Wrocław  
Tel. +48 71-352 81 71, Tel. +48 71-352 81 74  
Fax +48 71-320 74 44  
E-Mail: [pl@HARTING.com](mailto:pl@HARTING.com), Internet: [www.HARTING.pl](http://www.HARTING.pl)

**Portugal:** HARTING Iberia, S. A.  
Avda. Josep Tarradellas, 20-30, 4º 6º, E-08029 Barcelona  
Tel. +351 219.673.177, Fax +351.219.678.457  
E-Mail: [es@HARTING.com](mailto:es@HARTING.com)

**Russland:** HARTING ZAO  
ul. Tobolskaja 12, Saint Petersburg, 194044 Russia  
Tel. +7/812/3276477, Fax +7/812/3276478  
E-Mail: [ru@HARTING.com](mailto:ru@HARTING.com), Internet: [www.HARTING.ru](http://www.HARTING.ru)

**Schweden:** HARTING AB  
Gustavslundsvägen 141 B 4tr, 167 51 Bromma  
Tel. +468/4457171, Fax +468/4457170  
E-Mail: [se@HARTING.com](mailto:se@HARTING.com)

**Schweiz:** HARTING AG  
Industriestrasse 26, CH-8604 Volketswil  
Tel. +41 44 908 20 60, Fax +41 44 908 20 69  
E-Mail: [ch@HARTING.com](mailto:ch@HARTING.com)

**Singapur:** HARTING Singapore Pte Ltd.  
No. 1 Coleman Street, #B1-21 The Adelphi, Singapore 179803  
Tel. +6562252585, Fax +6562259947  
E-Mail: [sg@HARTING.com](mailto:sg@HARTING.com)

**Spanien:** HARTING Iberia S. A.  
Josep Tarradellas 20-30 4º 6º, E-08029 Barcelona  
Tel. +34 933 638 475, Fax +34 934 199 585  
E-Mail: [es@HARTING.com](mailto:es@HARTING.com)

**Taiwan:** HARTING R.O.C. Limited  
Room 6, 10 Floor, No. 171, Sung-Te-Road, Taipei, 110 Taiwan  
Tel. +886-2-2346-3177, Fax +886-2-2346-2690  
E-Mail: [tw@HARTING.com](mailto:tw@HARTING.com)

**Tschechische Republik:** HARTING spol. s.r.o.,  
Mlýnská 2, 16000 Praha 6  
Tel. +420 220 380 460, Fax +420 220 380 461  
E-Mail: [cz@HARTING.com](mailto:cz@HARTING.com), Internet: [www.HARTING.cz](http://www.HARTING.cz)

**Ungarn:** HARTING Eastern Europe GmbH  
Magyarországi Kereskedelmi Képviselete, 1119 Budapest  
Fehérvári út 89-95, II. emelet 217/A.  
Tel. +36-1-205 3464, Fax +36-1-205 3465  
E-Mail: [hu@HARTING.com](mailto:hu@HARTING.com), Internet: [www.HARTING.hu](http://www.HARTING.hu)

**USA:** HARTING Inc. of North America  
1370 Bowes Road, Elgin, Illinois 60123  
Tel. +1 (877) 741-1500 (toll free)  
Fax +1 (866) 278-0307 (Inside Sales)  
Fax +1 (847) 717-9430 (Sales and Marketing)  
E-Mail: [us@HARTING.com](mailto:us@HARTING.com), Internet: [www.HARTING-USA.com](http://www.HARTING-USA.com)

**Ost-Europa:** HARTING Eastern Europe GmbH  
Bamberger Straße 7, D-01187 Dresden  
Tel. +49 351 / 4361760, Fax +49 351 / 4361770  
E-Mail: [Eastern.Europe@HARTING.com](mailto:Eastern.Europe@HARTING.com)

**Andere Länder:** HARTING Electric GmbH & Co. KG  
Postfach 1473, D-32328 Espelkamp  
Tel. +495772/47-97100, Fax +495772/47-495  
E-Mail: [electric@HARTING.com](mailto:electric@HARTING.com)



Pushing Performance

Vertretungen – weltweit



**Argentinien:** Condel Electronica  
Julian Agüero 3355  
(1605) Munro, Pcia. de Buenos Aires  
Tel. + Fax +54114762.0118  
E-Mail: [mediavicondel@arnet.com.ar](mailto:mediavicondel@arnet.com.ar)

**Australien:** ADILAM Electronics Pty. Ltd.  
14 Nicole Close, North Bayswater, 3153 Victoria  
Tel. +61 3 9737 4900, Fax +61 3 9737 4999  
E-Mail: [mark.c@adilam.com.au](mailto:mark.c@adilam.com.au)  
Internet: [www.adilam.com.au](http://www.adilam.com.au)

**Bulgarien:** COMET ELECTRONICS  
16, Tsar Samuil Str., BG-1000 Sofia  
Tel. +359-2-9155800, Fax +359-2-9540384  
E-Mail: [office@comet.bg](mailto:office@comet.bg)  
Internet: [www.comet.bg](http://www.comet.bg)

**Dänemark:** Knud Wexøe A/S  
Skaettekaeret 11, P.O. Box 152, DK-2840 Holte  
Tel. +4545465800, Fax +4545465801  
E-Mail: [wexoe@wexoe.dk](mailto:wexoe@wexoe.dk)  
Internet: [www.wexoe.dk](http://www.wexoe.dk)

**Estland:** SKS-tehnika Oü  
Mustamäe tee 55, EE-10621 Tallinn  
Tel. +372 6819 234, Fax +372 6819 235  
E-Mail: [peeter.kuus@sksi.fi](mailto:peeter.kuus@sksi.fi)

**Finnland:** SKS-automaatio OY  
Martinkyläntie 50, FIN-01721 Vantaa  
Tel. +3589852661, Fax +35898526820  
E-Mail: [automaatio@sksi.fi](mailto:automaatio@sksi.fi)

**Island:** Smith & Norland  
Nóatún 4, IS - 105 Reykjavik  
Tel. +354 520 3000, Fax +354 520 3111  
E-Mail: [olaf@smnor.is](mailto:olaf@smnor.is)  
Internet: [www.smnor.is](http://www.smnor.is)

**Israel:** MIGVAN Technologies & Engineering Ltd.  
13 Hashiloah St., P.O.Box 7022, IL - Petach Tikva 49170  
Tel. +972 3 9240784, Fax +972 3 9240787  
E-Mail: [info@mte.co.il](mailto:info@mte.co.il)  
Internet: [www.mte.co.il](http://www.mte.co.il)

**Polen:** Soyter Sp. z o.o.  
ul. Warszawska 3, 05-082 Warszawa - Stare Babice  
Tel. +48 22 722 0 685, Fax +48 22 722 0 550  
E-Mail: [handlowy@soyter.com.pl](mailto:handlowy@soyter.com.pl)  
Internet: [www.soyter.com](http://www.soyter.com)

**Südafrika:** HellermannTyton Pty Ltd.  
Private Bag X158 Rivonia 2128, 34 Milky Way Avenue  
Linbro Business Park 2065, Johannesburg, South Africa  
Tel. +27(0)11879-6600, Fax +27(0)11879-6606  
E-Mail: [sales.jhb@hellermann.co.za](mailto:sales.jhb@hellermann.co.za)

**Türkei:** Gökhan Elektrik San. Tic. Ltd. Sti.  
Perpa Elektrikçiler İş Merkezi A Blok  
Kat:7-8-9 No.694, TR - 80270 Okmeydanı/Istanbul  
Tel. +90(212) 2213236 (pbx), Fax +90(212) 2213240  
E-Mail: [gokhan@gokhanelektrik.com](mailto:gokhan@gokhanelektrik.com)  
Internet: [www.gokhanelektrik.com](http://www.gokhanelektrik.com)

**Ukraine:** Incomtech Ltd.  
4 Lermontovskaya St., UA-04050 Kiev  
Tel. +380-44-213-3641, Fax +380-44-213-3814  
E-Mail: [eletch@incomtech.com.ua](mailto:eletch@incomtech.com.ua)  
Internet: [www.incomtech.com.ua](http://www.incomtech.com.ua)

**Ungarn:** Mile Kft.  
Mádi u. 52, H-1104 Budapest  
Tel. +36-1-431-9800, Fax +36-1-431-9817  
E-Mail: [milekft@mile-kft.hu](mailto:milekft@mile-kft.hu)  
Internet: [www.mile-kft.hu](http://www.mile-kft.hu)

Fertigungsstätten



China · Deutschland · Großbritannien · Rumänien · Schweiz

Global Business Unit Electric



**HARTING Electric GmbH & Co. KG**  
Postfach 1473, D-32328 Espelkamp  
Tel. +49 57 72 / 47-97 100, Fax +49 57 72 / 47-495  
E-Mail: [electric@HARTING.com](mailto:electric@HARTING.com)  
Internet: <http://www.HARTING.com>





**Pushing Performance**

[www.HARTING.com](http://www.HARTING.com)