



Chipsmall Limited consists of a professional team with an average of over 10 year of expertise in the distribution of electronic components. Based in Hongkong, we have already established firm and mutual-benefit business relationships with customers from,Europe,America and south Asia,supplying obsolete and hard-to-find components to meet their specific needs.

With the principle of “Quality Parts,Customers Priority,Honest Operation,and Considerate Service”,our business mainly focus on the distribution of electronic components. Line cards we deal with include Microchip,ALPS,ROHM,Xilinx,Pulse,ON,Everlight and Freescale. Main products comprise IC,Modules,Potentiometer,IC Socket,Relay,Connector.Our parts cover such applications as commercial,industrial, and automotives areas.

We are looking forward to setting up business relationship with you and hope to provide you with the best service and solution. Let us make a better world for our industry!



Contact us

Tel: +86-755-8981 8866 Fax: +86-755-8427 6832

Email & Skype: info@chipsmall.com Web: www.chipsmall.com

Address: A1208, Overseas Decoration Building, #122 Zhenhua RD., Futian, Shenzhen, China



5 4 3 2 1

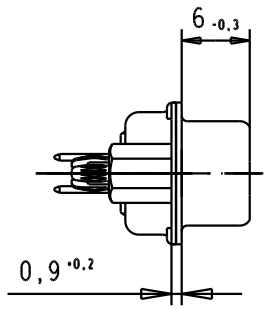
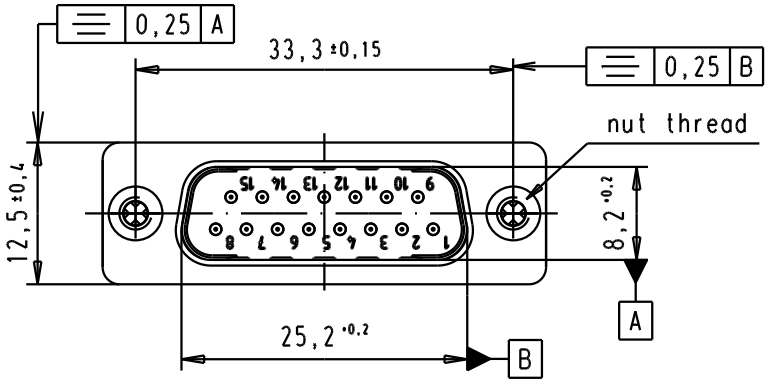

SPECIFICATION

Mating Cycles	500
Filter type	C
Capacitance	47pf ± 20%
Working Voltage	100v
Current Rating	7,5A
Insulation Resistance	>1GΩ

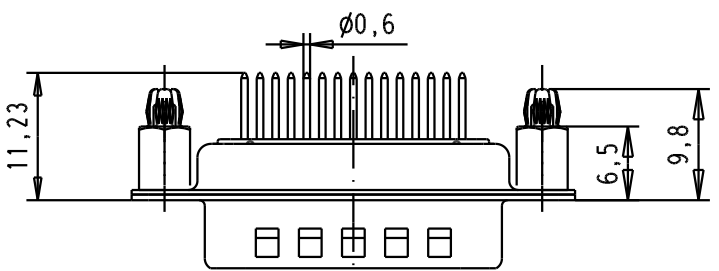

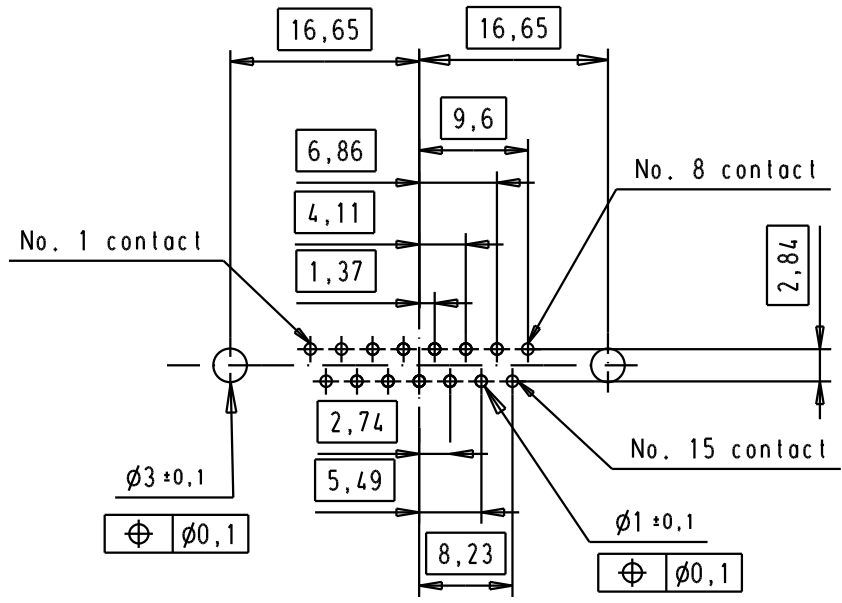

PCB Layout, Component side
PCB thickness 1,6 mm

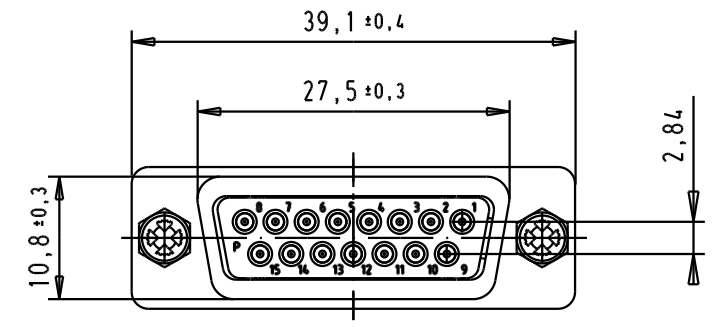

FREQUENCY (MHz)	ATTENUATION dB
5	-
10	-
50	-
100	-
500	30dB
1000	35dB

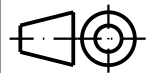

D
C
B
A

					Dat.	Name	 All Dim. in mm Orig. Size DIN A 4	D-Sub, male, straight, 15 Poles, solder pins, tin plated shell with dimples, spacer nuts and board-locks	Mo?Mslab/ Scale 1.5:1
					Detail.	8- JUL -02 CV			
					Insp.				
					Stand.				
09642227216	M3		33267	17/11/05	JMDR	HARTING EURL F-95972 Paris			
09642227215	UNC 4-40		31058	8- JUL -02	CV				
Part number	Nut thread		Mod.	Dat.	Name				
								TB 0964222721x	Blatt/ Page 2 / 3
								Sub.	3