



Chipsmall Limited consists of a professional team with an average of over 10 year of expertise in the distribution of electronic components. Based in Hongkong, we have already established firm and mutual-benefit business relationships with customers from,Europe,America and south Asia,supplying obsolete and hard-to-find components to meet their specific needs.

With the principle of “Quality Parts,Customers Priority,Honest Operation,and Considerate Service”,our business mainly focus on the distribution of electronic components. Line cards we deal with include Microchip,ALPS,ROHM,Xilinx,Pulse,ON,Everlight and Freescale. Main products comprise IC,Modules,Potentiometer,IC Socket,Relay,Connector.Our parts cover such applications as commercial,industrial, and automotives areas.

We are looking forward to setting up business relationship with you and hope to provide you with the best service and solution. Let us make a better world for our industry!



## Contact us

Tel: +86-755-8981 8866 Fax: +86-755-8427 6832

Email & Skype: info@chipsmall.com Web: www.chipsmall.com

Address: A1208, Overseas Decoration Building, #122 Zhenhua RD., Futian, Shenzhen, China



Alle Rechte vorbehalten/ All rights reserved

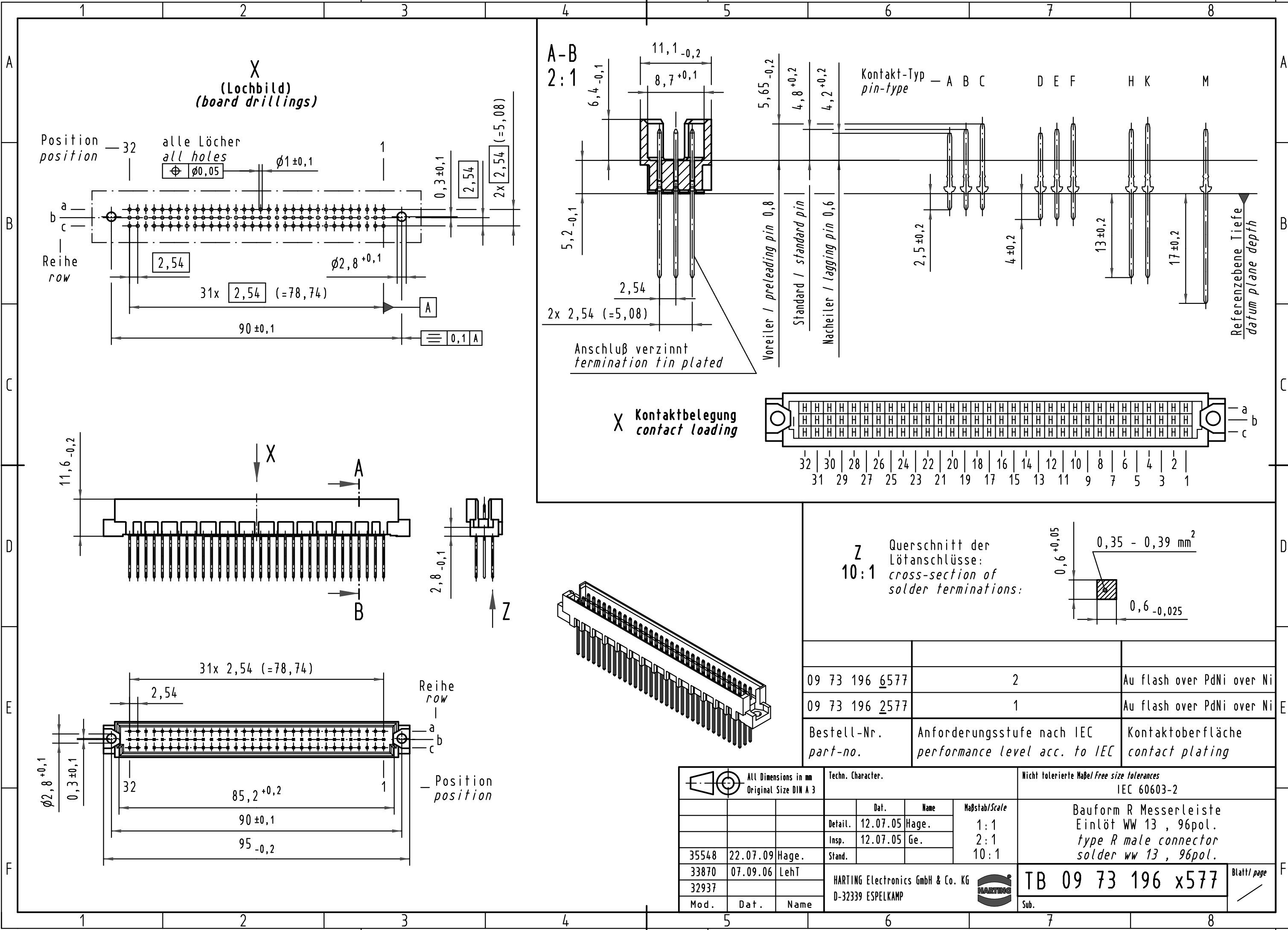

**X**  
(Lochbild)  
(board drillings)

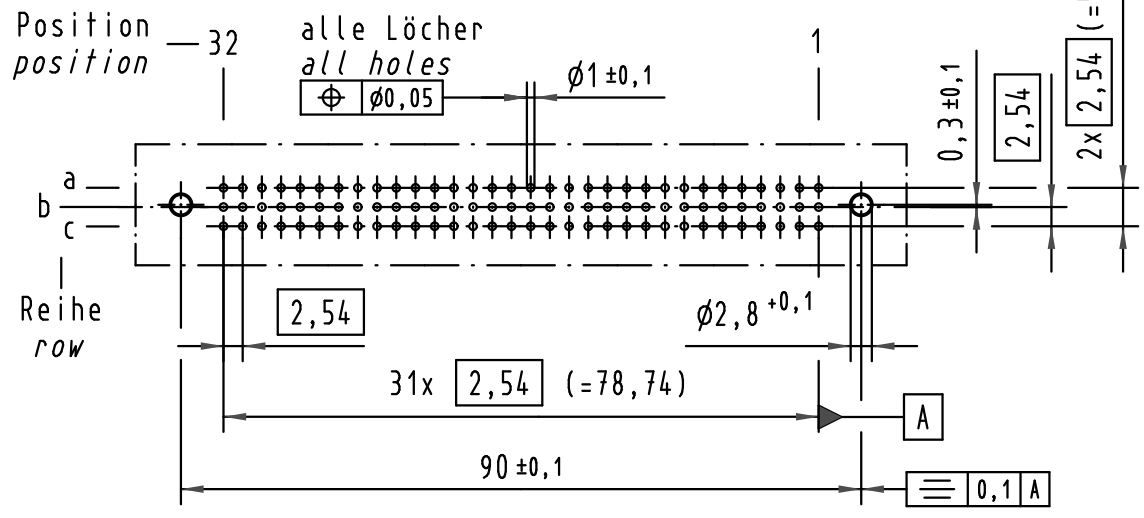

**A-B**  
2:1

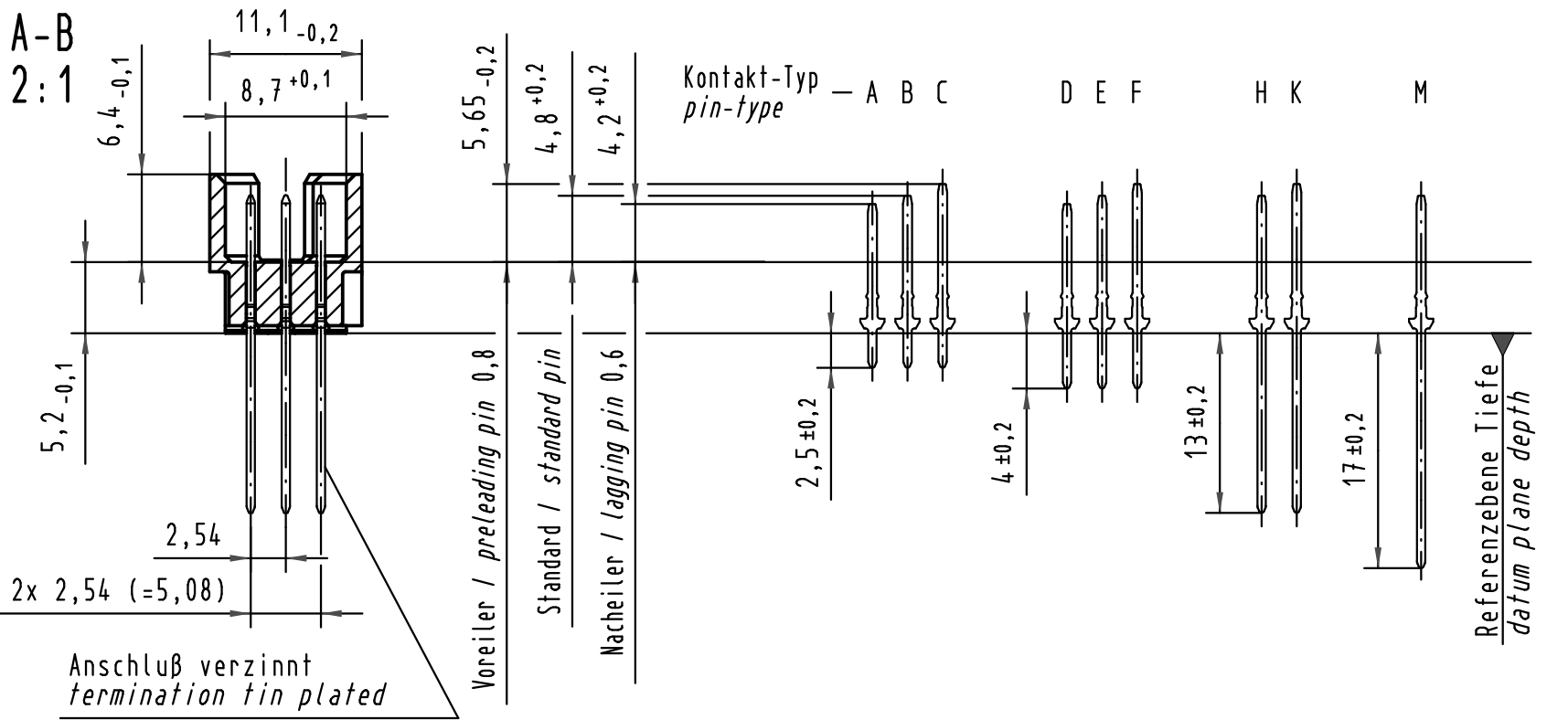

**X** Kontaktbelegung  
contact loading

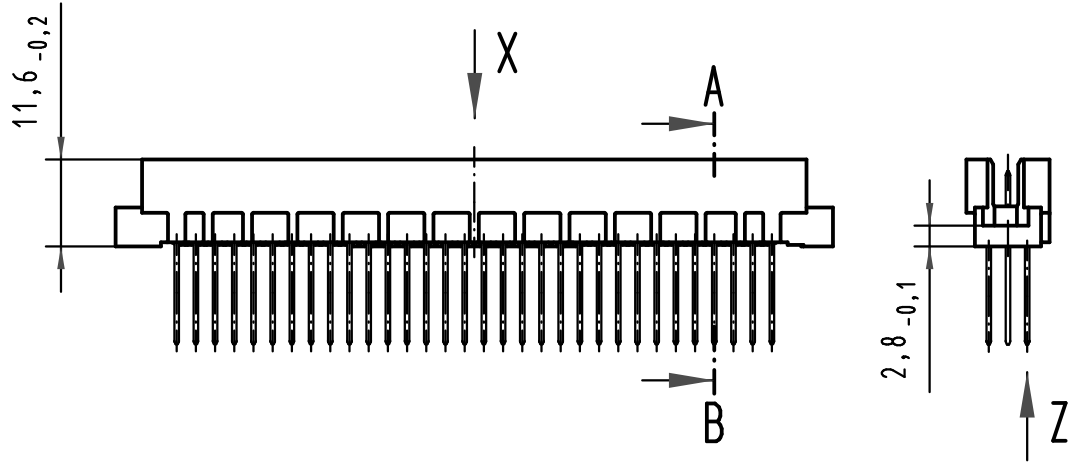
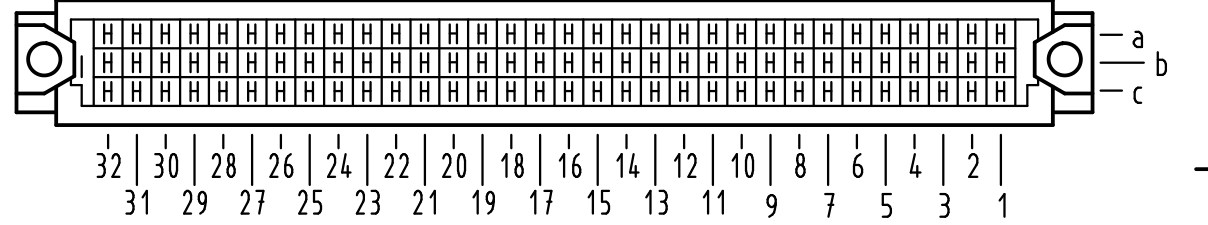

**Z**  
10:1

Querschnitt der  
Lötanschlüsse:  
cross-section of  
solder terminations:

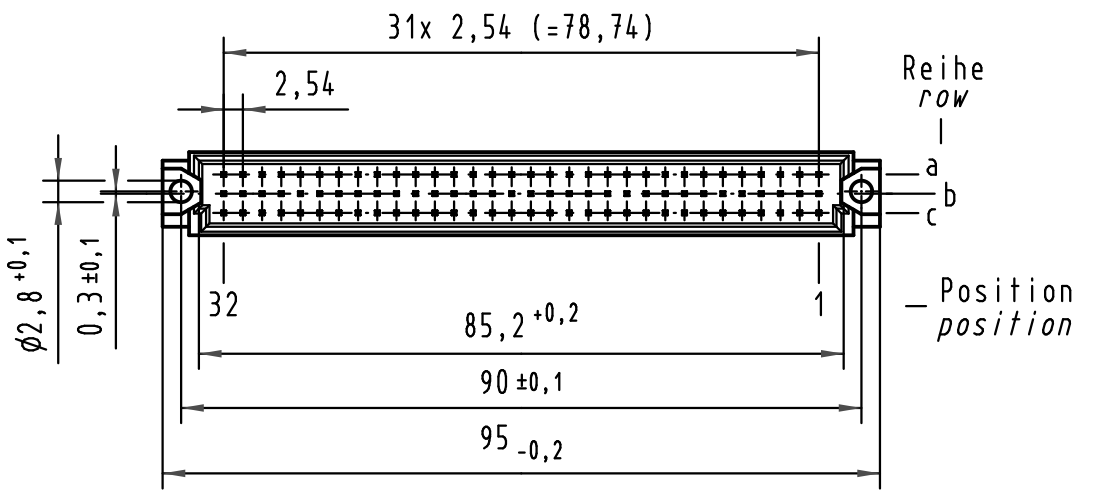
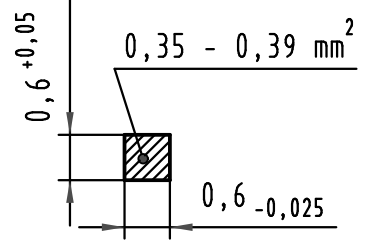

09 73 196 6577	2	Au flash over PdNi over Ni
09 73 196 2577	1	Au flash over PdNi over Ni
Bestell-Nr. part-no.	Anforderungsstufe nach IEC performance level acc. to IEC	Kontaktoberfläche contact plating

All Dimensions in mm Original Size DIN A 3			Techn. Character.			Nicht tolerierte Maß/Free size tolerances IEC 60603-2			
			Dat.	Name	Maßstab/Scale	Bauform R Messerleiste Einlöt WW 13 , 96pol. type R male connector solder ww 13 , 96pol.			
			Detail.	12.07.05 Hage.					1:1
			Insp.	12.07.05 Ge.					2:1
35548	22.07.09	Hage.	Stand.		10:1	<b>TB 09 73 196 x577</b>			
33870	07.09.06	LehT							
32937									
Mod.	Dat.	Name	HARTING Electronics GmbH & Co. KG D-32339 ESPELKAMP			Blatt/ page Sub.			