



Chipsmall Limited consists of a professional team with an average of over 10 year of expertise in the distribution of electronic components. Based in Hongkong, we have already established firm and mutual-benefit business relationships with customers from,Europe,America and south Asia,supplying obsolete and hard-to-find components to meet their specific needs.

With the principle of “Quality Parts,Customers Priority,Honest Operation,and Considerate Service”,our business mainly focus on the distribution of electronic components. Line cards we deal with include Microchip,ALPS,ROHM,Xilinx,Pulse,ON,Everlight and Freescale. Main products comprise IC,Modules,Potentiometer,IC Socket,Relay,Connector.Our parts cover such applications as commercial,industrial, and automotives areas.

We are looking forward to setting up business relationship with you and hope to provide you with the best service and solution. Let us make a better world for our industry!



Contact us

Tel: +86-755-8981 8866 Fax: +86-755-8427 6832

Email & Skype: info@chipsmall.com Web: www.chipsmall.com

Address: A1208, Overseas Decoration Building, #122 Zhenhua RD., Futian, Shenzhen, China



THIS DRAWING IS UNPUBLISHED. RELEASED FOR PUBLICATION NOV., 2004.
 © COPYRIGHT 2004 BY TYCO ELECTRONICS CORPORATION. ALL RIGHTS RESERVED.

LOC	DIST	REVISIONS					
E	B	P	LTR	DESCRIPTION	DATE	DWN	APVD
				SEE SHEET 1			

COMPONENTS

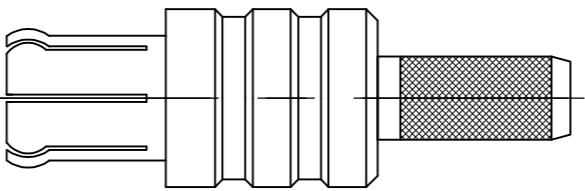
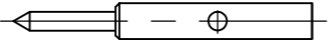
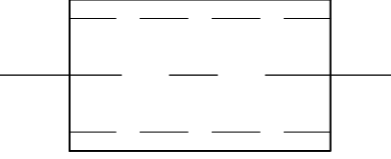
	MAIN BODY (ITEM 2, 3 & 5)	CENTRE CONTACT (ITEM 1)	PUSHER SLEEVE (ITEM 4)		
					

ASSEMBLY INSTRUCTION

CABLES: RG174A/U, 188A/U, 316/U, URM95, KX3B, KX22A

STEP 1

1. SLIDE METAL CRIMP FERRULE OVER CABLE

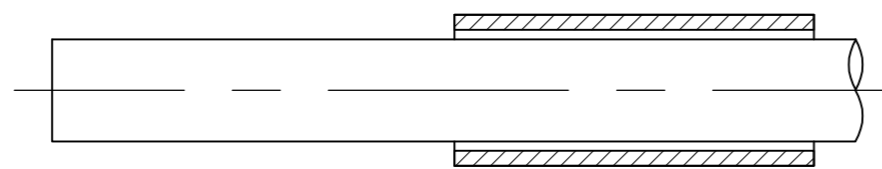

STEP 2

1. STRIP CABLE TO DIMENSIONS AS SHOWN

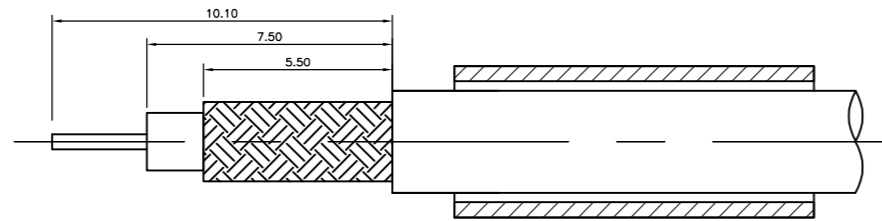

STEP 3

1. FIT CONTACT OVER CENTRE CONDUCTOR TO BUTT AGAINST DIELECTRIC.
2. CRIMP CONTACT USING TOOL AS NOTED ON PAGE 1 NOTE 5

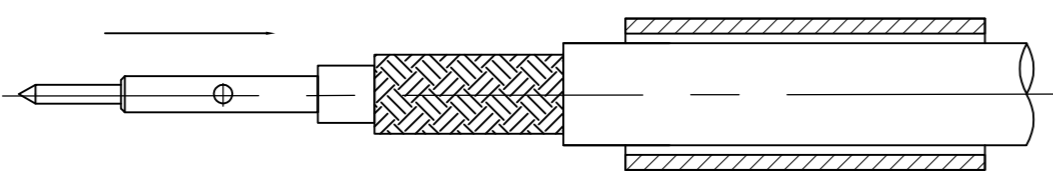

STEP 4

1. PRESS SUB-ASSEMBLY INTO BODY, UNTIL CONTACT IS FULLY LOCATED BY AN AUDIBLE CLICK.
2. ENSURE THAT KNURLED HOUSING INSERTS BETWEEN THE DIELECTRIC AND CABLE BRAID.

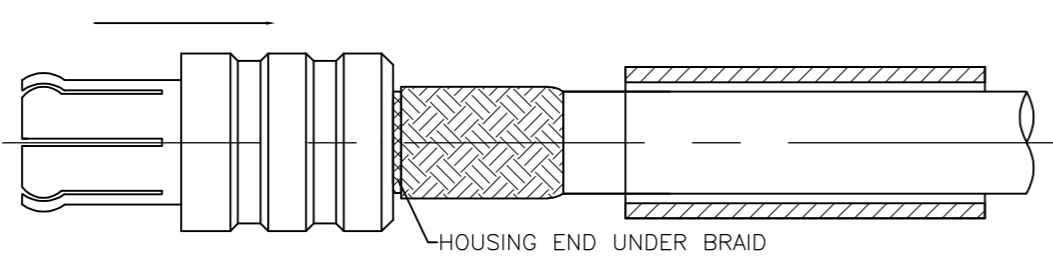

STEP 5

1. SLIDE CRIMP FERRULE ALONG THE CABLE UNTIL IT BUTTS AGAINST THE HOUSING BODY.
2. CRIMP SLEEVE USING TOOL AS NOTED ON PAGE 1 NOTE 4
3. CRIMP DIMENSION AS SHOWN

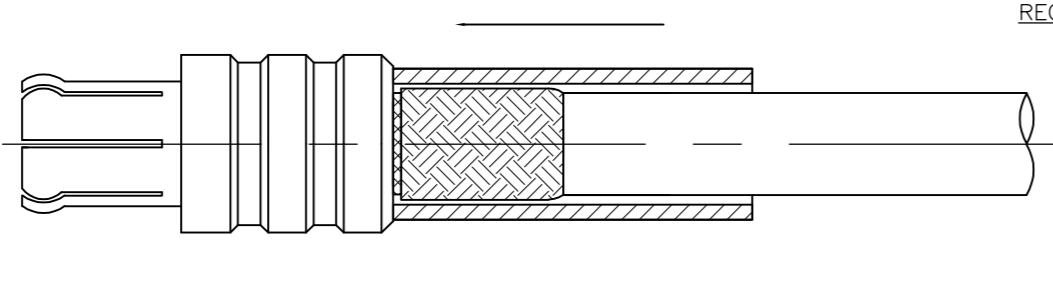

THIS DRAWING IS A CONTROLLED DOCUMENT.

DWN JSANDWELL 09NOV04	 Tyco Electronics Corporation Bideford, EX39 4HE	NAME	MCX STRAIGHT PLUG CRIMP 50 OHMS RG174, 188, 316, URM95, KX3B, 22A
CHK S.PARLOW 09NOV04		SIZE	A2
APVD F.WHEELER-KING 09NOV04		CAGE CODE	00779
PRODUCT SPEC		DRAWING NO	C=1337580
APPLICATION SPEC	RESTRICTED TO		
WEIGHT	SCALE	NTS	SHEET 2 OF 2
CUSTOMER DRAWING	REV	E	

1337580