



Chipsmall Limited consists of a professional team with an average of over 10 year of expertise in the distribution of electronic components. Based in Hongkong, we have already established firm and mutual-benefit business relationships with customers from,Europe,America and south Asia,supplying obsolete and hard-to-find components to meet their specific needs.

With the principle of “Quality Parts,Customers Priority,Honest Operation,and Considerate Service”,our business mainly focus on the distribution of electronic components. Line cards we deal with include Microchip,ALPS,ROHM,Xilinx,Pulse,ON,Everlight and Freescale. Main products comprise IC,Modules,Potentiometer,IC Socket,Relay,Connector.Our parts cover such applications as commercial,industrial, and automotives areas.

We are looking forward to setting up business relationship with you and hope to provide you with the best service and solution. Let us make a better world for our industry!



Contact us

Tel: +86-755-8981 8866 Fax: +86-755-8427 6832

Email & Skype: info@chipsmall.com Web: www.chipsmall.com

Address: A1208, Overseas Decoration Building, #122 Zhenhua RD., Futian, Shenzhen, China



V23552-C1***-B101 : Übergabebrücke vorbestückt, 1SU-Steckplätze/
 V23552-C1***-B101 : Adapter bridge pre-equipped, 1SU plug-in locations

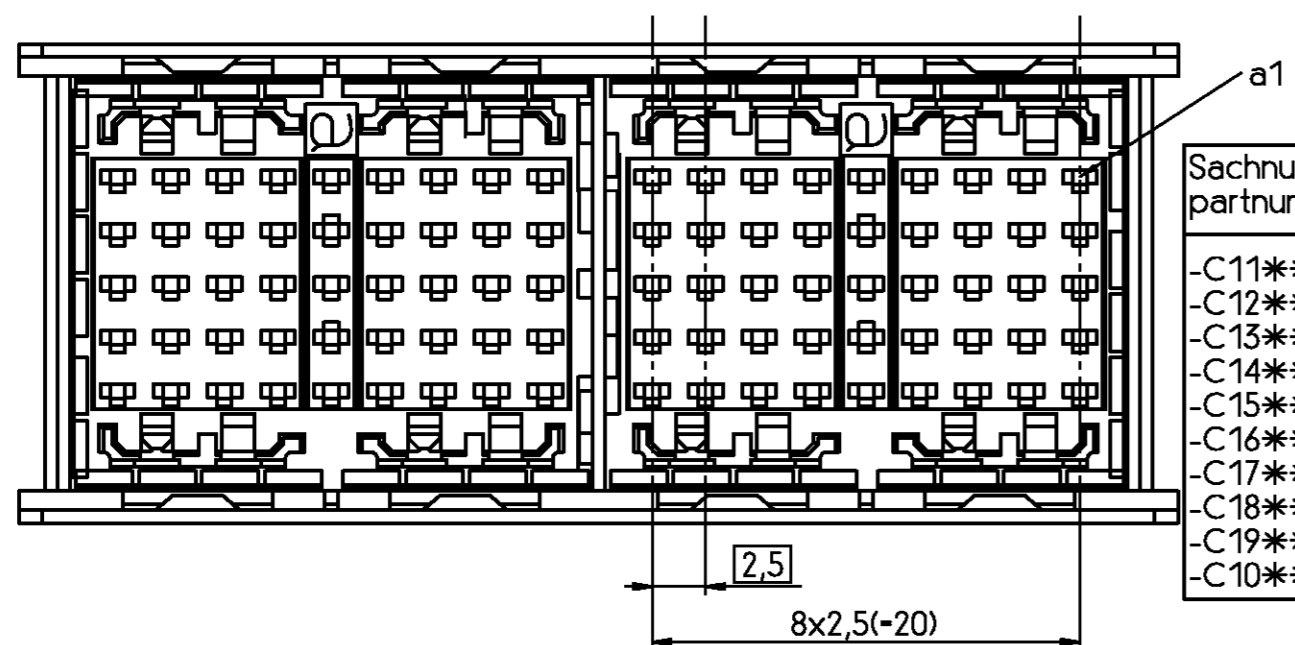
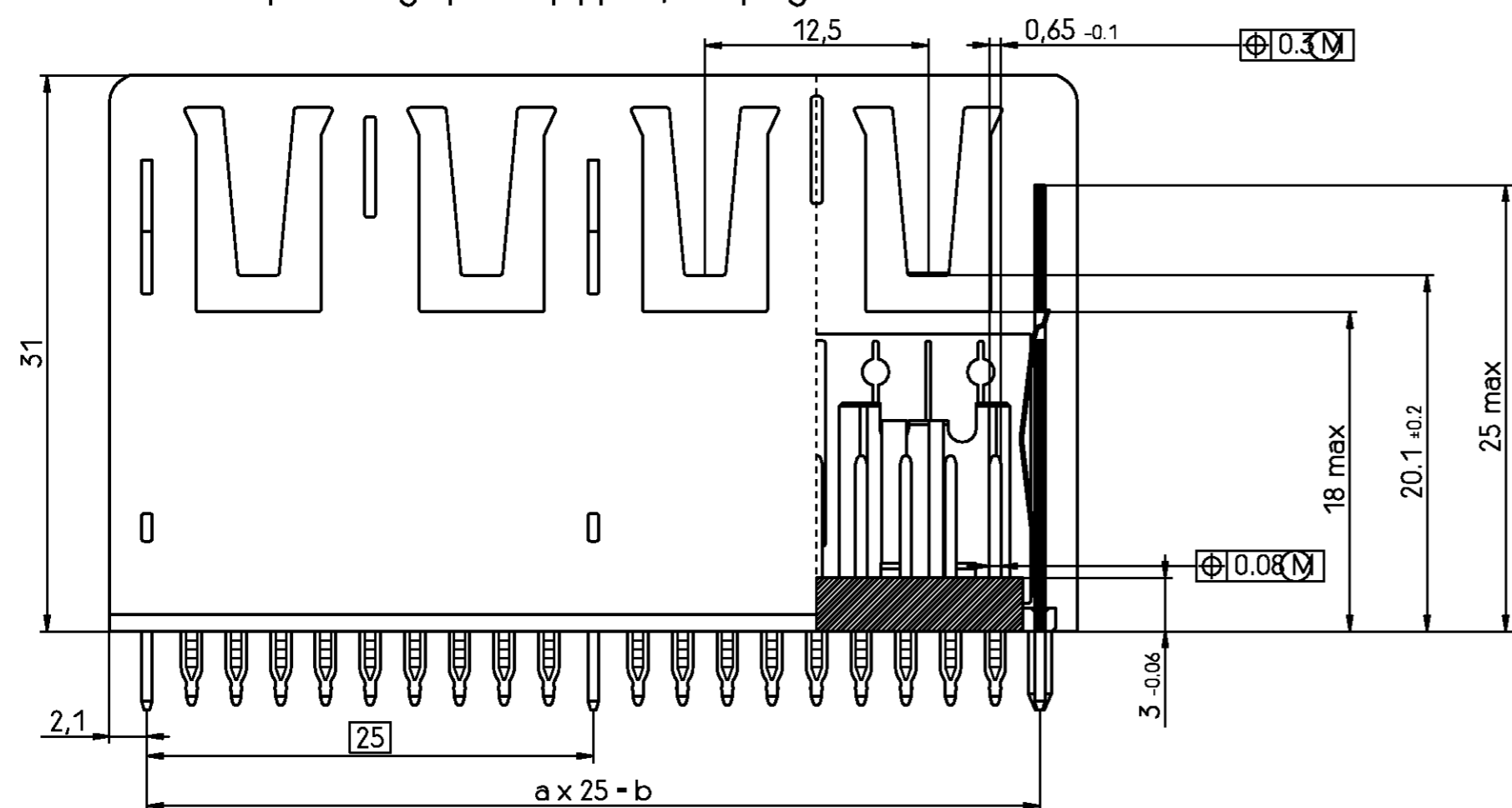

Sachnummer/ partnumber	a x 25 = b
-C11***-B101	1 x 25 = 25
-C12***-B101	2 x 25 = 50
-C13***-B101	3 x 25 = 75
-C14***-B101	4 x 25 = 100
-C15***-B101	5 x 25 = 125
-C16***-B101	6 x 25 = 150
-C17***-B101	7 x 25 = 175
-C18***-B101	8 x 25 = 200
-C19***-B101	9 x 25 = 225
-C10***-B101	10 x 25 = 250

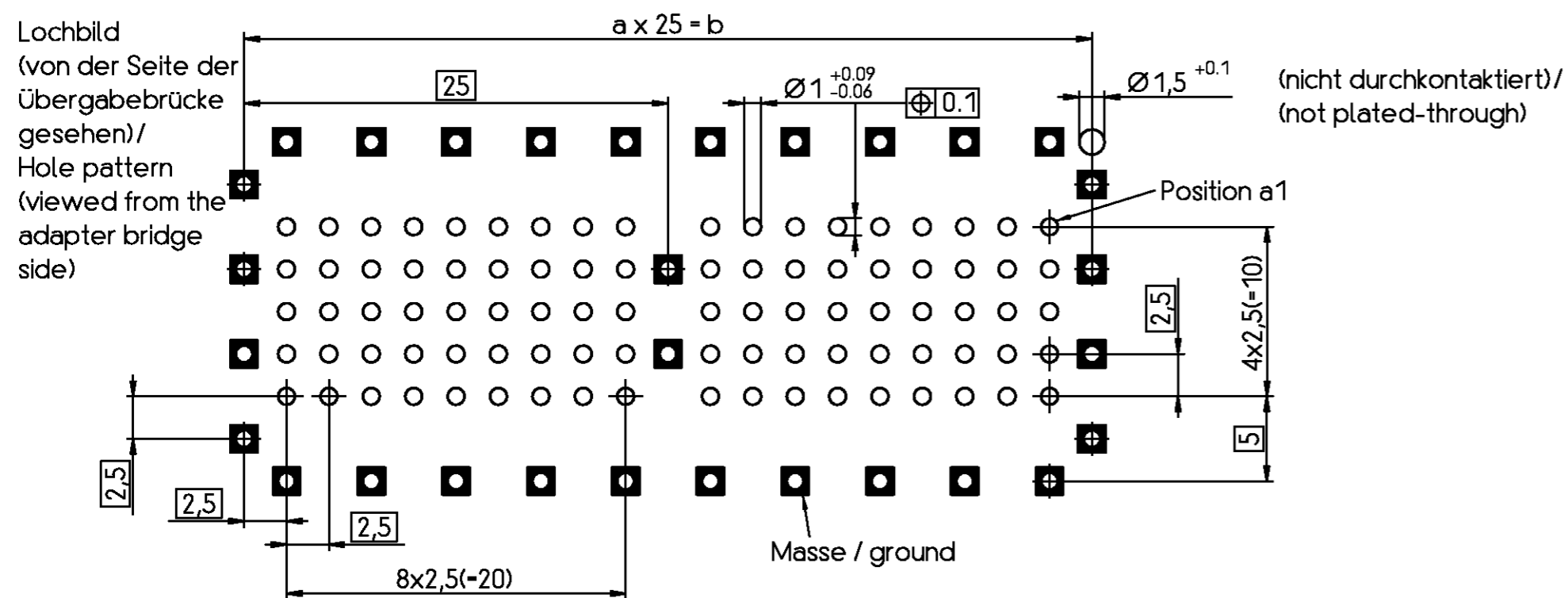

V23552-C1***-A101 : Übergabebrücke vorbestückt, 1/2SU-Steckplätze/
 V23552-C1***-A101 : Adapter bridge pre-equipped, 1/2SU plug-in locations

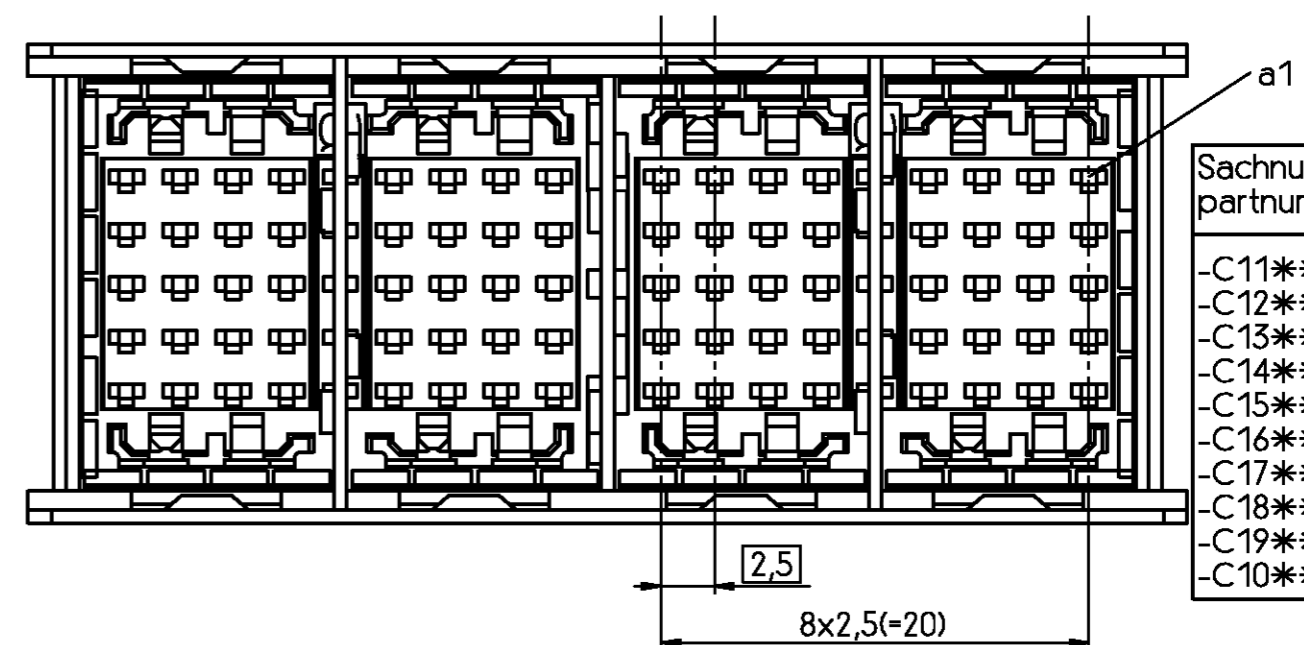
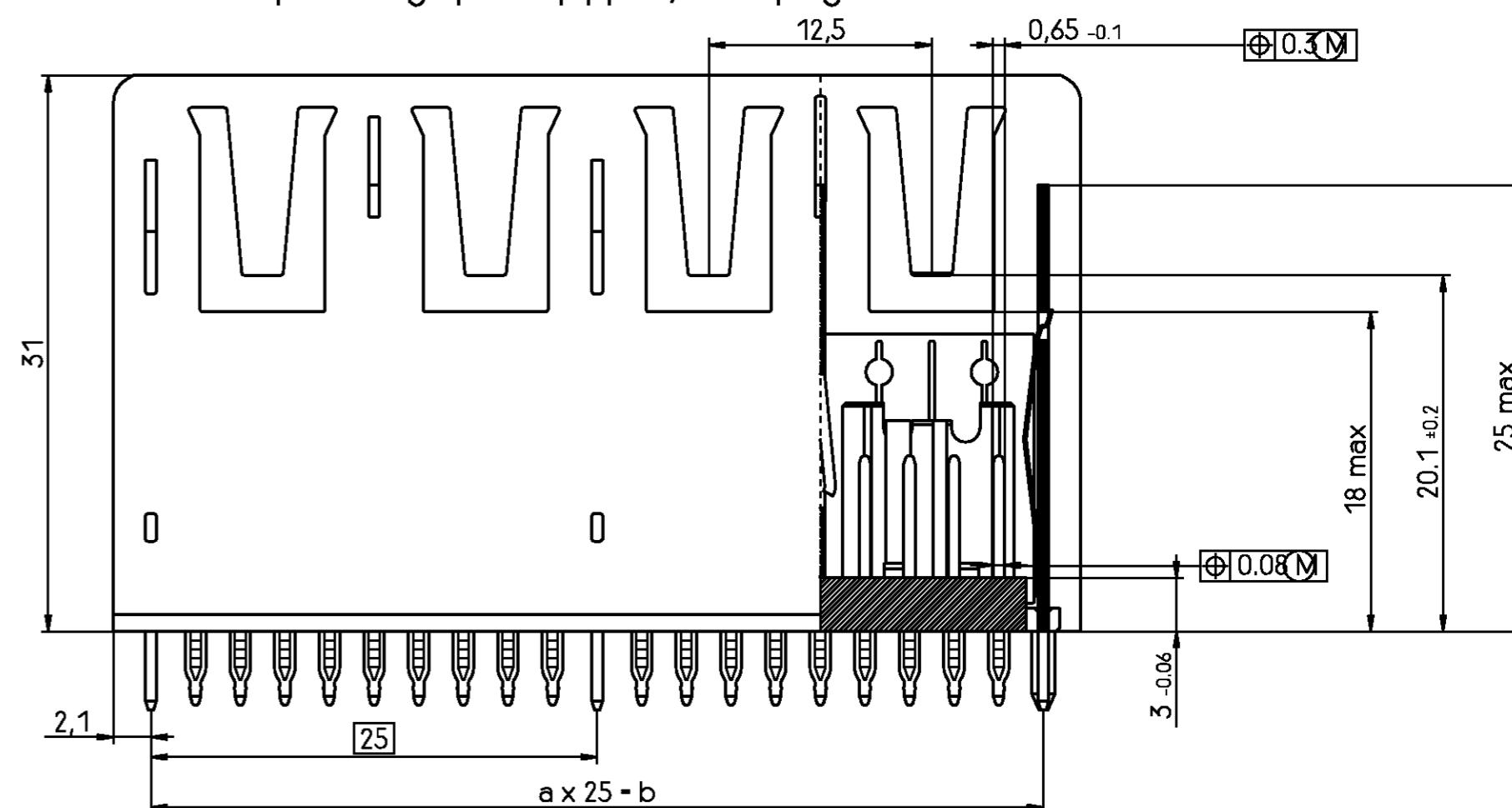

Sachnummer/ partnumber	a x 25 = b
-C11***-A101	1 x 25 = 25
-C12***-A101	2 x 25 = 50
-C13***-A101	3 x 25 = 75
-C14***-A101	4 x 25 = 100
-C15***-A101	5 x 25 = 125
-C16***-A101	6 x 25 = 150
-C17***-A101	7 x 25 = 175
-C18***-A101	8 x 25 = 200
-C19***-A101	9 x 25 = 225
-C10***-A101	10 x 25 = 250

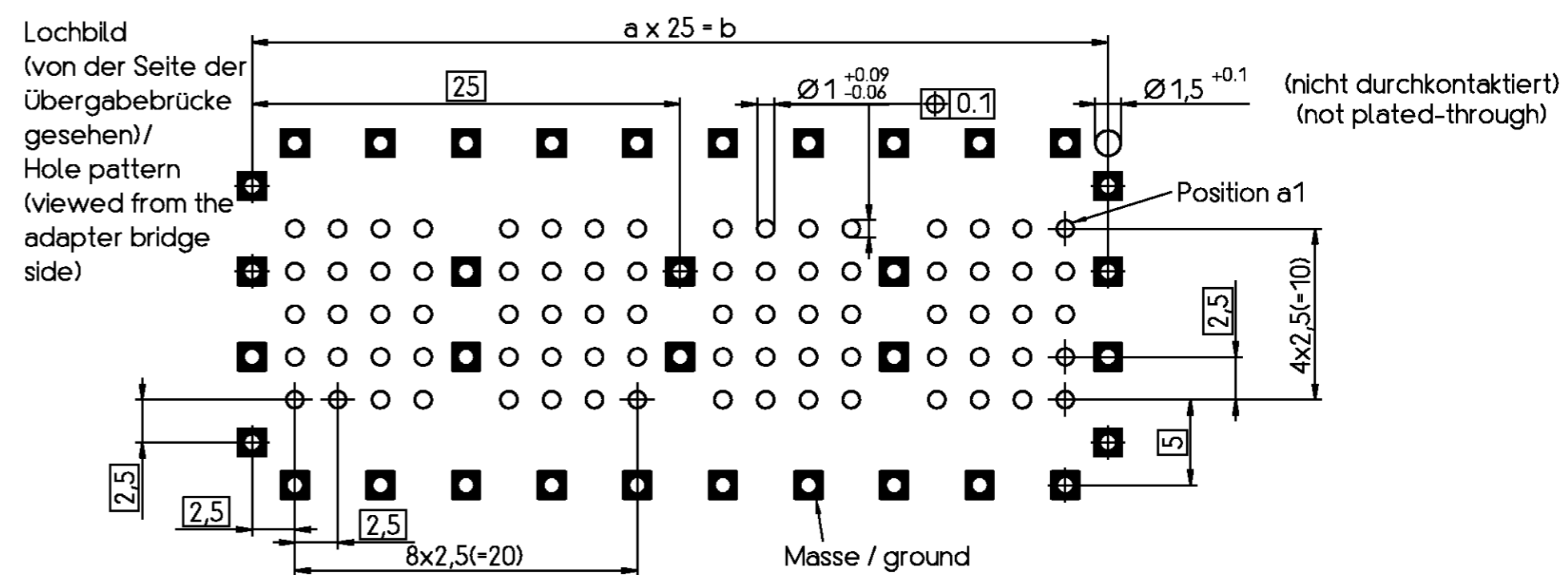

THIS INFORMATION IS CONFIDENTIAL AND PROPRIETARY TO TYCO ELECTRONICS CORPORATION AND ITS WORLDWIDE SUBSIDIARIES AND AFFILIATES. IT MAY NOT BE DISCLOSED TO ANYONE, OTHER THAN TYCO ELECTRONICS PERSONEL, WITHOUT WRITTEN AUTHORIZATION FROM TYCO ELECTRONICS CORPORATION, HARRISBURG PENNSYLVANIA USA.

TE TE Connectivity		SCALE 2:1	WEIGHT
LOC DIMENSIONS IN MM		MATERIAL	
DATE	16.06.00	PART NAME	
NAME	Vanbesien	Techn-Lieferverpfl	
APP.	COM PD	Eng oblig for deliv	
TOLERANCE UNLESS SPECIFIED OTHERWISE		PART NO.	SHT. 1+
B3	ECO-12-013600 02NOV12 MH	V23552-C1***-+10*-*-7426	OF 3
REV.	CHANGE ORDER	DATE	APP.
Customer Drawing Nr C 13923718-3			

V23552-C1***-B101 : Übergabebrücke vorbestückt (Schachbrett), 1SU-Steckplätze/
 V23552-C1***-B101 : Adapter bridge pre-equipped (Chessboard), 1SU plug-in locations

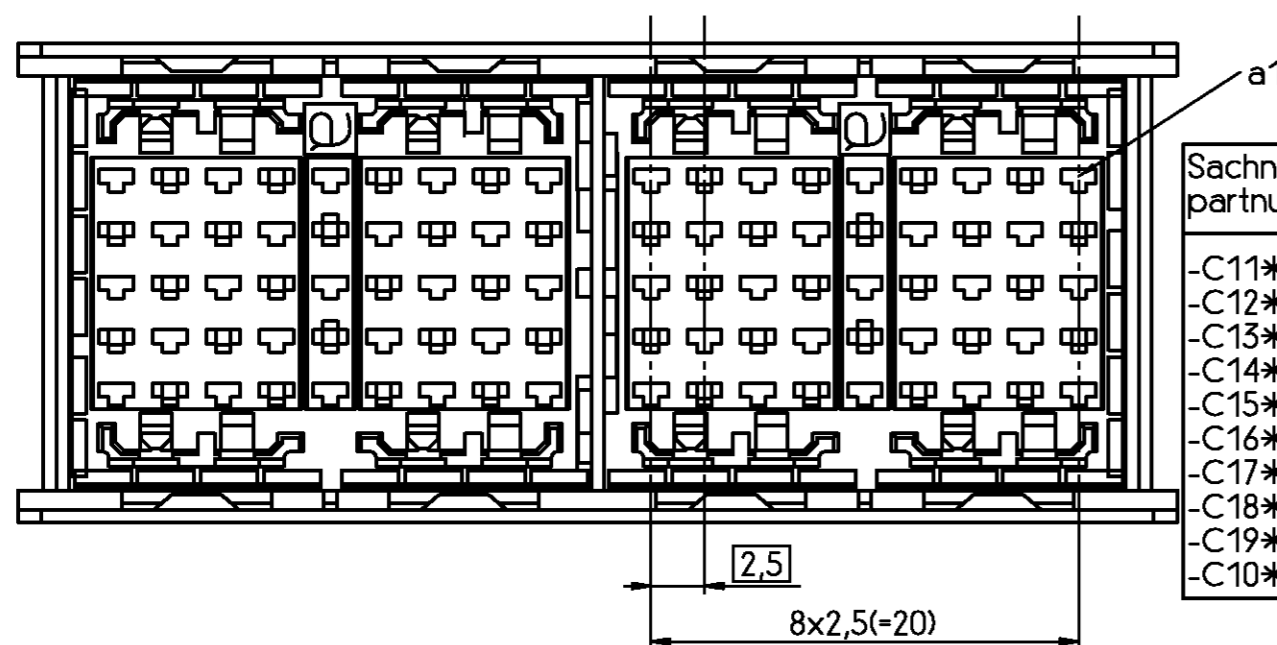
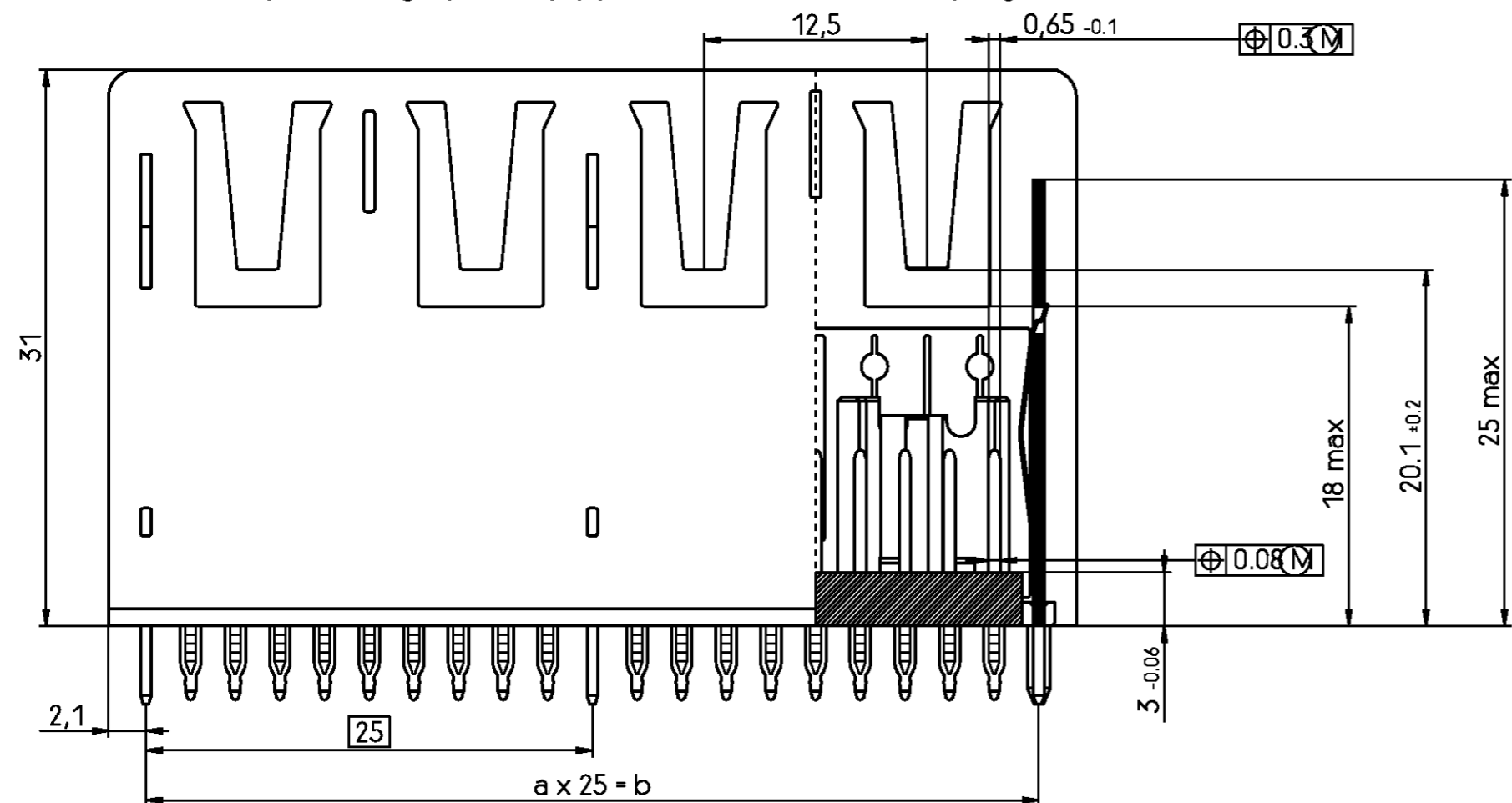

Sachnummer/ partnumber	a x 25 = b
-C11***-B102	1 x 25 = 25
-C12***-B102	2 x 25 = 50
-C13***-B102	3 x 25 = 75
-C14***-B102	4 x 25 = 100
-C15***-B102	5 x 25 = 125
-C16***-B102	6 x 25 = 150
-C17***-B102	7 x 25 = 175
-C18***-B102	8 x 25 = 200
-C19***-B102	9 x 25 = 225
-C10***-B102	10 x 25 = 250

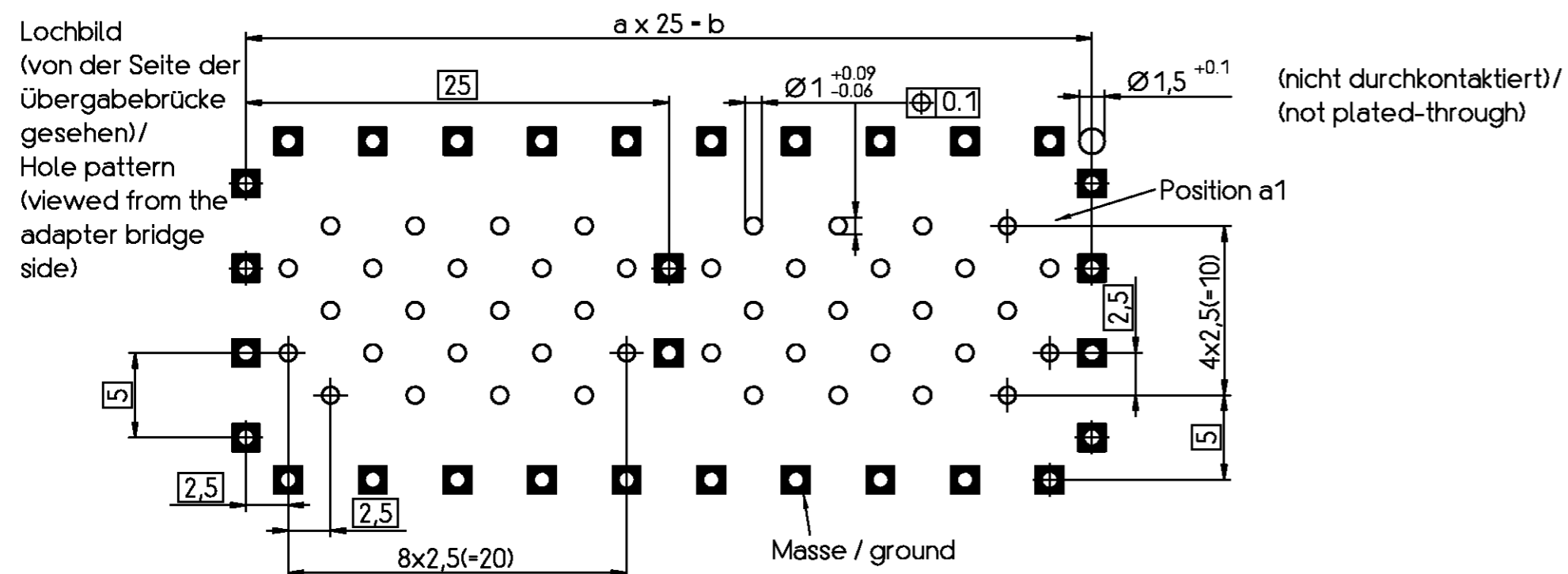

V23552-C1***-A101 : Übergabebrücke vorbestückt (Schachbrett), 1/2SU-Steckplätze/
 V23552-C1***-A101 : Adapter bridge pre-equipped (Chessboard), 1/2SU plug-in locations

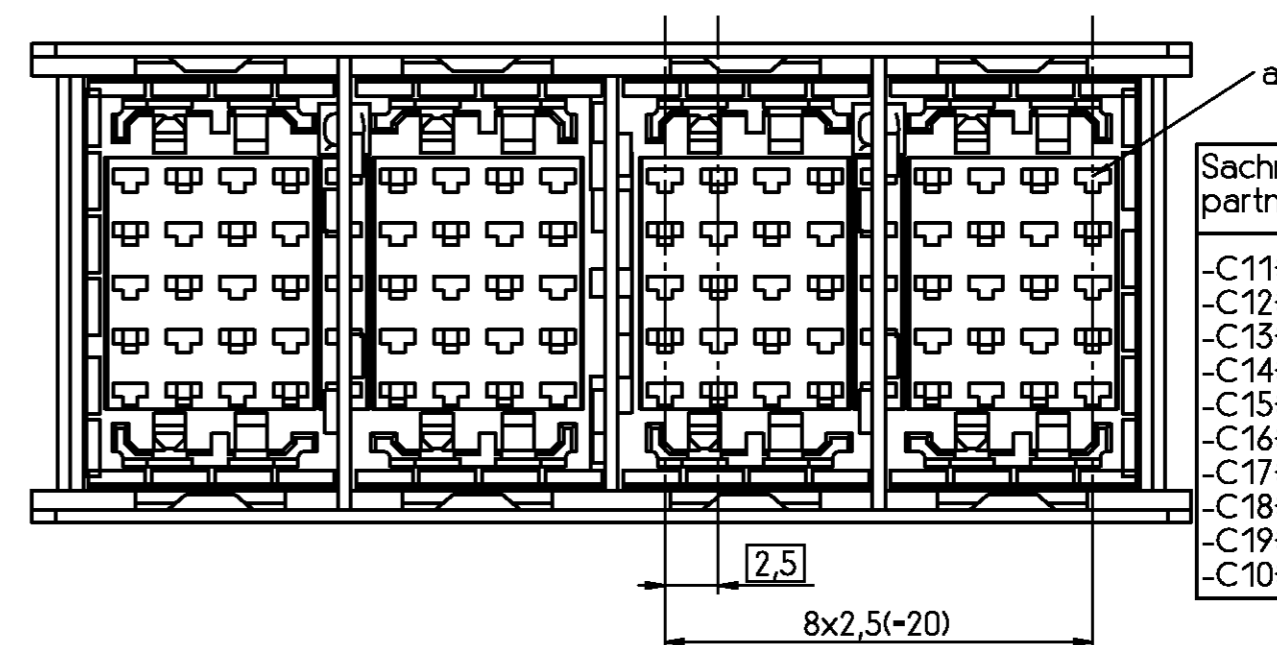
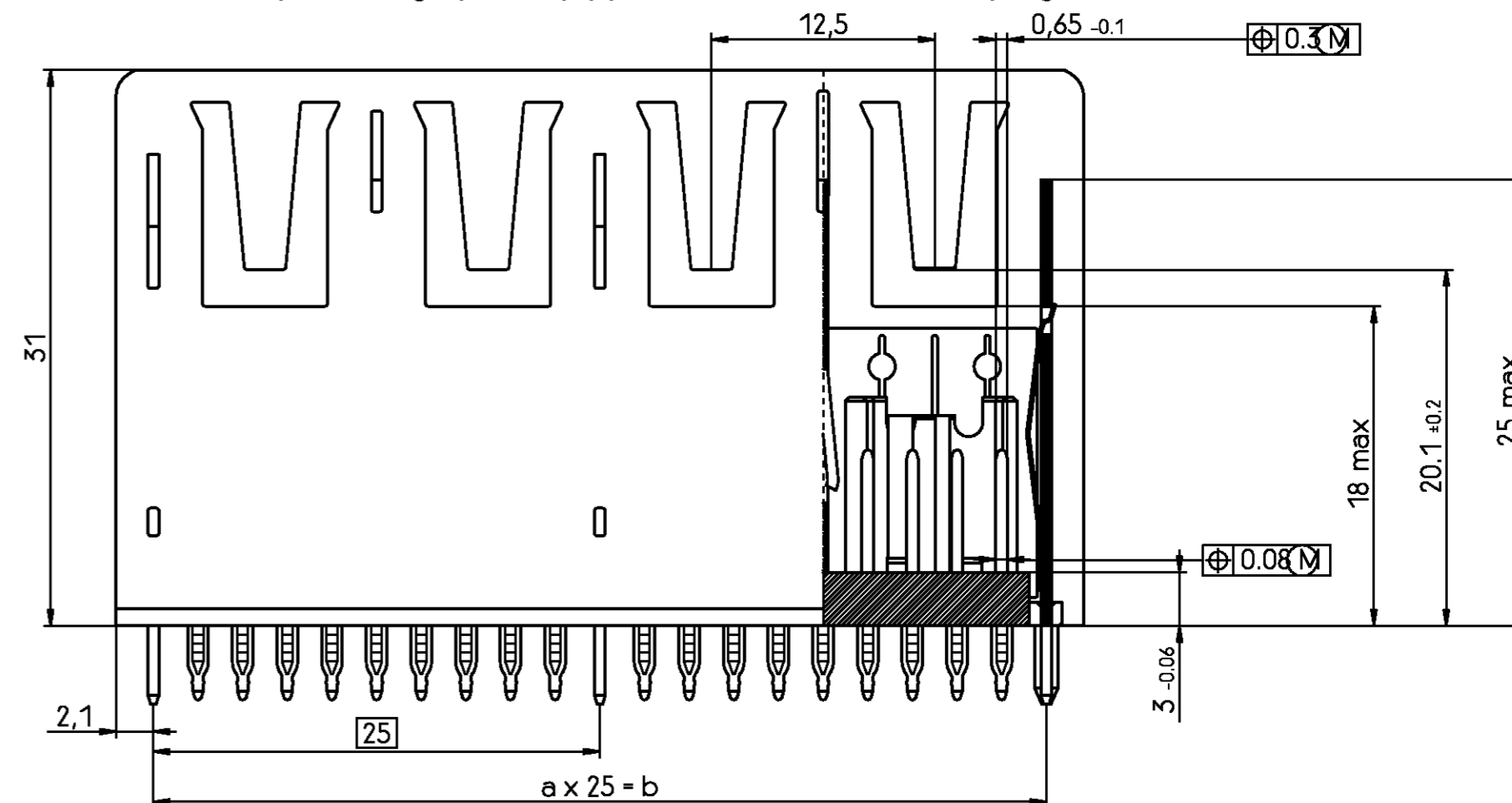

Sachnummer/ partnumber	a x 25 = b
-C11***-A102	1 x 25 = 25
-C12***-A102	2 x 25 = 50
-C13***-A102	3 x 25 = 75
-C14***-A102	4 x 25 = 100
-C15***-A102	5 x 25 = 125
-C16***-A102	6 x 25 = 150
-C17***-A102	7 x 25 = 175
-C18***-A102	8 x 25 = 200
-C19***-A102	9 x 25 = 225
-C10***-A102	10 x 25 = 250

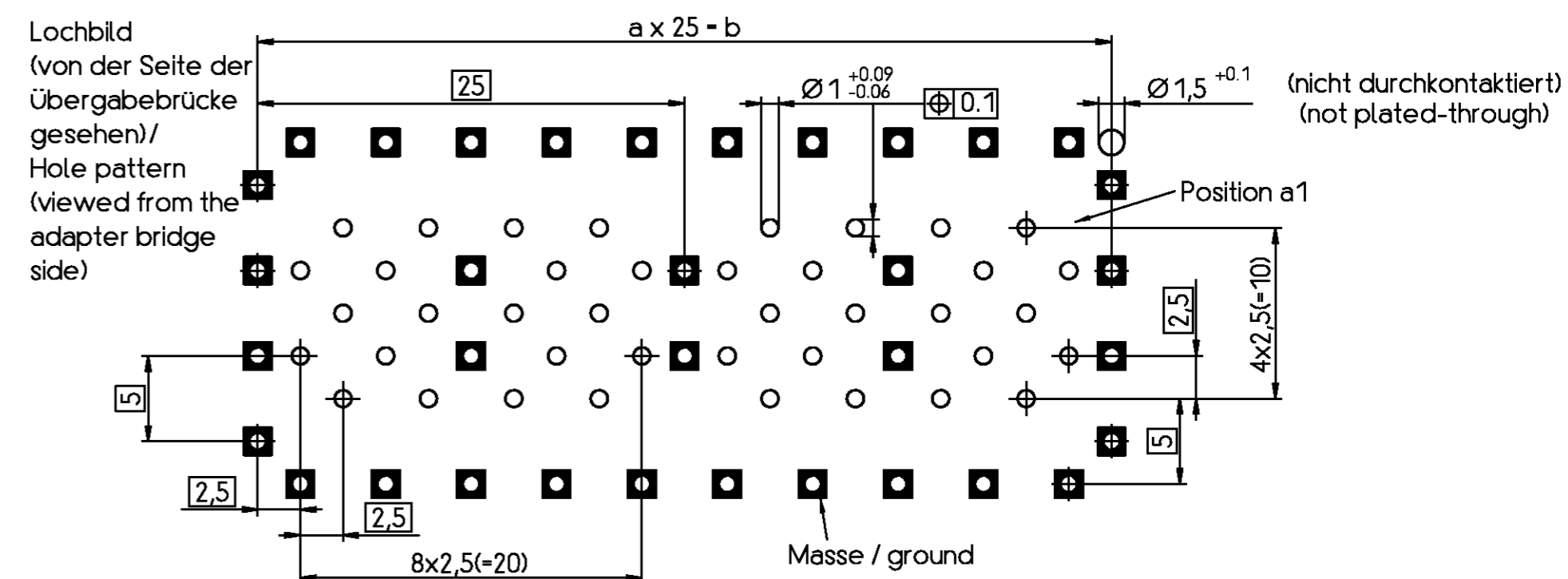

THIS INFORMATION IS CONFIDENTIAL AND PROPRIETARY TO TYCO ELECTRONICS CORPORATION AND ITS WORLDWIDE SUBSIDIARIES AND AFFILIATES. IT MAY NOT BE DISCLOSED TO ANYONE, OTHER THAN TYCO ELECTRONICS PERSONEL, WITHOUT WRITTEN AUTHORIZATION FROM TYCO ELECTRONICS CORPORATION, HARRISBURG PENNSYLVANIA USA.

TE TE Connectivity

SCALE 2:1 WEIGHT

MATERIAL

LOC DIMENSIONS IN MM

DATE 16.06.00

NAME Vanbesien

APP. COM PD

PART NAME

Techn-Lieferverpfl

Eng oblig for deliv

TOLERANCE UNLESS SPECIFIED OTHERWISE

PART NO. V23552-C1***-+10*-*-7426

SEE SHEET 1

REV. CHANGE ORDER DATE APP. Customer Drawing Nr. C.1393718-3

SFT. 2-

OF 3

THIS INFORMATION IS CONFIDENTIAL AND PROPRIETARY TO TYCO ELECTRONICS CORPORATION AND ITS WORLDWIDE SUBSIDIARIES AND AFFILIATES. IT MAY NOT BE DISCLOSED TO ANYONE, OTHER THAN TYCO ELECTRONICS PERSONNEL, WITHOUT WRITTEN AUTHORIZATION FROM TYCO ELECTRONICS CORPORATION, HARRISBURG PENNSYLVANIA USA

PROPRIETARY:

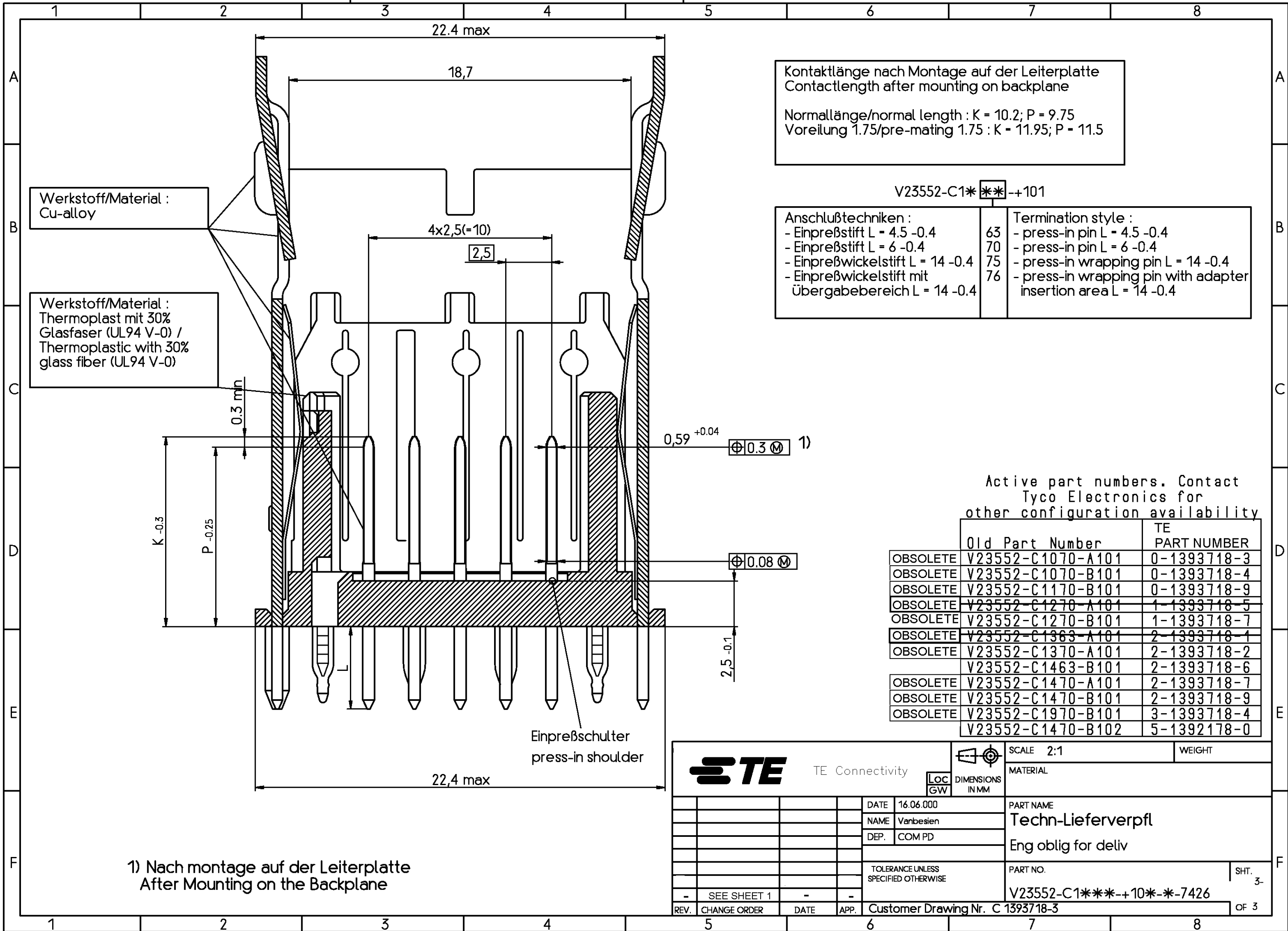

Kontaklänge nach Montage auf der Leiterplatte
 Contactlength after mounting on backplane
 Normallänge/normal length : K = 10.2; P = 9.75
 Voreilung 1.75/pre-mating 1.75 : K = 11.95; P = 11.5

V23552-C1***+101

Anschlußtechniken :	Termination style :
- Einpreßstift L = 4.5 -0.4	63 - press-in pin L = 4.5 -0.4
- Einpreßstift L = 6 -0.4	70 - press-in pin L = 6 -0.4
- Einpreßwickelstift L = 14 -0.4	75 - press-in wrapping pin L = 14 -0.4
- Einpreßwickelstift mit Übergabebereich L = 14 -0.4	76 - press-in wrapping pin with adapter insertion area L = 14 -0.4

Werkstoff/Material :
Cu-alloy

Werkstoff/Material :
Thermoplast mit 30%
Glasfaser (UL94 V-0) /
Thermoplastic with 30%
glass fiber (UL94 V-0)

Active part numbers. Contact Tyco Electronics for other configuration availability

	Old Part Number	TE PART NUMBER
OBSOLETE	V23552-C1070-A101	0-1393718-3
OBSOLETE	V23552-C1070-B101	0-1393718-4
OBSOLETE	V23552-C1170-B101	0-1393718-9
OBSOLETE	V23552-C1270-A101	1-1393718-5
OBSOLETE	V23552-C1270-B101	1-1393718-7
OBSOLETE	V23552-C1363-A101	2-1393718-1
OBSOLETE	V23552-C1370-A101	2-1393718-2
	V23552-C1463-B101	2-1393718-6
OBSOLETE	V23552-C1470-A101	2-1393718-7
OBSOLETE	V23552-C1470-B101	2-1393718-9
OBSOLETE	V23552-C1970-B101	3-1393718-4
	V23552-C1470-B102	5-1392178-0

TE TE Connectivity		SCALE 2:1	WEIGHT
DIMENSIONS IN MM		MATERIAL	
DATE	16.06.000	PART NAME	
NAME	Vanbesien	Techn-Lieferverpfl	
DEP.	COM PD	Eng oblig for deliv	
TOLERANCE UNLESS SPECIFIED OTHERWISE		PART NO.	SHT. 3-
SEE SHEET 1		V23552-C1***+10*-*-7426	OF 3
REV.	CHANGE ORDER	DATE	APP.
Customer Drawing Nr. C 1393718-3			

1) Nach montage auf der Leiterplatte
After Mounting on the Backplane