



Chipsmall Limited consists of a professional team with an average of over 10 year of expertise in the distribution of electronic components. Based in Hongkong, we have already established firm and mutual-benefit business relationships with customers from,Europe,America and south Asia,supplying obsolete and hard-to-find components to meet their specific needs.

With the principle of “Quality Parts,Customers Priority,Honest Operation,and Considerate Service”,our business mainly focus on the distribution of electronic components. Line cards we deal with include Microchip,ALPS,ROHM,Xilinx,Pulse,ON,Everlight and Freescale. Main products comprise IC,Modules,Potentiometer,IC Socket,Relay,Connector.Our parts cover such applications as commercial,industrial, and automotives areas.

We are looking forward to setting up business relationship with you and hope to provide you with the best service and solution. Let us make a better world for our industry!



Contact us

Tel: +86-755-8981 8866 Fax: +86-755-8427 6832

Email & Skype: info@chipsmall.com Web: www.chipsmall.com

Address: A1208, Overseas Decoration Building, #122 Zhenhua RD., Futian, Shenzhen, China



REVISIONS				
P	LTR	DESCRIPTION	DATE	APVD
E2		REVISED PER ECO-15-014756	13OCT2015	DD JS

LEVER IN PRE-STAGE POSITION

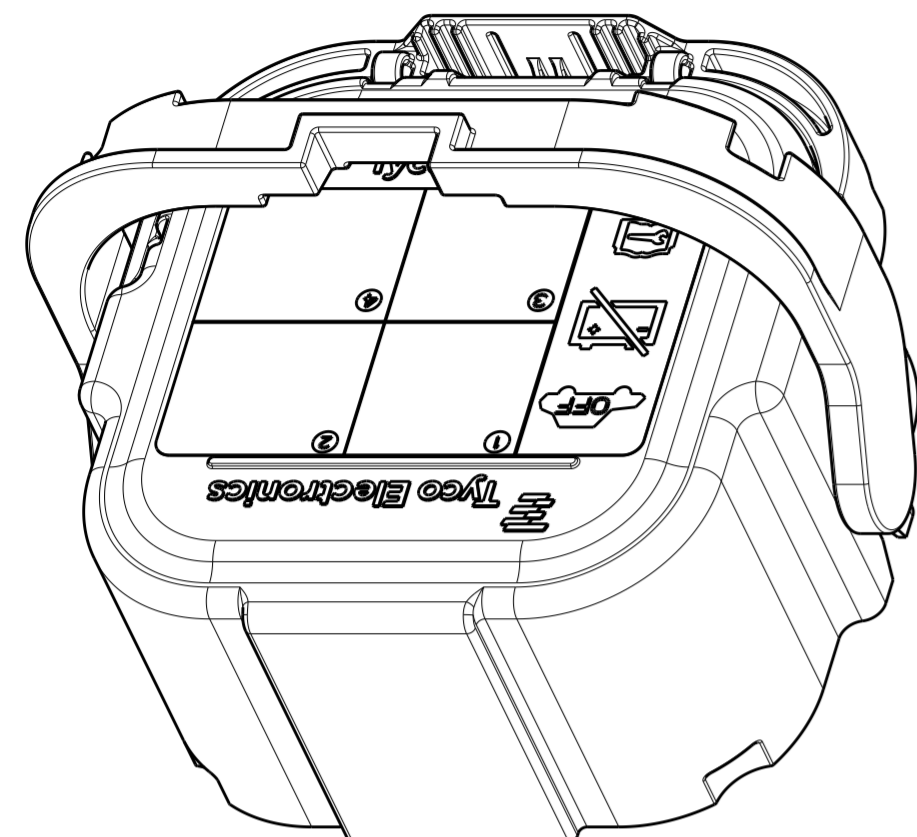

ISOMETRIC VIEW
SCALE 1:1

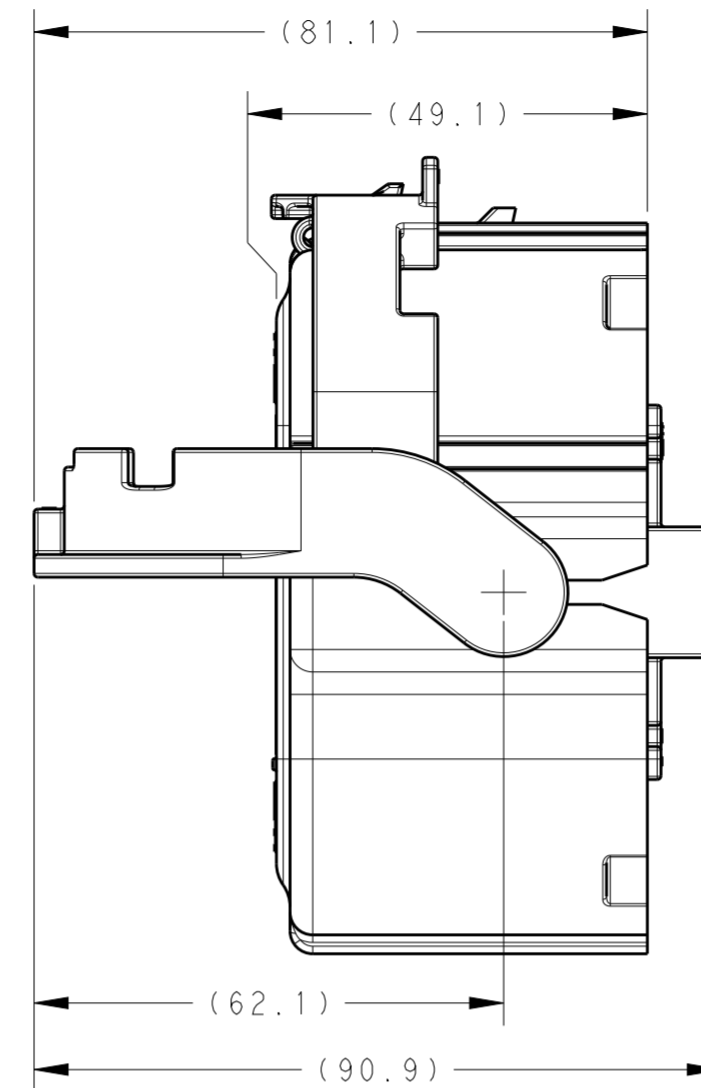
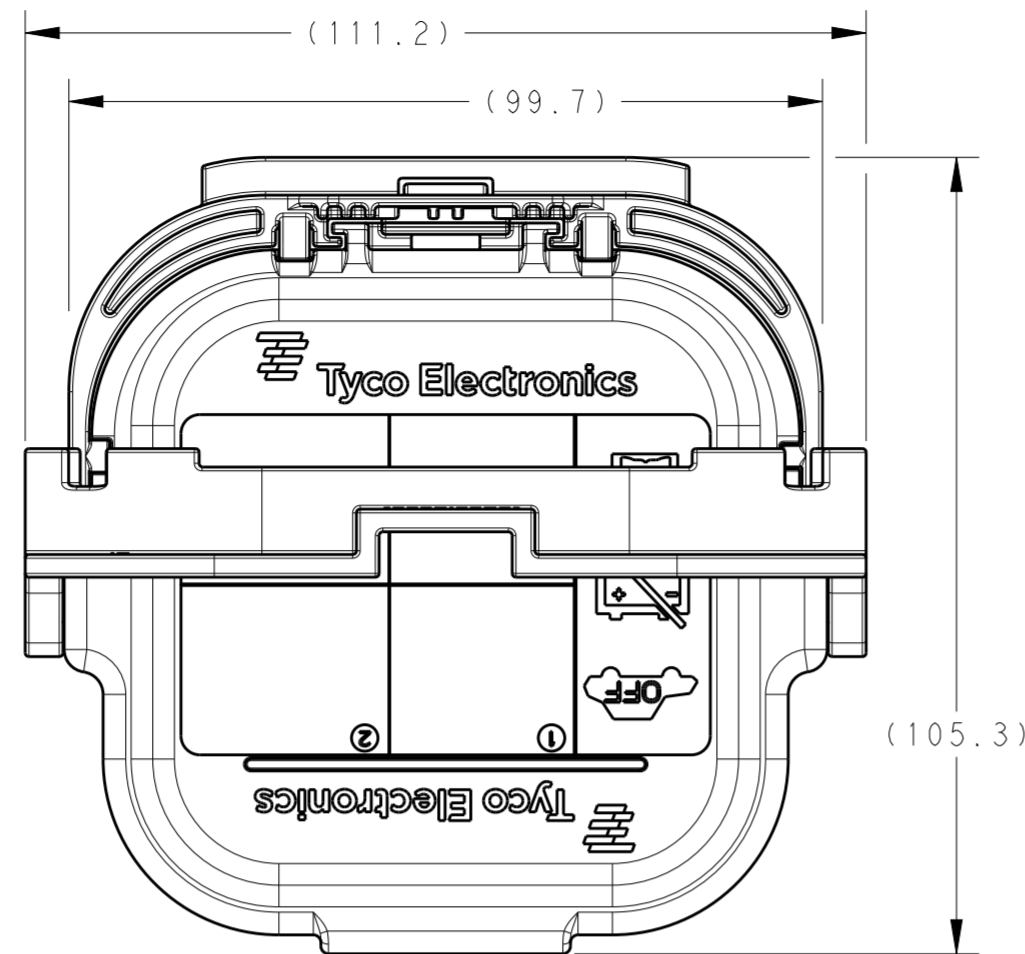

LEVER IN LOCKED POSITION

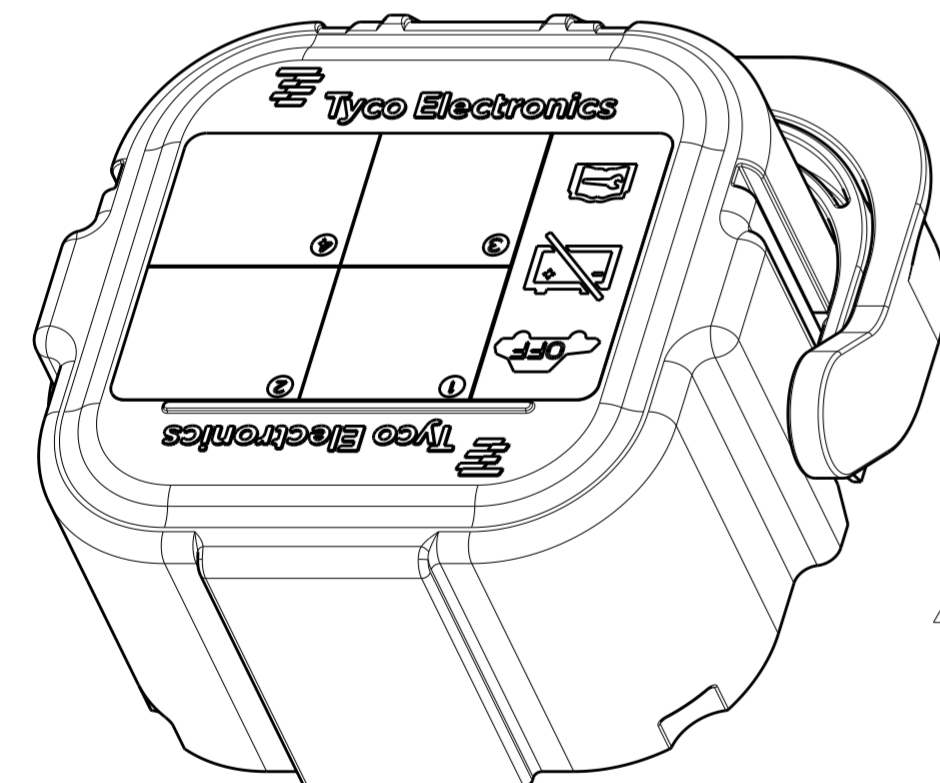

ISOMETRIC VIEW
SCALE 1:1

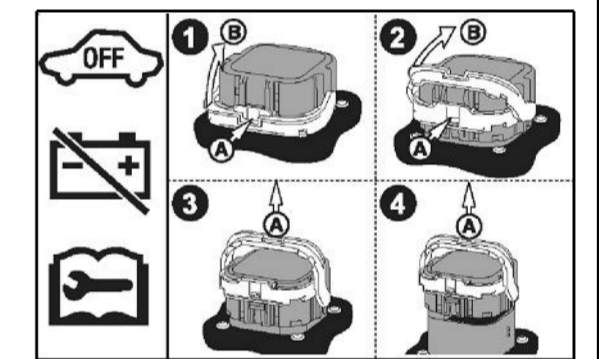
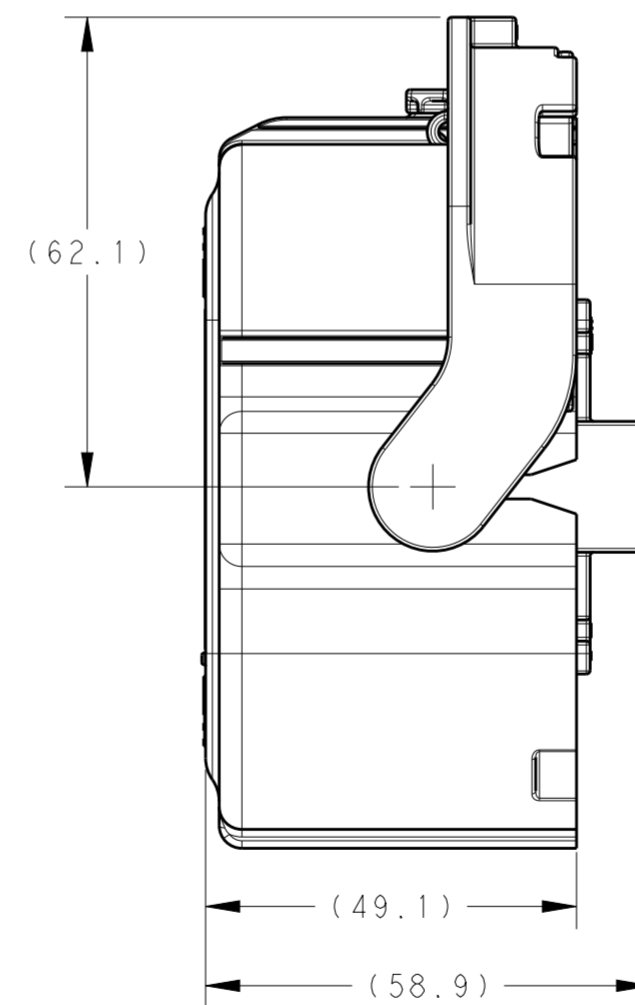
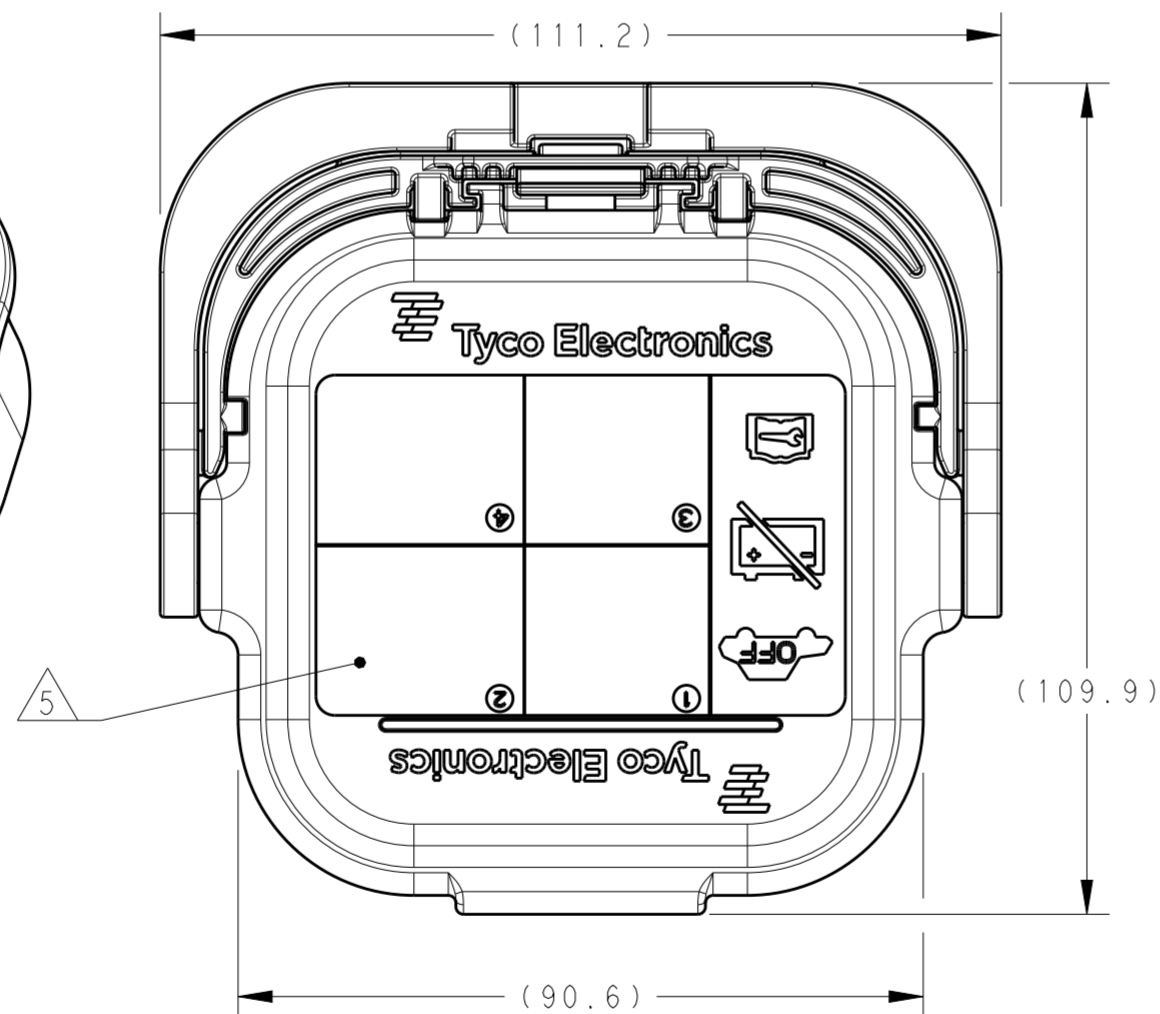

- ① INNER HOUSING MAY BE ASSEMBLED ROTATED 180° FROM AS SHOWN.
- ② ASSEMBLY / WORK INSTRUCTIONS: 408-10432
PRODUCT SPECIFICATION: 108-127000
APPLICATION SPECIFICATION: 501-127000
- ③ NOTE DELETED.
- ④ SEE TABLE AND SHEET 2 FOR FUSE RATINGS AND KEYING.
- ⑤ IMAGE FOR REFERENCE ONLY, SHOWS LABEL ORIENTATION.
- ⑥ ACTUAL APPEARANCE OF LABEL.

NATURAL/OFF-WHITE	261.25	SHUNT	2-2103212-7
NATURAL/OFF-WHITE	525.60	350A (EV)	2-2103212-2
BLACK	525.60	350A (EV)	2-2103212-1
NATURAL/OFF-WHITE	525.60	250A (EV)	1-2103212-9
NATURAL/OFF-WHITE	525.60	200A (EV)	1-2103212-8
BLACK	261.25	SHUNT	1-2103212-7
BLACK	525.60	350A	1-2103212-2
NATURAL/OFF-WHITE	525.60	350A	1-2103212-1
BLACK	525.60	250A	2103212-9
BLACK	525.60	200A	2103212-8
INNER LEVER COLOR	PART WEIGHT (g)	FUSE RATING	PART NO.

DIMENSIONS:		TOLERANCES UNLESS OTHERWISE SPECIFIED:	
mm			
0 PLC	±		
1 PLC	±		
2 PLC	±		
3 PLC	±		
4 PLC	±		
ANGLES	±		
FINISH			

DWN	A BOYER	14JUL2011
CHK	A BOYER	14JUL2011
APVD	A GUANCO	14JUL2011
PRODUCT SPEC		②
APPLICATION SPEC		②
WEIGHT	SEE TABLE	
CUSTOMER DRAWING		

STE TE Connectivity			
PLUG ASSEMBLY MANUAL SERVICE DISCONNECT			
SIZE	CAGE CODE	DRAWING NO	RESTRICTED TO
A200779	C-2103212		
SCALE	1:1	SHEET	1 OF 2
REV	E2		

REVISIONS				
P	LTR	DESCRIPTION	DATE	APVD
-	-	SEE SHEET 1	-	-

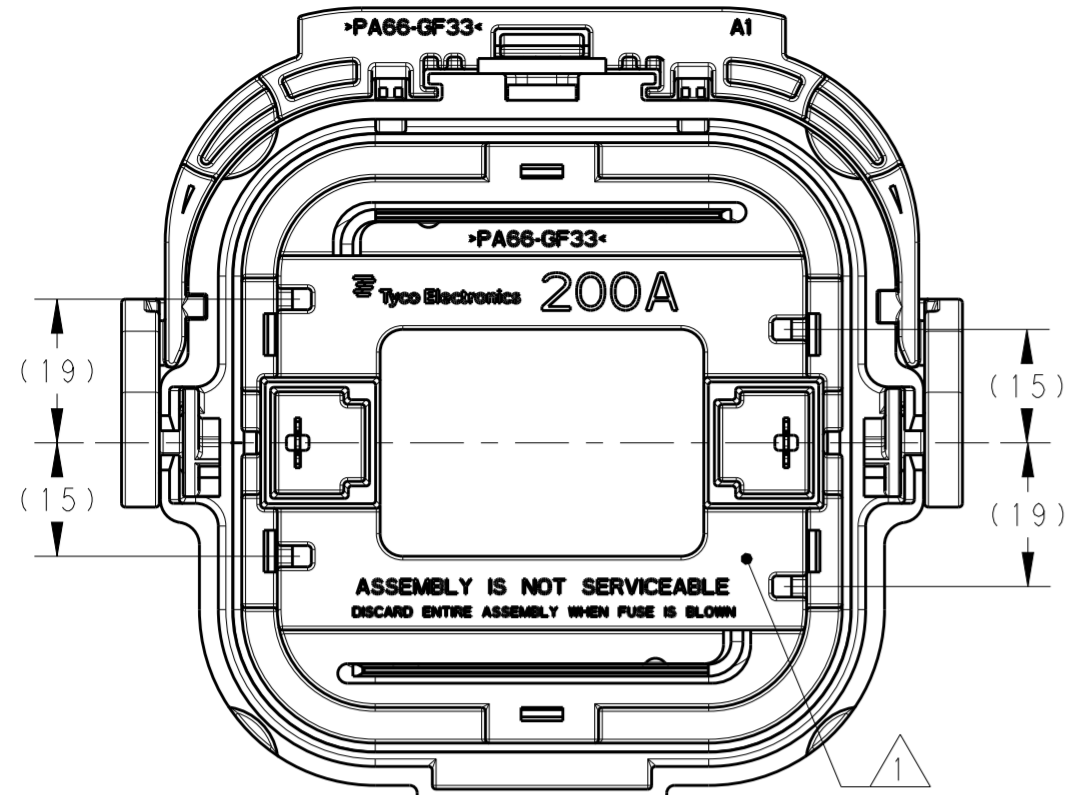

2103212-8 & 1-2103212-8
 FUSE RATING: 200A

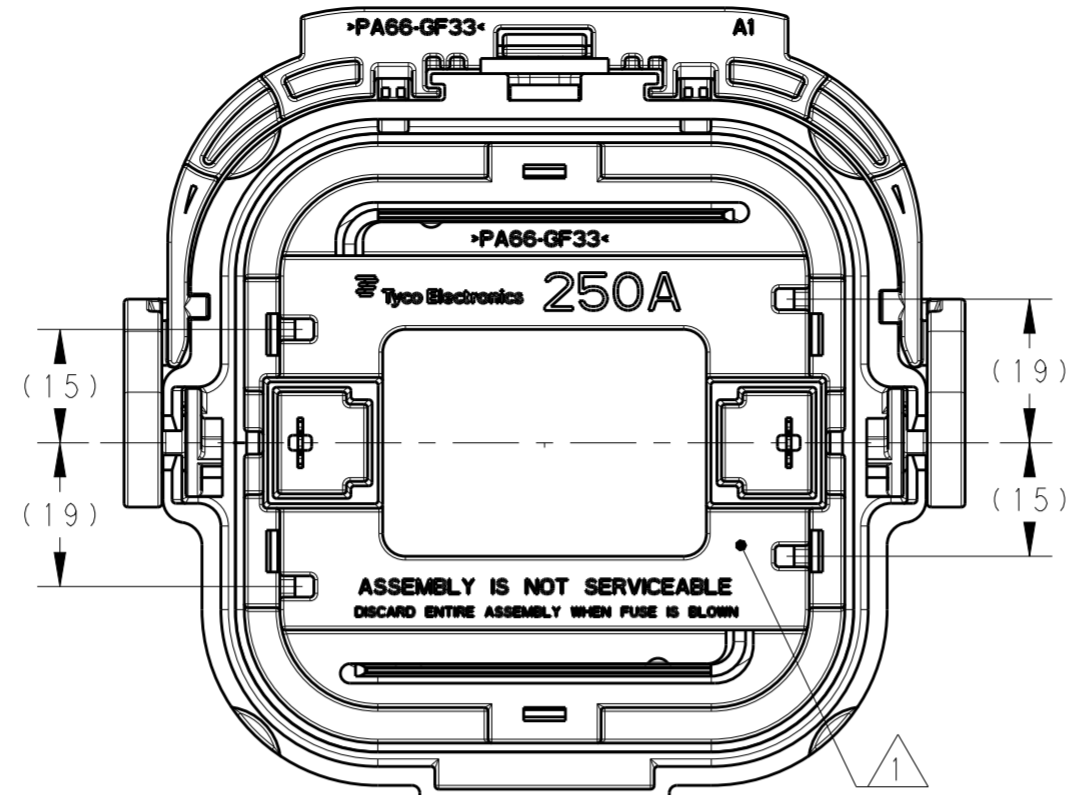

2103212-9 & 1-2103212-9
 FUSE RATING: 250A

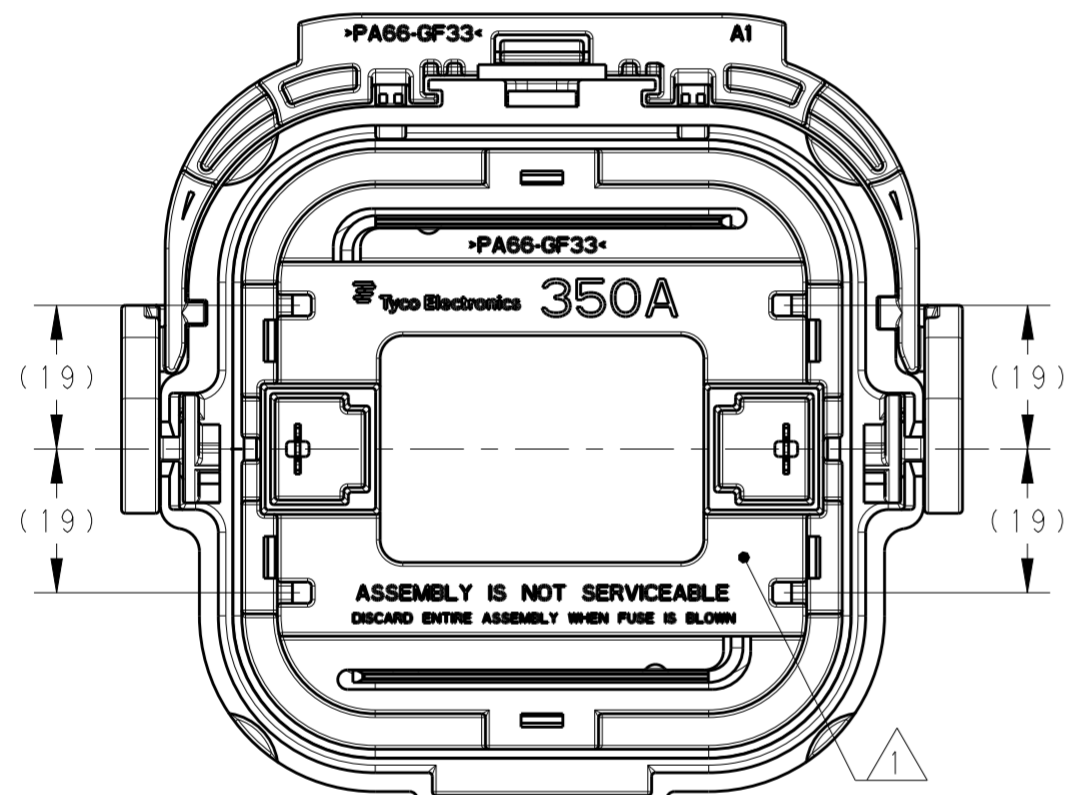

1-2103212-1, 1-2103212-2, 2-2103212-1
 & 2-2103212-2
 FUSE RATING: 350A

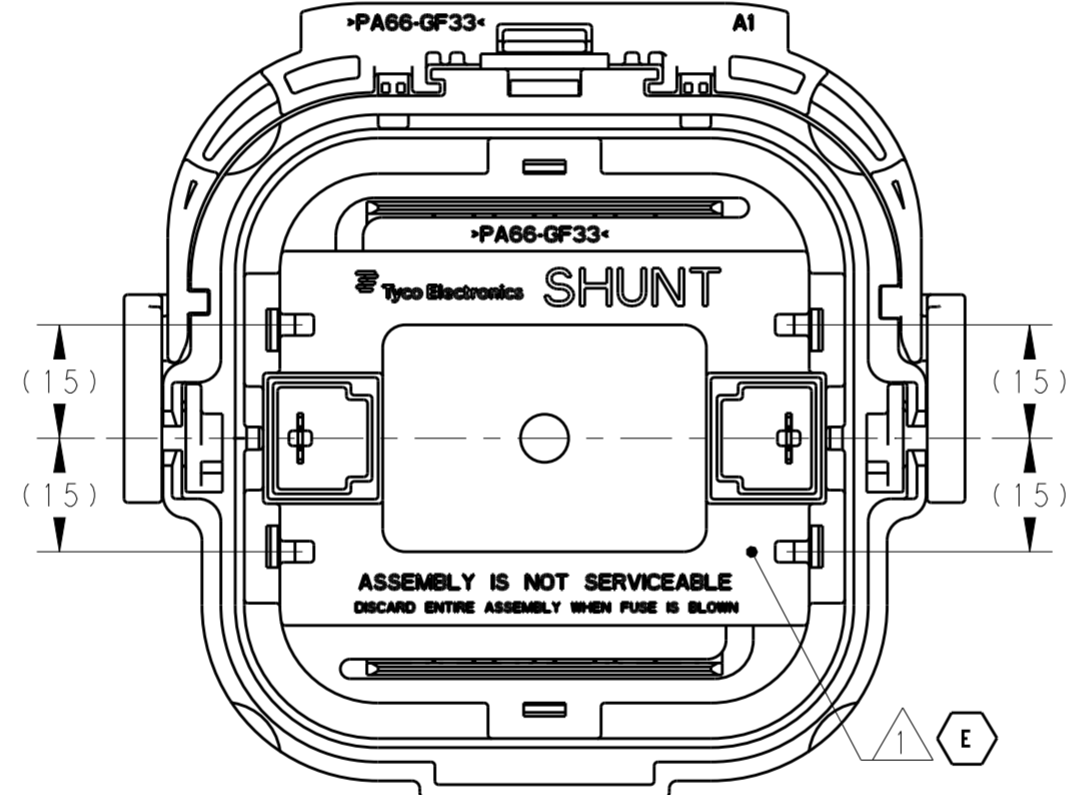

1-2103212-7 & 2-2103212-7
 SHUNT

THIS DRAWING IS A CONTROLLED DOCUMENT. DIMENSIONING AND TOLERANCING PER ASME Y14.5M-2009		DWN A BOYER 14 JUL 2011	TE Connectivity
DIMENSIONS: mm		CHK A BOYER 14 JUL 2011	
TOLERANCES UNLESS OTHERWISE SPECIFIED:		APVD A GUANCO 14 JUL 2011	
0 PLC ± 1 PLC ± 2 PLC ± 3 PLC ± 4 PLC ± ANGLES ± FINISH -		PRODUCT SPEC 2 APPLICATION SPEC 2 WEIGHT SEE TABLE CUSTOMER DRAWING	
MATERIAL -		NAME PLUG ASSEMBLY MANUAL SERVICE DISCONNECT	RESTRICTED TO
		SIZE A200779	CAGE CODE C-2103212
		SCALE 1:1	SHEET 2 OF 2
		REV E2	