



Chipsmall Limited consists of a professional team with an average of over 10 year of expertise in the distribution of electronic components. Based in Hongkong, we have already established firm and mutual-benefit business relationships with customers from,Europe,America and south Asia,supplying obsolete and hard-to-find components to meet their specific needs.

With the principle of “Quality Parts,Customers Priority,Honest Operation,and Considerate Service”,our business mainly focus on the distribution of electronic components. Line cards we deal with include Microchip,ALPS,ROHM,Xilinx,Pulse,ON,Everlight and Freescale. Main products comprise IC,Modules,Potentiometer,IC Socket,Relay,Connector.Our parts cover such applications as commercial,industrial, and automotives areas.

We are looking forward to setting up business relationship with you and hope to provide you with the best service and solution. Let us make a better world for our industry!



Contact us

Tel: +86-755-8981 8866 Fax: +86-755-8427 6832

Email & Skype: info@chipsmall.com Web: www.chipsmall.com

Address: A1208, Overseas Decoration Building, #122 Zhenhua RD., Futian, Shenzhen, China



© 1967 BY AMP INCORPORATED. ALL RIGHTS RESERVED. AMP PRODUCTS COVERED BY PATENTS AND/OR PATENTS PENDING. APPROVED PER GOVT CONTRACT NO.

LOCATION FOR AMP-TAB FEMALE CONTACT

CAVITY IDENTIFICATION ON P/N (I)-582587-T ONLY.

(I)-582587-1. SAME AS -1 EXCEPT TO HAVE CAVITY IDENT. ON TOP SURFACE OF HOUSING.

ZONE		LTR		DESCRIPTION	DATE	APPROVED
				ECO-08-020973	PY 11-08	JW

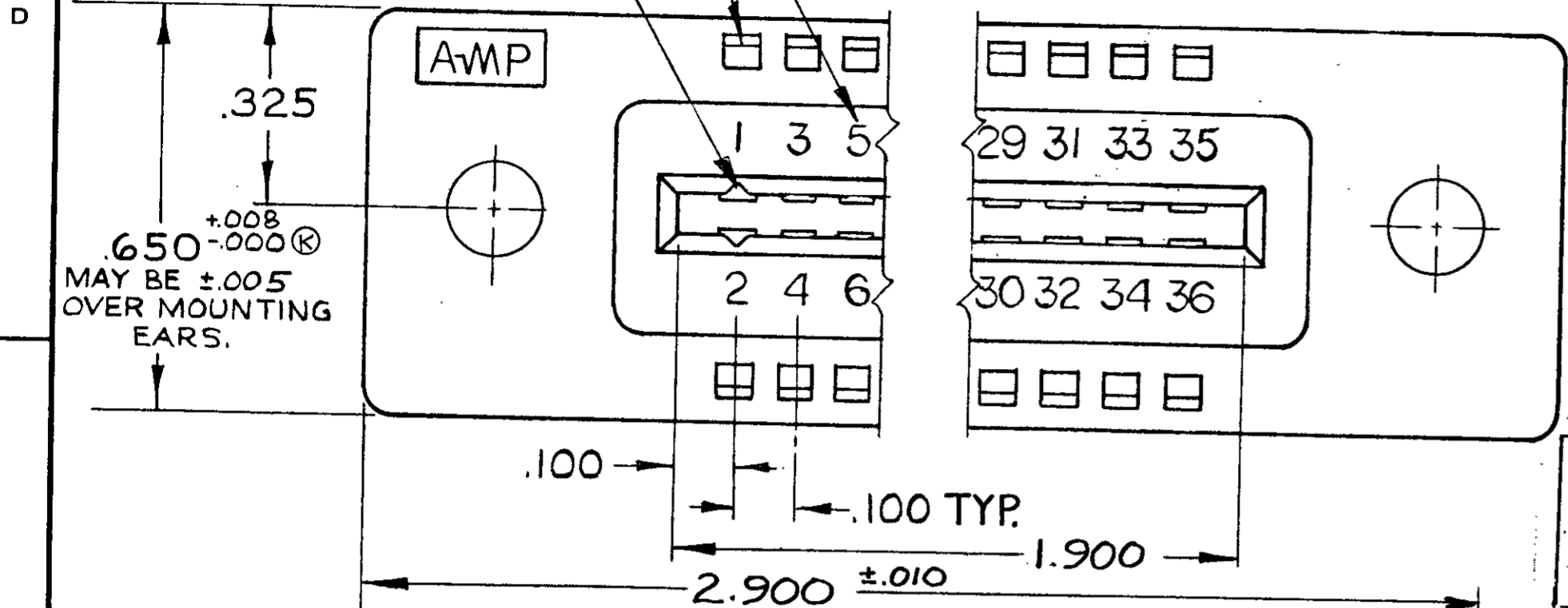

582587-1 1. AS SHOWN "J" DIA. HOLES = .128
 OBS 582587-2 1. SAME AS -1 EXCEPT: "J" DIA. HOLES = .156

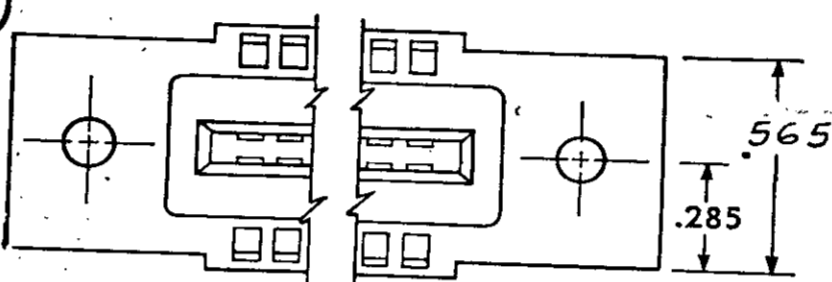

4. SAME AS -1 EXCEPT: OBSOLETE FLOATING BUSHINGS. (SEE DETAIL "B")
 5. SAME AS -1 EXCEPT: FLOATING BUSHINGS. (SEE DETAIL "C")

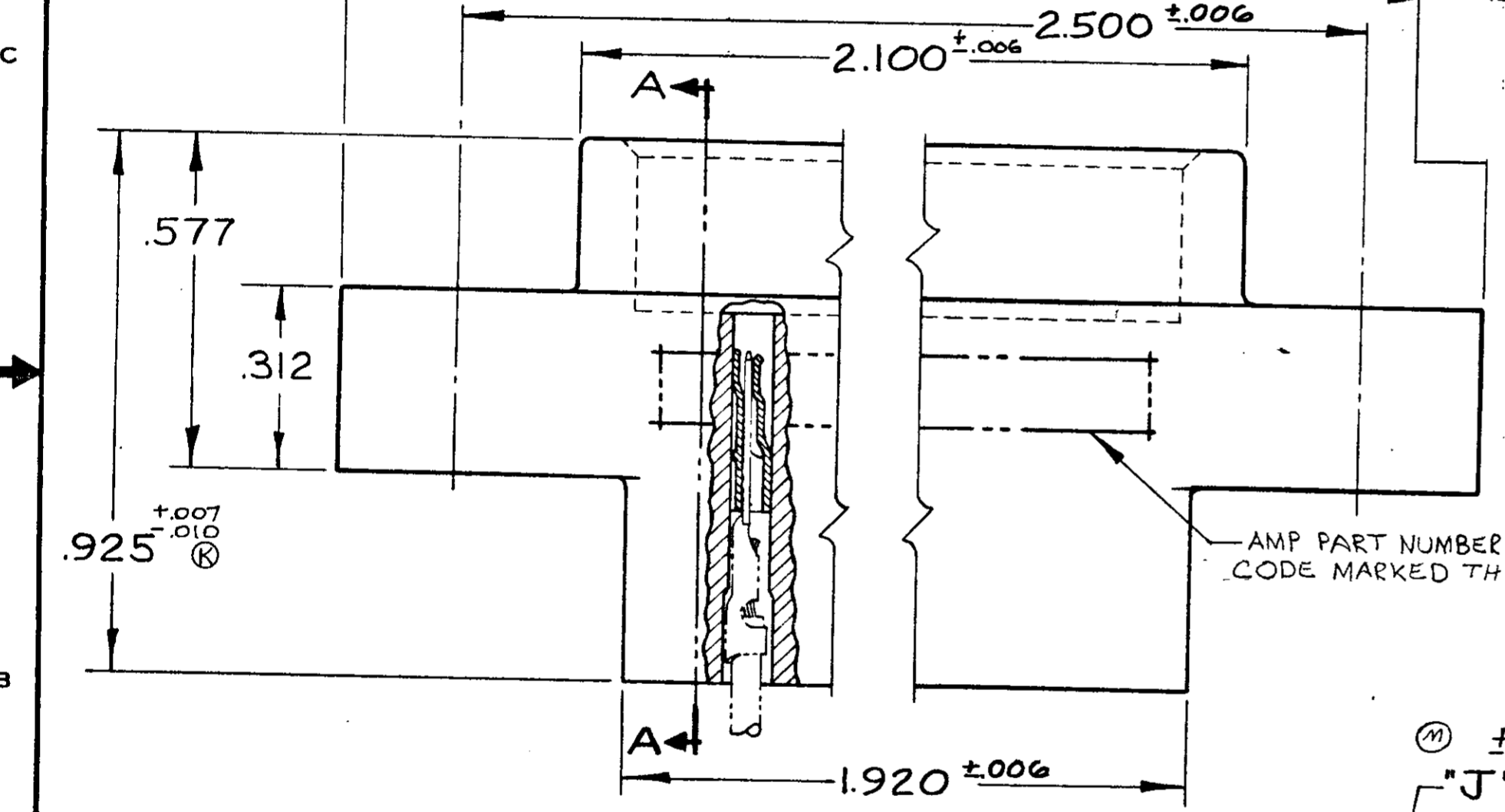

ALTERNATE MOUNTING EAR CONFIGURATION

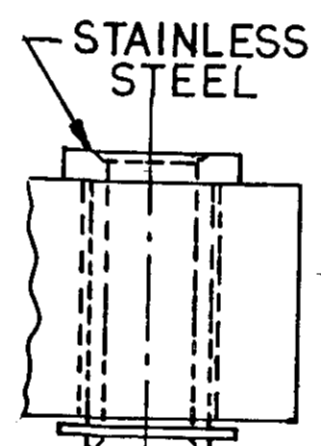

DETAIL "B"

FIT FOR #4-40 SCREW -4 ONLY

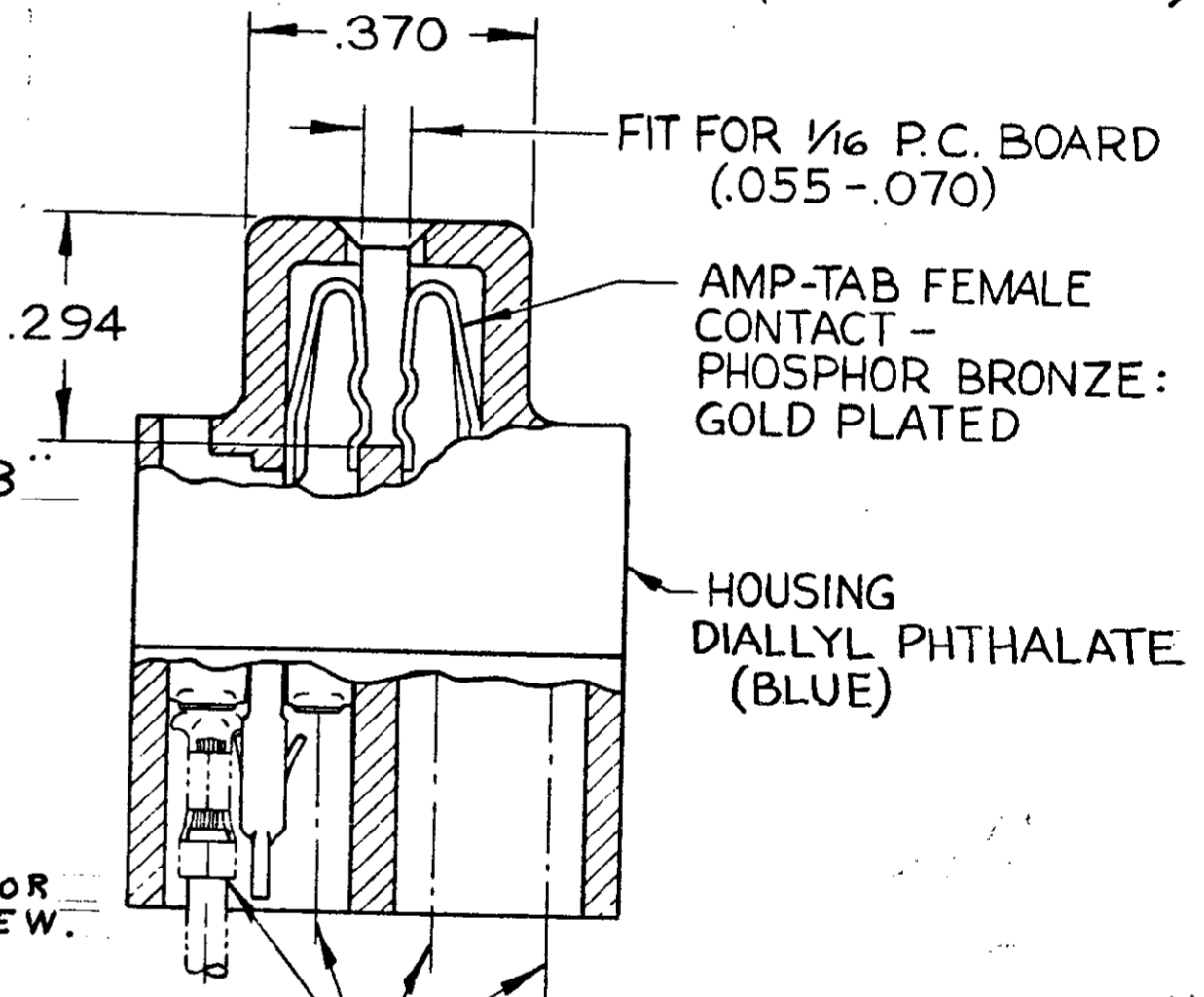

SECTION A-A

±.003 "J" DIA. HOLES

CLEARANCE FOR #4-40 SCREW.

DETAIL "C" -5 ONLY

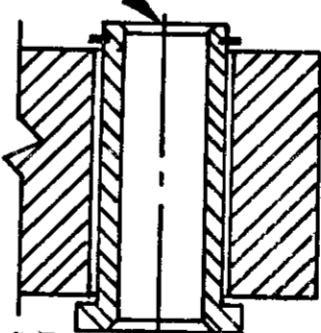

▲ GROOVES FOR "ON CONTACT KEYING" AMP'S OPTION DEPENDING ON METHOD OF MANUFACTURE. FOR "ON CONTACT" KEYING USE KEYING PLUG P/N 583487-1. (MUST BE ORDERED SEPARATELY.)
 ▲ MOUNTING EAR CONFIGURATION AMP'S OPTION DEPENDS ON METHOD OF MANUFACTURE.

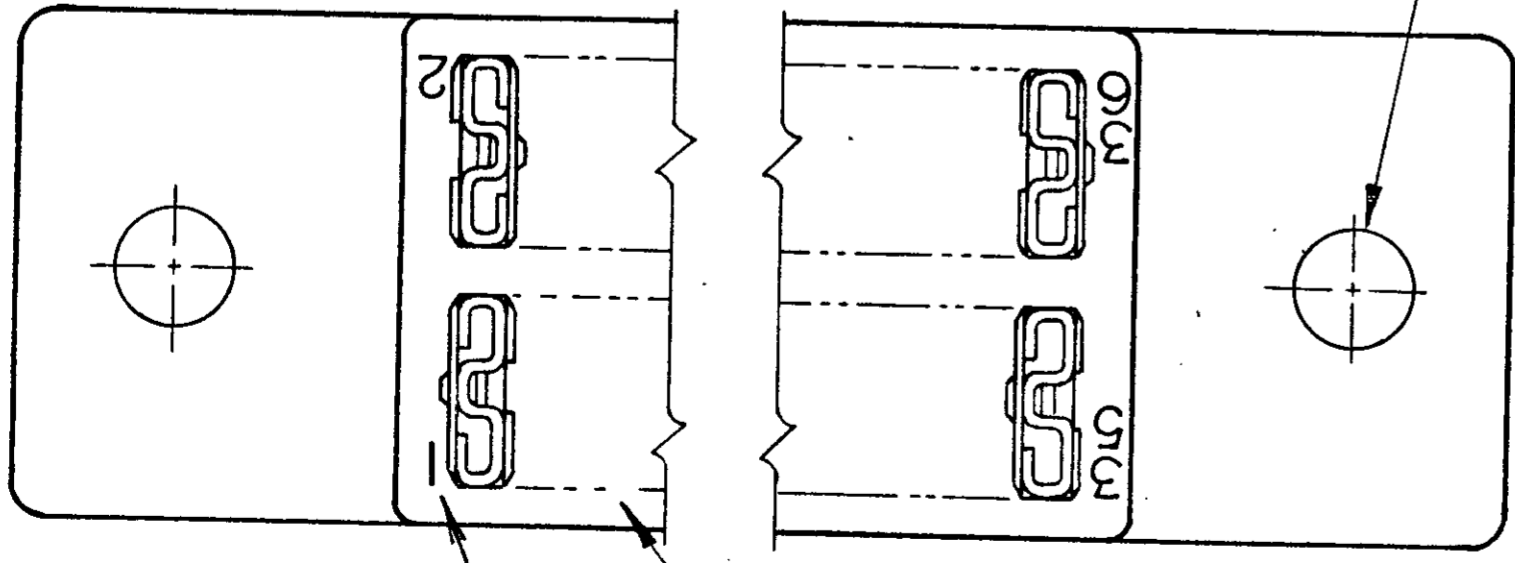

CIRCUIT CAVITY IDENTIFICATION MARKING PER MIL-C-21097 MARK FIRST 5 POSITIONS NEXT 5 POSITIONS PLAIN

3. LASER MARKING ACCEPTABLE FOR ALL MARKING

UNLESS OTHERWISE SPECIFIED DIMENSIONS ARE IN INCHES TOLERANCES ON		CONTRACT NO.		AMP INCORPORATED HARRISBURG, PENNSYLVANIA	
FRACTIONS	DECIMALS	DR	DATE	AMP TRADEMARK	
± .005	± .005	<i>J. Asick</i>	12-16-66	18 POSITION AMP-TAB CONNECTOR .100 CENTERS QUAD.	
ANGLES		CHK	DATE	SIZE	CODE IDENT NO
± .005		<i>W. Burns</i>	1-5-67	C	00779
MATERIAL		DSGN ENGR	DATE	NUMBER	582587
SEE CALLOUT		APPD	DATE	REV	T
HEAT TREAT		<i>S. Kaufman</i>	1-10-67	SCALE	4-1
SEE CALLOUT		DSGN APPD	DATE	WT	CALC
FINISH		<i>R. Showman</i>	1/10/67	ACTUAL	SHEET
SEE CALLOUT		OTHER APPD			

NUMBER CUS. 582587