



Chipsmall Limited consists of a professional team with an average of over 10 year of expertise in the distribution of electronic components. Based in Hongkong, we have already established firm and mutual-benefit business relationships with customers from,Europe,America and south Asia,supplying obsolete and hard-to-find components to meet their specific needs.

With the principle of "Quality Parts,Customers Priority,Honest Operation,and Considerate Service",our business mainly focus on the distribution of electronic components. Line cards we deal with include Microchip,ALPS,ROHM,Xilinx,Pulse,ON,Everlight and Freescale. Main products comprise IC,Modules,Potentiometer,IC Socket,Relay,Connector.Our parts cover such applications as commercial,industrial, and automotives areas.

We are looking forward to setting up business relationship with you and hope to provide you with the best service and solution. Let us make a better world for our industry!



## Contact us

Tel: +86-755-8981 8866 Fax: +86-755-8427 6832

Email & Skype: info@chipsmall.com Web: www.chipsmall.com

Address: A1208, Overseas Decoration Building, #122 Zhenhua RD., Futian, Shenzhen, China



# 1.5SMC6.8AT3G Series, SZ1.5SMC6.8AT3G Series

## 1500 Watt Peak Power Zener Transient Voltage Suppressors

### Unidirectional\*

The SMC series is designed to protect voltage sensitive components from high voltage, high energy transients. They have excellent clamping capability, high surge capability, low zener impedance and fast response time. The SMC series is supplied in ON Semiconductor's exclusive, cost-effective, highly reliable SURMETIC® package and is ideally suited for use in communication systems, automotive, numerical controls, process controls, medical equipment, business machines, power supplies and many other industrial/consumer applications.

### Specification Features

- Working Peak Reverse Voltage Range – 5.8 to 77.8 V
- Standard Zener Breakdown Voltage Range – 6.8 to 91 V
- Peak Power – 1500 W @ 1.0 ms
- ESD Rating of Class 3 (> 16 kV) per Human Body Model
- Maximum Clamp Voltage @ Peak Pulse Current
- Low Leakage < 5.0 µA Above 10 V
- UL 497B for Isolated Loop Circuit Protection
- Maximum Temperature Coefficient Specified
- Response Time is Typically < 1.0 ns
- SZ Prefix for Automotive and Other Applications Requiring Unique Site and Control Change Requirements; AEC-Q101 Qualified and PPAP Capable
- These are Pb-Free Devices are Available\*\*

### Mechanical Characteristics

**CASE:** Void-free, transfer-molded, thermosetting plastic

**FINISH:** All external surfaces are corrosion resistant and leads are readily solderable

**MAXIMUM CASE TEMPERATURE FOR SOLDERING PURPOSES:**  
260°C for 10 Seconds

**LEADS:** Modified L-Bend providing more contact area to bond pads

**POLARITY:** Cathode indicated by molded polarity notch

**MOUNTING POSITION:** Any

\* Bidirectional devices will not be available in this series.

\*\*For additional information on our Pb-Free strategy and soldering details, please download the ON Semiconductor Soldering and Mounting Techniques Reference Manual, SOLDERRM/D.



ON Semiconductor®

<http://onsemi.com>

**SURFACE MOUNT  
ZENER OVERVOLTAGE  
TRANSIENT SUPPRESSORS  
5.8 – 78 VOLTS  
1500 WATT PEAK POWER**



SMC  
CASE 403

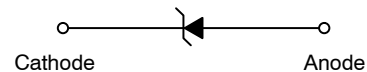

### MARKING DIAGRAM

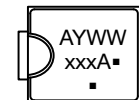

- xxxA = Specific Device Code  
(See Table on Page 3)
- A = Assembly Location
- Y = Year
- WW = Work Week
- = Pb-Free Package

(Note: Microdot may be in either location)

### ORDERING INFORMATION

Device***	Package	Shipping†
1.5SMCxxxAT3G	SMC (Pb-Free)	2,500 / Tape & Reel
SZ1.5SMCxxxAT3G	SMC (Pb-Free)	2,500 / Tape & Reel

\*\*\*The "T3" suffix refers to a 13 inch reel.

†For information on tape and reel specifications, including part orientation and tape sizes, please refer to our Tape and Reel Packaging Specifications Brochure, BRD8011/D.

Individual devices are listed on page 3 of this data sheet.

# 1.5SMC6.8AT3G Series, SZ1.5SMC6.8AT3G Series

## MAXIMUM RATINGS

Rating	Symbol	Value	Unit
Peak Power Dissipation (Note 1) @ $T_L = 25^\circ\text{C}$ , Pulse Width = 1 ms	$P_{PK}$	1500	W
DC Power Dissipation @ $T_L = 75^\circ\text{C}$ Measured Zero Lead Length (Note 2) Derate Above $75^\circ\text{C}$	$P_D$	4.0	W
Thermal Resistance, Junction-to-Lead	$R_{\theta JL}$	54.6 18.3	mW/ $^\circ\text{C}$ $^\circ\text{C}/\text{W}$
DC Power Dissipation (Note 3) @ $T_A = 25^\circ\text{C}$ Derate Above $25^\circ\text{C}$	$P_D$	0.75	W
Thermal Resistance from Junction-to-Ambient	$R_{\theta JA}$	6.1 165	mW/ $^\circ\text{C}$ $^\circ\text{C}/\text{W}$
Forward Surge Current (Note 4) @ $T_A = 25^\circ\text{C}$	$I_{FSM}$	200	A
Operating and Storage Temperature Range	$T_J, T_{stg}$	-65 to +150	$^\circ\text{C}$

Stresses exceeding those listed in the Maximum Ratings table may damage the device. If any of these limits are exceeded, device functionality should not be assumed, damage may occur and reliability may be affected.

- 10 X 1000  $\mu\text{s}$ , non-repetitive
- 1 in. square copper pad, FR-4 board
- FR-4 board, using ON Semiconductor minimum recommended footprint, as shown in 403 case outline dimensions spec.
- 1/2 sine wave (or equivalent square wave), PW = 8.3 ms, duty cycle = 4 pulses per minute maximum.

## ELECTRICAL CHARACTERISTICS ( $T_A = 25^\circ\text{C}$ unless otherwise noted, $V_F = 3.5\text{ V Max.}$ @ $I_F$ (Note 5) = 100 A)

Symbol	Parameter
$I_{PP}$	Maximum Reverse Peak Pulse Current
$V_C$	Clamping Voltage @ $I_{PP}$
$V_{RWM}$	Working Peak Reverse Voltage
$I_R$	Maximum Reverse Leakage Current @ $V_{RWM}$
$V_{BR}$	Breakdown Voltage @ $I_T$
$I_T$	Test Current
$\Theta V_{BR}$	Maximum Temperature Coefficient of $V_{BR}$
$I_F$	Forward Current
$V_F$	Forward Voltage @ $I_F$

- 1/2 sine wave or equivalent, PW = 8.3 ms non-repetitive duty cycle

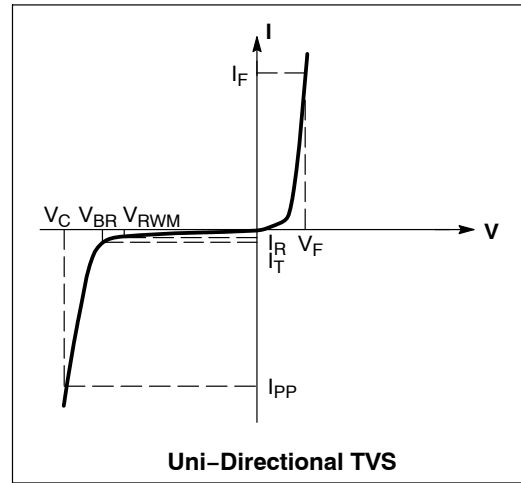

## 1.5SMC6.8AT3G Series, SZ1.5SMC6.8AT3G Series

### ELECTRICAL CHARACTERISTICS

Device*	Device Marking	V <sub>RWM</sub> (Note 6) V	I <sub>R</sub> @ V <sub>RWM</sub> μA	Breakdown Voltage				V <sub>C</sub> @ I <sub>PP</sub> (Note 8)		θV <sub>BR</sub> %/°C
				V <sub>BR</sub> V (Note 7)			@ I <sub>T</sub>	V <sub>C</sub>	I <sub>PP</sub>	
				Min	Nom	Max	mA	V	A	
1.5SMC6.8AT3G	6V8A	5.8	1000	6.45	6.8	7.14	10	10.5	143	0.057
1.5SMC7.5AT3G	7V5A	6.4	500	7.13	7.5	7.88	10	11.3	132	0.061
1.5SMC8.2AT3G	8V2A	7.02	200	7.79	8.2	8.61	10	12.1	124	0.065
1.5SMC10AT3G	10A	8.55	10	9.5	10	10.5	1	14.5	103	0.073
1.5SMC12AT3G	12A	10.2	5	11.4	12	12.6	1	16.7	90	0.078
1.5SMC13AT3G	13A	11.1	5	12.4	13	13.7	1	18.2	82	0.081
1.5SMC15AT3G	15A	12.8	5	14.3	15	15.8	1	21.2	71	0.084
1.5SMC16AT3G	16A	13.6	5	15.2	16	16.8	1	22.5	67	0.086
1.5SMC18AT3G	18A	15.3	5	17.1	18	18.9	1	25.2	59.5	0.088
1.5SMC20AT3G	20A	17.1	5	19	20	21	1	27.7	54	0.09
1.5SMC22AT3G	22A	18.8	5	20.9	22	23.1	1	30.6	49	0.092
1.5SMC24AT3G	24A	20.5	5	22.8	24	25.2	1	33.2	45	0.094
1.5SMC27AT3G	27A	23.1	5	25.7	27	28.4	1	37.5	40	0.096
1.5SMC30AT3G	30A	25.6	5	28.5	30	31.5	1	41.4	36	0.097
1.5SMC33AT3G	33A	28.2	5	31.4	33	34.7	1	45.7	33	0.098
1.5SMC36AT3G	36A	30.8	5	34.2	36	37.8	1	49.9	30	0.099
1.5SMC39AT3G	39A	33.3	5	37.1	39	41	1	53.9	28	0.1
1.5SMC43AT3G	43A	36.8	5	40.9	43	45.2	1	59.3	25.3	0.101
1.5SMC47AT3G	47A	40.2	5	44.7	47	49.4	1	64.8	23.2	0.101
1.5SMC51AT3G	51A	43.6	5	48.5	51	53.6	1	70.1	21.4	0.102
1.5SMC56AT3G	56A	47.8	5	53.2	56	58.8	1	77	19.5	0.103
1.5SMC62AT3G	62A	53	5	58.9	62	65.1	1	85	17.7	0.104
1.5SMC68AT3G	68A	58.1	5	64.6	68	71.4	1	92	16.3	0.104
1.5SMC75AT3G	75A	64.1	5	71.3	75	78.8	1	103	14.6	0.105
1.5SMC82AT3G	82A	70.1	5	77.9	82	86.1	1	113	13.3	0.105
1.5SMC91AT3G	91A	77.8	5	86.5	91	95.5	1	125	12	0.106

Product parametric performance is indicated in the Electrical Characteristics for the listed test conditions, unless otherwise noted. Product performance may not be indicated by the Electrical Characteristics if operated under different conditions.

6. A transient suppressor is normally selected according to the working peak reverse voltage (V<sub>RWM</sub>), which should be equal to or greater than the DC or continuous peak operating voltage level.

7. V<sub>BR</sub> measured at pulse test current I<sub>T</sub> at an ambient temperature of 25°C.

8. Surge current waveform per Figure 2 and derate per Figure 3 of the General Data – 1500 Watt at the beginning of this group.

\* Include SZ-prefix devices where applicable.

# 1.5SMC6.8AT3G Series, SZ1.5SMC6.8AT3G Series

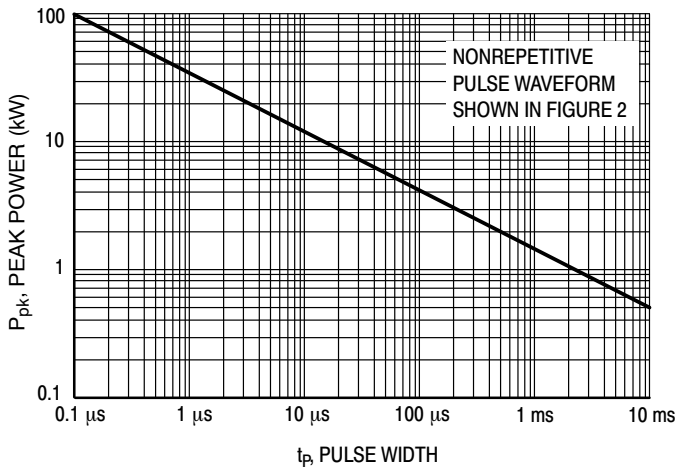

Figure 1. Pulse Rating Curve

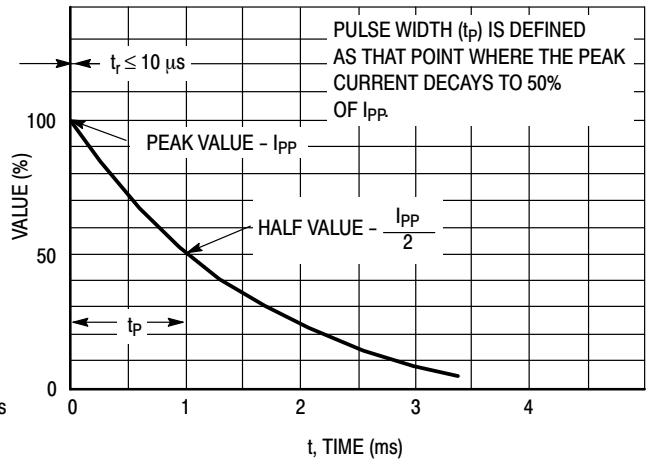

Figure 2. Pulse Waveform

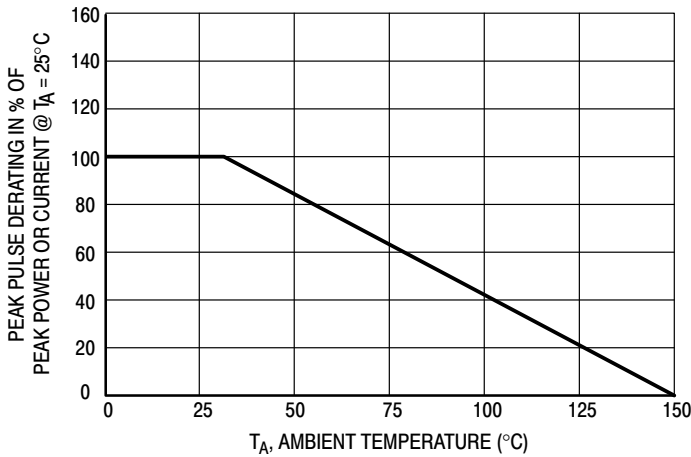

Figure 3. Pulse Derating Curve

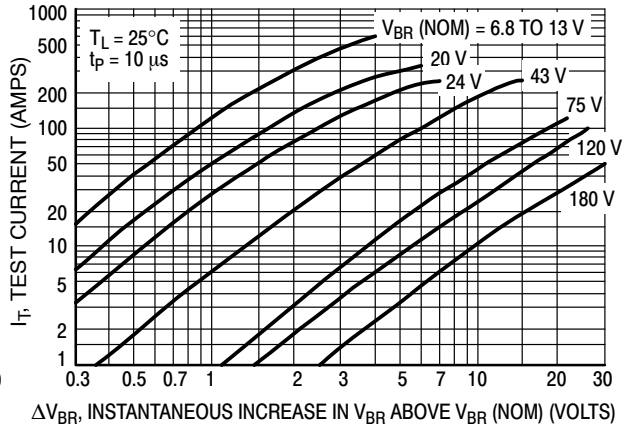

Figure 4. Dynamic Impedance

## UL RECOGNITION

The entire series has *Underwriters Laboratory Recognition* for the classification of protectors (QVGQ2) under the UL standard for safety 497B and File #E210057. Many competitors only have one or two devices recognized or have recognition in a non-protective category. Some competitors have no recognition at all. With the UL497B recognition, our parts successfully passed several tests

including Strike Voltage Breakdown test, Endurance Conditioning, Temperature test, Dielectric Voltage-Withstand test, Discharge test and several more.

Whereas, some competitors have only passed a flammability test for the package material, we have been recognized for much more to be included in their Protector category.

## APPLICATION NOTES

### Response Time

In most applications, the transient suppressor device is placed in parallel with the equipment or component to be protected. In this situation, there is a time delay associated with the capacitance of the device and an overshoot condition associated with the inductance of the device and the inductance of the connection method. The capacitive effect is of minor importance in the parallel protection scheme because it only produces a time delay in the transition from the operating voltage to the clamp voltage as shown in Figure 5.

The inductive effects in the device are due to actual turn-on time (time required for the device to go from zero current to full current) and lead inductance. This inductive effect produces an overshoot in the voltage across the equipment or component being protected as shown in Figure 6. Minimizing this overshoot is very important in the application, since the main purpose for adding a transient suppressor is to clamp voltage spikes. The SMC series have a very good response time, typically < 1.0 ns and negligible inductance. However, external inductive effects could produce unacceptable overshoot. Proper circuit layout,

minimum lead lengths and placing the suppressor device as close as possible to the equipment or components to be protected will minimize this overshoot.

Some input impedance represented by  $Z_{in}$  is essential to prevent overstress of the protection device. This impedance should be as high as possible, without restricting the circuit operation.

### Duty Cycle Derating

The data of Figure 1 applies for non-repetitive conditions and at a lead temperature of 25°C. If the duty cycle increases, the peak power must be reduced as indicated by the curves of Figure 7. Average power must be derated as the lead or ambient temperature rises above 25°C. The average power derating curve normally given on data sheets may be normalized and used for this purpose.

At first glance the derating curves of Figure 7 appear to be in error as the 10 ms pulse has a higher derating factor than the 10  $\mu$ s pulse. However, when the derating factor for a given pulse of Figure 7 is multiplied by the peak power value of Figure 1 for the same pulse, the results follow the expected trend.

# 1.5SMC6.8AT3G Series, SZ1.5SMC6.8AT3G Series

## TYPICAL PROTECTION CIRCUIT

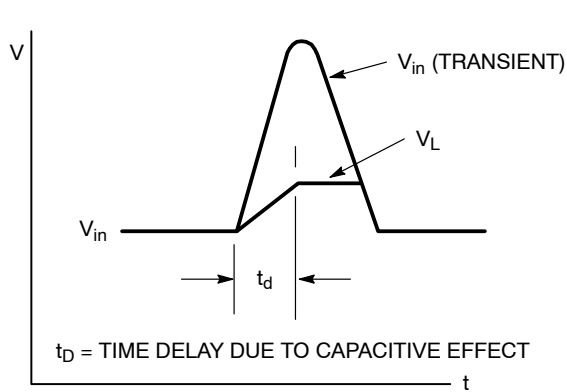
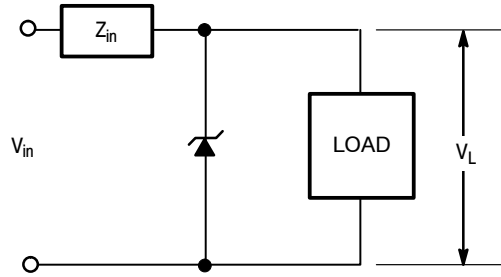

Figure 5.

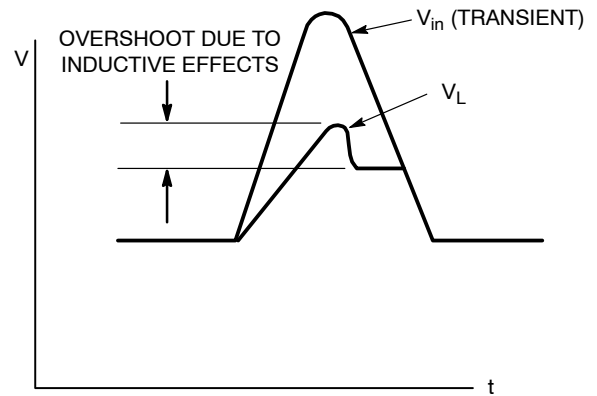

Figure 6.

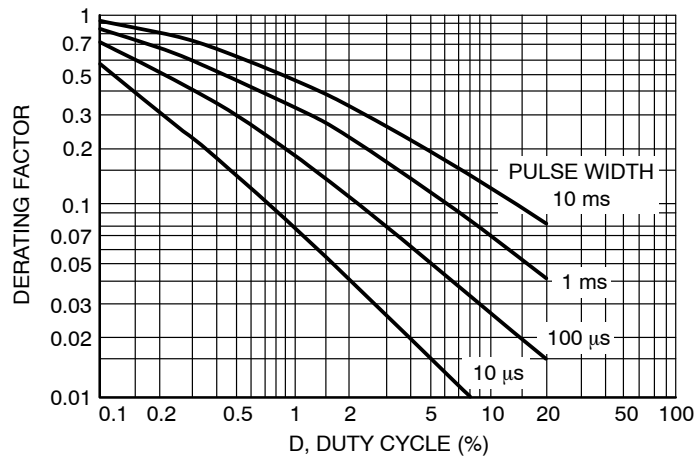
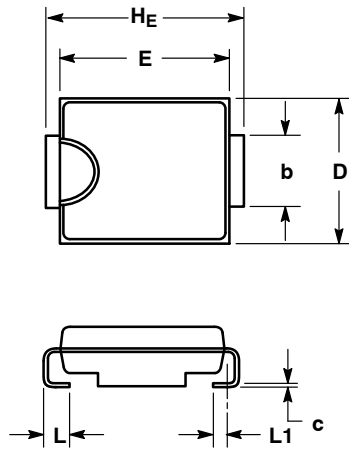

Figure 7. Typical Derating Factor for Duty Cycle

# 1.5SMC6.8AT3G Series, SZ1.5SMC6.8AT3G Series

## PACKAGE DIMENSIONS

SMC  
CASE 403-03  
ISSUE E



NOTES:

1. DIMENSIONING AND TOLERANCING PER ANSI Y14.5M, 1982.
2. CONTROLLING DIMENSION: INCH.
3. D DIMENSION SHALL BE MEASURED WITHIN DIMENSION P.
4. 403-01 THRU -02 OBSOLETE, NEW STANDARD 403-03.

DIM	MILLIMETERS			INCHES		
	MIN	NOM	MAX	MIN	NOM	MAX
A	1.90	2.13	2.41	0.075	0.084	0.095
A1	0.05	0.10	0.15	0.002	0.004	0.006
b	2.92	3.00	3.07	0.115	0.118	0.121
c	0.15	0.23	0.30	0.006	0.009	0.012
D	5.59	5.84	6.10	0.220	0.230	0.240
E	6.60	6.86	7.11	0.260	0.270	0.280
HE	7.75	7.94	8.13	0.305	0.313	0.320
L	0.76	1.02	1.27	0.030	0.040	0.050
L1	0.51 REF			0.020 REF		

### SOLDERING FOOTPRINT\*

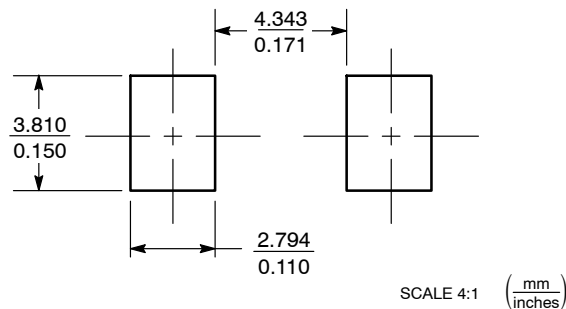

\*For additional information on our Pb-Free strategy and soldering details, please download the ON Semiconductor Soldering and Mounting Techniques Reference Manual, SOLDERRM/D.

SURMETIC is a registered trademark of Semiconductor Components Industries, LLC (SCILLC).

ON Semiconductor and  are registered trademarks of Semiconductor Components Industries, LLC (SCILLC). SCILLC reserves the right to make changes without further notice to any products herein. SCILLC makes no warranty, representation or guarantee regarding the suitability of its products for any particular purpose, nor does SCILLC assume any liability arising out of the application or use of any product or circuit, and specifically disclaims any and all liability, including without limitation special, consequential or incidental damages. "Typical" parameters which may be provided in SCILLC data sheets and/or specifications can and do vary in different applications and actual performance may vary over time. All operating parameters, including "Typicals" must be validated for each customer application by customer's technical experts. SCILLC does not convey any license under its patent rights nor the rights of others. SCILLC products are not designed, intended, or authorized for use as components in systems intended for surgical implant into the body, or other applications intended to support or sustain life, or for any other application in which the failure of the SCILLC product could create a situation where personal injury or death may occur. Should Buyer purchase or use SCILLC products for any such unintended or unauthorized application, Buyer shall indemnify and hold SCILLC and its officers, employees, subsidiaries, affiliates, and distributors harmless against all claims, costs, damages, and expenses, and reasonable attorney fees arising out of, directly or indirectly, any claim of personal injury or death associated with such unintended or unauthorized use, even if such claim alleges that SCILLC was negligent regarding the design or manufacture of the part. SCILLC is an Equal Opportunity/Affirmative Action Employer. This literature is subject to all applicable copyright laws and is not for resale in any manner.

### PUBLICATION ORDERING INFORMATION

**LITERATURE FULFILLMENT:**  
Literature Distribution Center for ON Semiconductor  
P.O. Box 5163, Denver, Colorado 80217 USA  
Phone: 303-675-2175 or 800-344-3860 Toll Free USA/Canada  
Fax: 303-675-2176 or 800-344-3867 Toll Free USA/Canada  
Email: orderlit@onsemi.com

**N. American Technical Support:** 800-282-9855 Toll Free  
USA/Canada  
**Europe, Middle East and Africa Technical Support:**  
Phone: 421 33 790 2910  
**Japan Customer Focus Center**  
Phone: 81-3-5817-1050

**ON Semiconductor Website:** [www.onsemi.com](http://www.onsemi.com)  
**Order Literature:** <http://www.onsemi.com/orderlit>

For additional information, please contact your local Sales Representative