



Chipsmall Limited consists of a professional team with an average of over 10 year of expertise in the distribution of electronic components. Based in Hongkong, we have already established firm and mutual-benefit business relationships with customers from,Europe,America and south Asia,supplying obsolete and hard-to-find components to meet their specific needs.

With the principle of “Quality Parts,Customers Priority,Honest Operation,and Considerate Service”,our business mainly focus on the distribution of electronic components. Line cards we deal with include Microchip,ALPS,ROHM,Xilinx,Pulse,ON,Everlight and Freescale. Main products comprise IC,Modules,Potentiometer,IC Socket,Relay,Connector.Our parts cover such applications as commercial,industrial, and automotives areas.

We are looking forward to setting up business relationship with you and hope to provide you with the best service and solution. Let us make a better world for our industry!



## Contact us

Tel: +86-755-8981 8866 Fax: +86-755-8427 6832

Email & Skype: info@chipsmall.com Web: www.chipsmall.com

Address: A1208, Overseas Decoration Building, #122 Zhenhua RD., Futian, Shenzhen, China



### Specifications:

connector description (1)	8P mini DIN female, molding style, brass, nickel plating, P/N 50-00168
overmold (2)	inner: PE; outer: 60P, PVC, black
wire description (3)	8C, 26 AWG, UL2464, 300V, 80C, 5.90 mm, shielded, VW-1, PVC, 60P, P/N 30-00065
cable outer diameter	Ø5.9 mm
cable color	black
cable length	1830 ± 50 mm
twist tie (4)	black
shrink tube (5)	Ø6.0, 105°C, 10 ± 2 mm, black
shrink tube (6)	Ø1.0, 105°C, 30 ± 5 mm, black
current rating	300 mA @ 12 Vdc

### Notes:

Function test: no open, no reversed polarity, no short circuit, no INT  
 RoHS compliant

### Mechanical drawing:

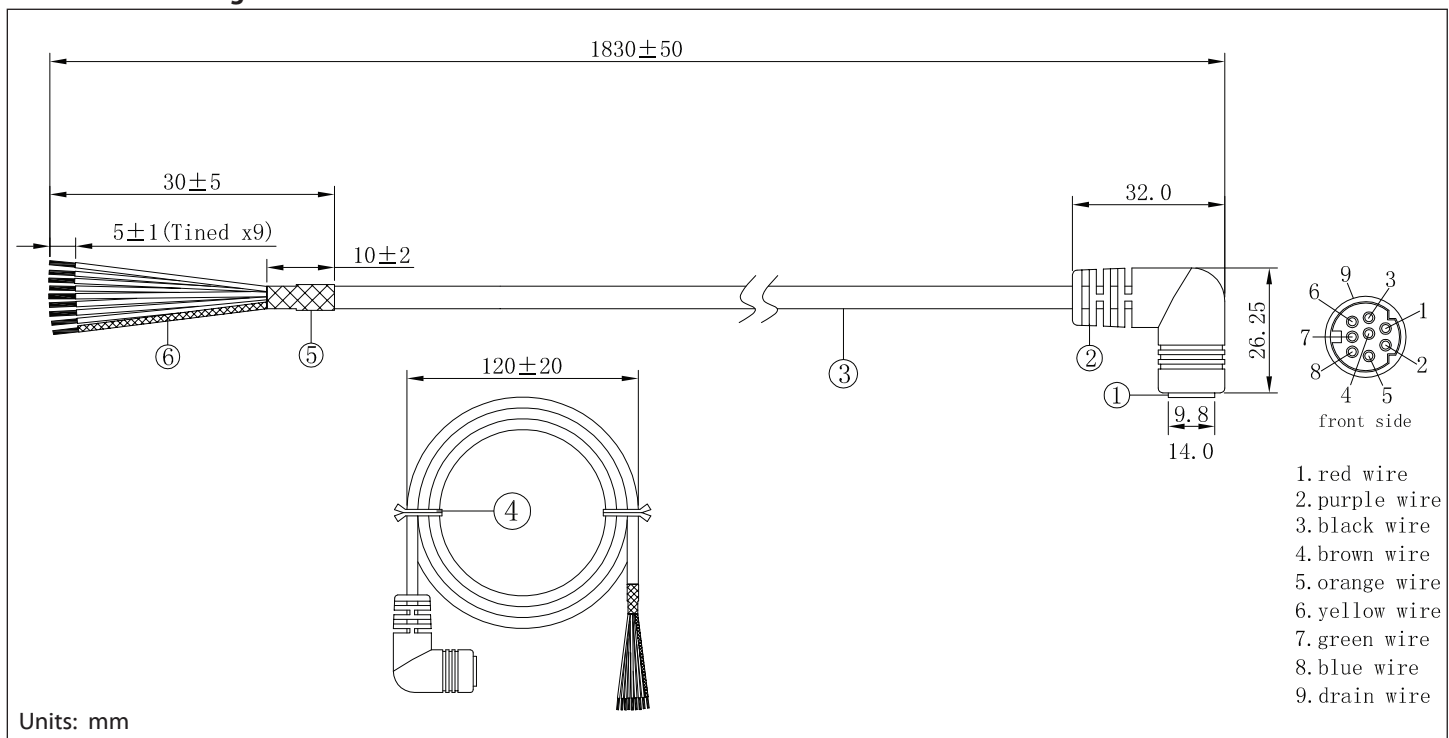

**tolerance X: ±0.5 mm .X: ±0.3 mm .XX: ±0.05 mm**  
 applicable unless otherwise indicated in specification or on drawings  
 Tensility International Corporation reserves the right to substitute  
 parts which are functionally equivalent to the ones specified.

Initial

Date

**Revision notes:**

Rev	Date	Description
A	March 10, 2011	initial release

**Specification Approval**

Spec sign-off verifies that you have reviewed the entire specification, tested a sample of the product, and confirm that it meets your requirements. This specification reflects the part as it will be ordered. Orders will not be processed until the specification pages have been initialed and the approval page has been signed. This specification is confidential and is not to be transmitted without prior approval from Tensility.

Signature \_\_\_\_\_

Title \_\_\_\_\_

Name \_\_\_\_\_

Date \_\_\_\_\_

Company \_\_\_\_\_

Branch \_\_\_\_\_